

The Transmission Electron Microscope

Karen M. Davies

Principal Beamline Scientist – eBIC,
Diamond Light Source Ltd, UK

Wellcome Trust Graduate Training Program - CryoEM

Outline

How a microscope works

Hardware of a transmission electron microscope:

Vacuum system

Electron source

Types of lenses

Apertures

How the microscope works:

Condenser system

Objective lens

Projection system

Aberrations and correctors

Detection system

Suggested Reading

Basic Image Formation

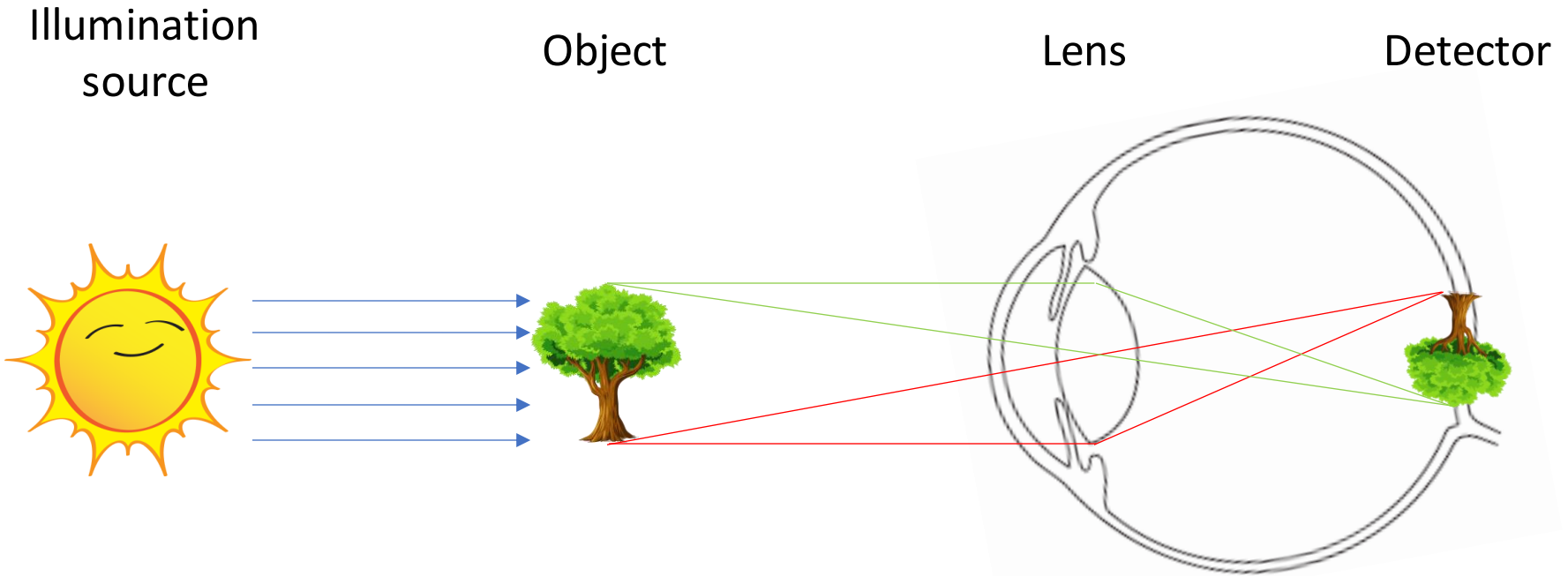

Lenses focus scattered rays back to the imaging plane

Images are formed by interference between the unscattered and elastically scattered waves

Resolution obtainable dependent on wavelength (λ) and numerical aperture (NA) of lenses

$$Res = \frac{0.61\lambda}{NA}$$

Abbe's equation

Human Eye vs. Microscope

Illumination source

Object

Lens

Detector

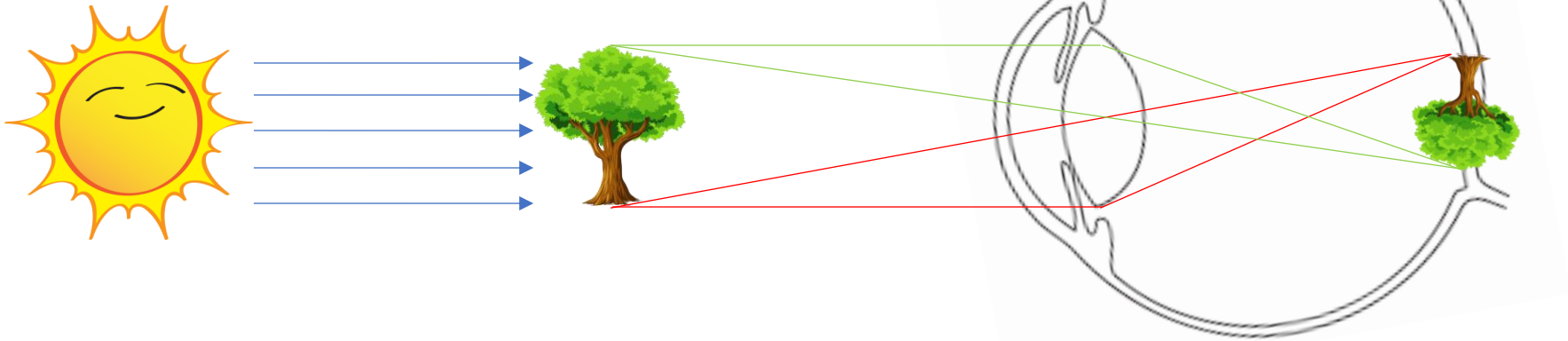

Microscope



Condenser lens
Focuses illumination
on object

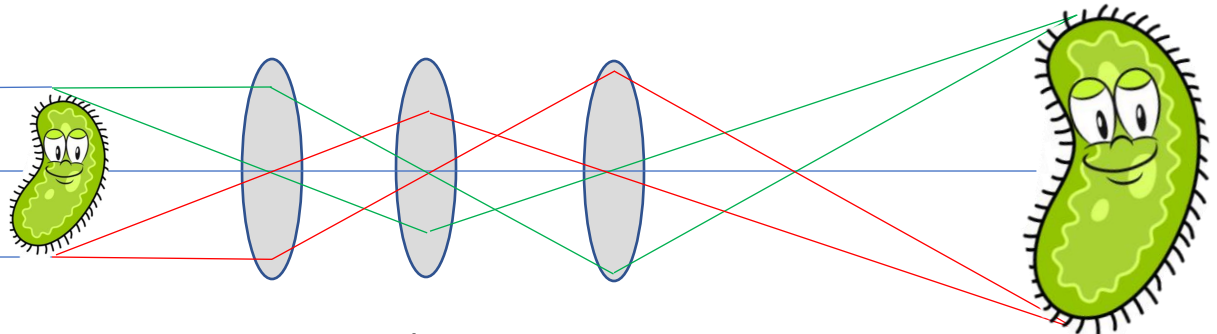

Objective/projector lenses
Magnifies object

Light vs. Electron Microscope

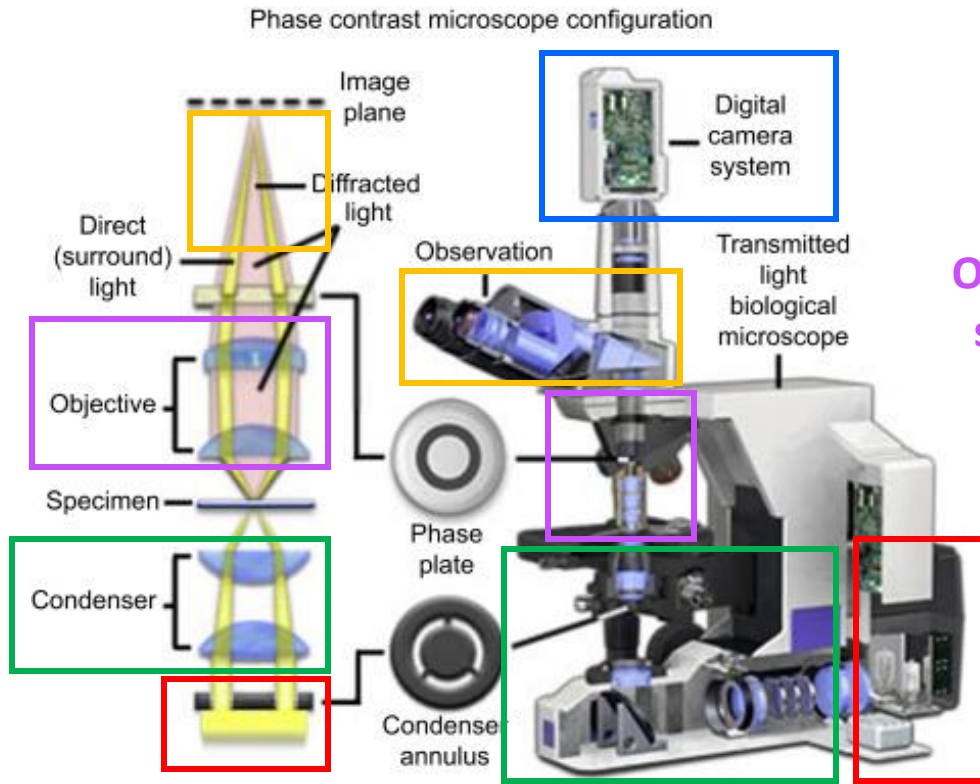

Light

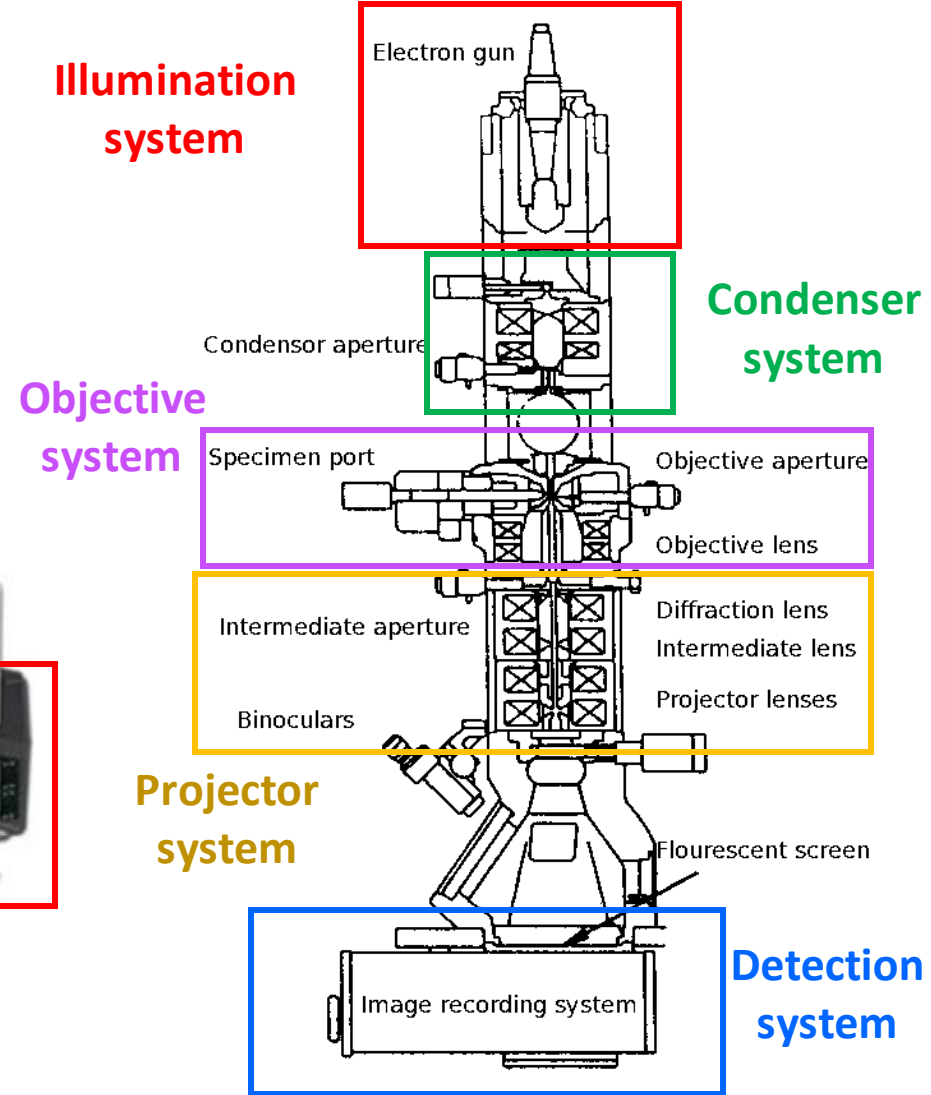

Electron

Electron Microscope & Vacuum System

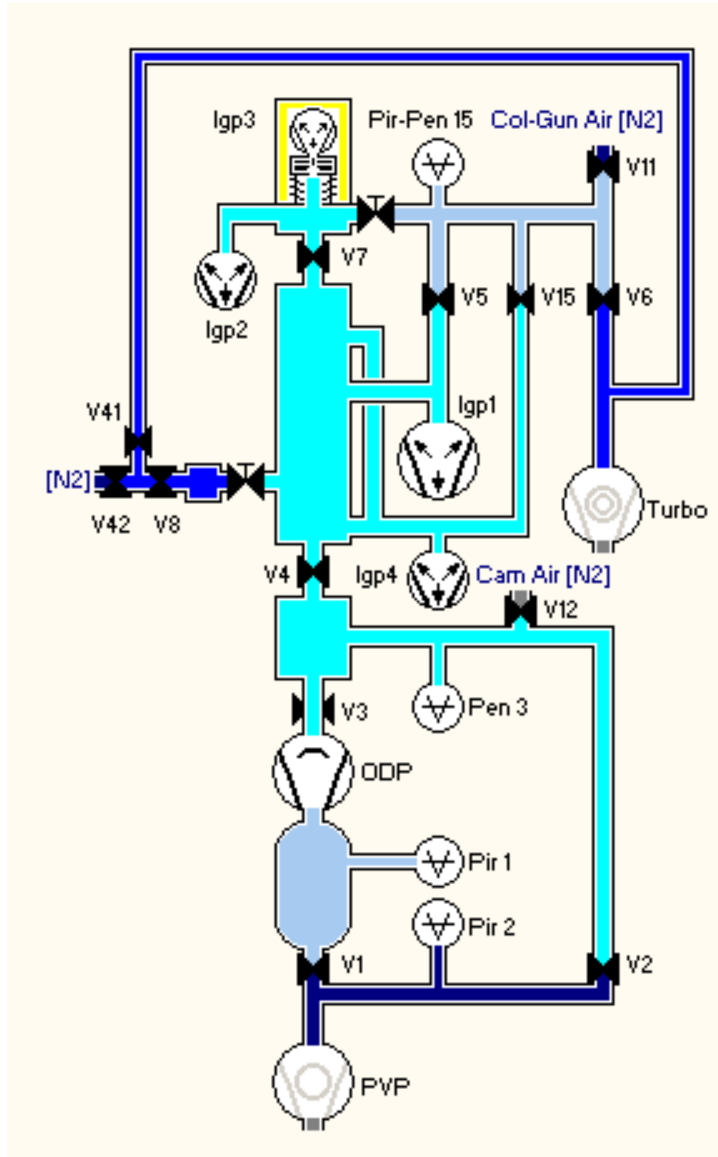

Vacuum system

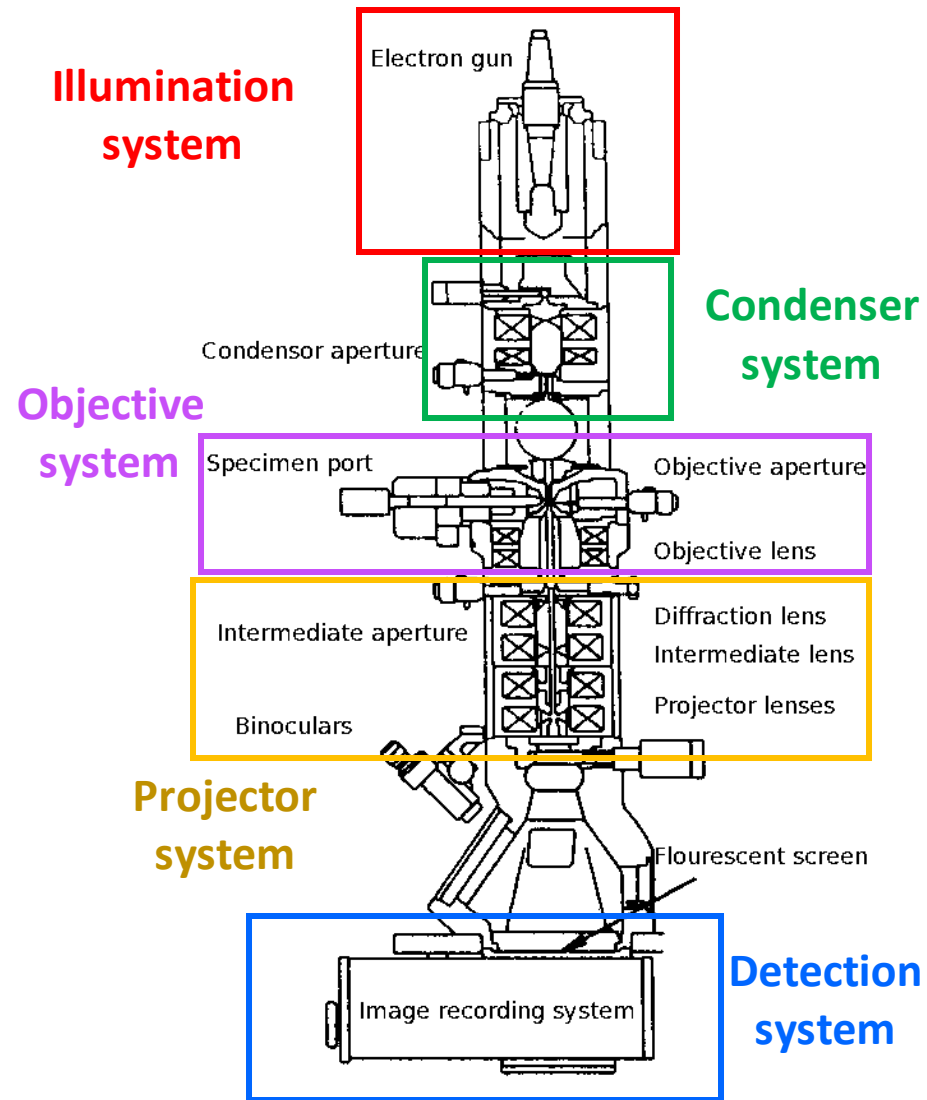

Electron

Electron Microscope & Vacuum System

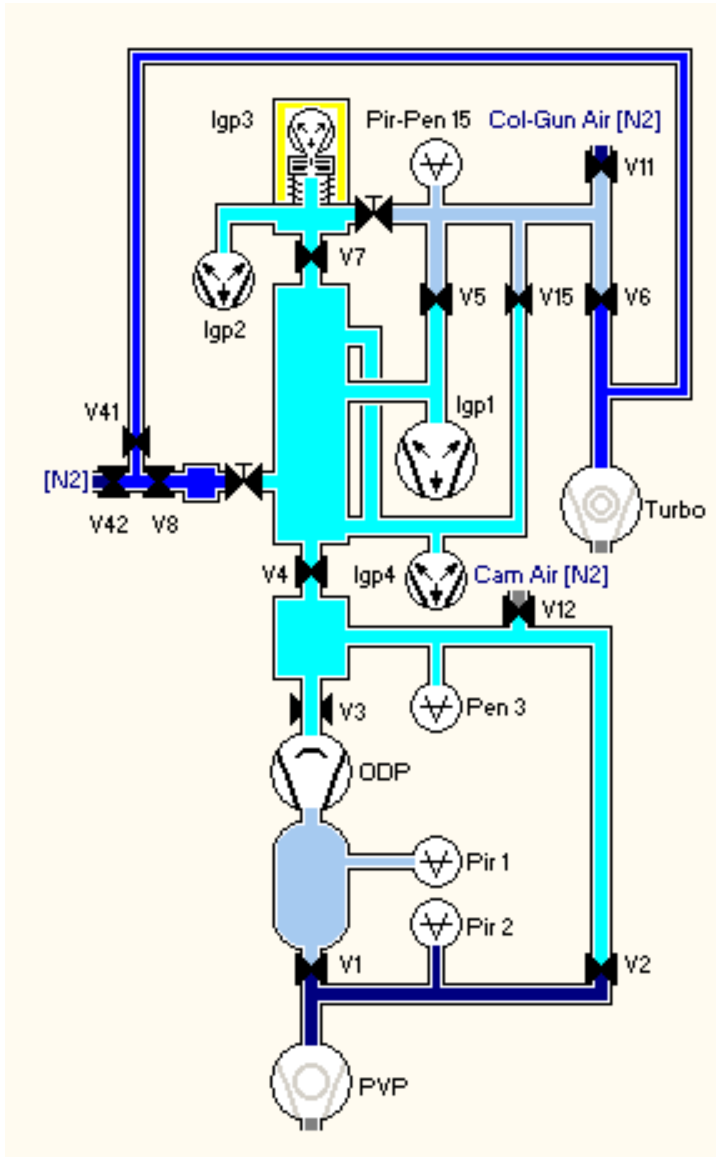

Vacuum system

Why operate in vacuum?

- Electrons interact well with matter
- Mean-free-path length: 20 cm in air
2 km in vacuum

How is vacuum achieved?

- Rotary pump (PVP) – ATM to rough vac.
- Oil diffusion pump (ODP) / Scroll Pump - low vac
- Turbo pump – high vacuum
- Ion getter pump (IGP) – ultra high vacuum
- Cryo-pump/trap – high vacuum

How is vacuum monitored?

- Pirani gauge (Pir) – ATM to low vac
- Penning gauge (Pen) – high vac
- Current readout (IGP) – ultra high vac

$$1\text{Pa} = 0.01\text{ mbar}$$

- Room Pressure: 10^5 Pa
- Rough Vacuum: 100-0.1 Pa
- Low Vacuum: $0.1 - 10^{-4}$
- High Vacuum: $10^{-4} - 10^{-7}$ Pa
- Ultra High Vacuum: 10^{-7} Pa and below

Vacuum System

Low vacuum

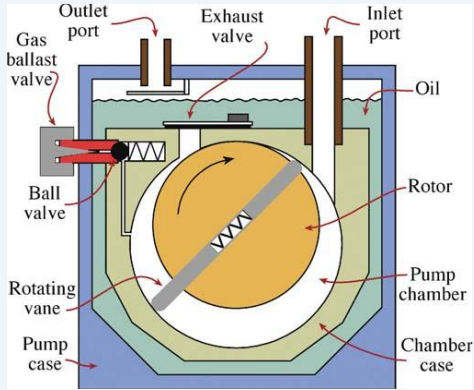

Rotary pump

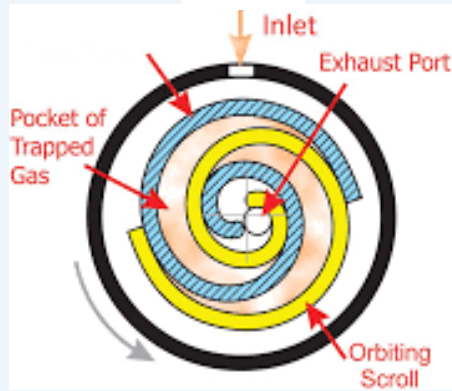

Scroll Pump

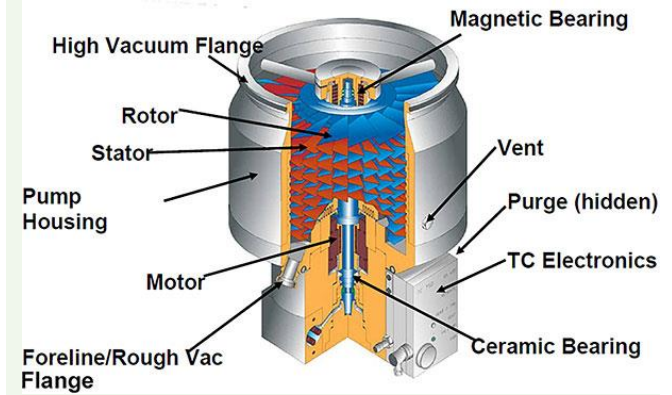

Turbo Pump

High vacuum

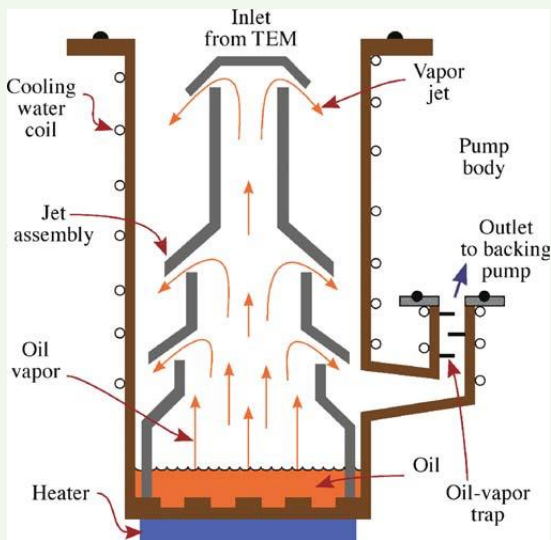

Oil Diffusion Pump

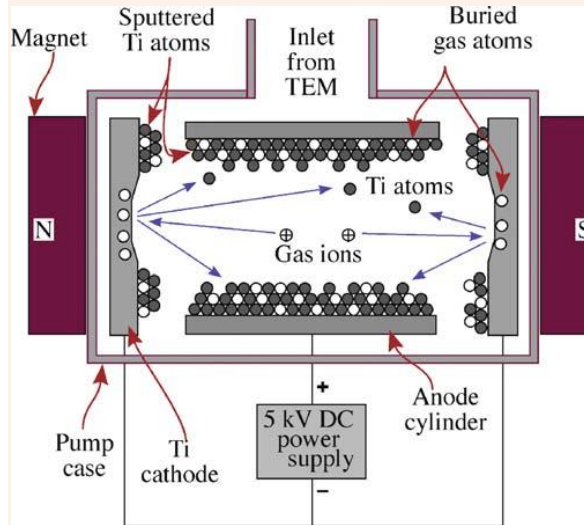

Ion Getter Pump

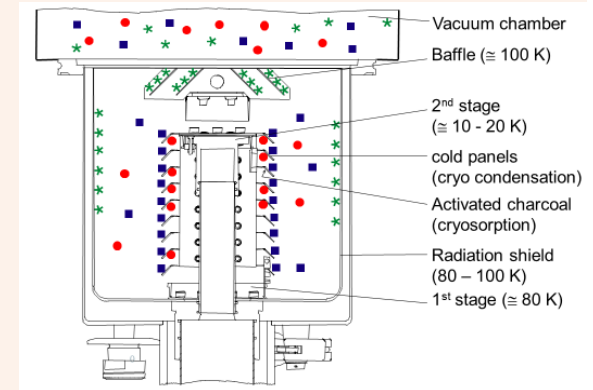

Cryo-pump

Electron Source

Thermionic

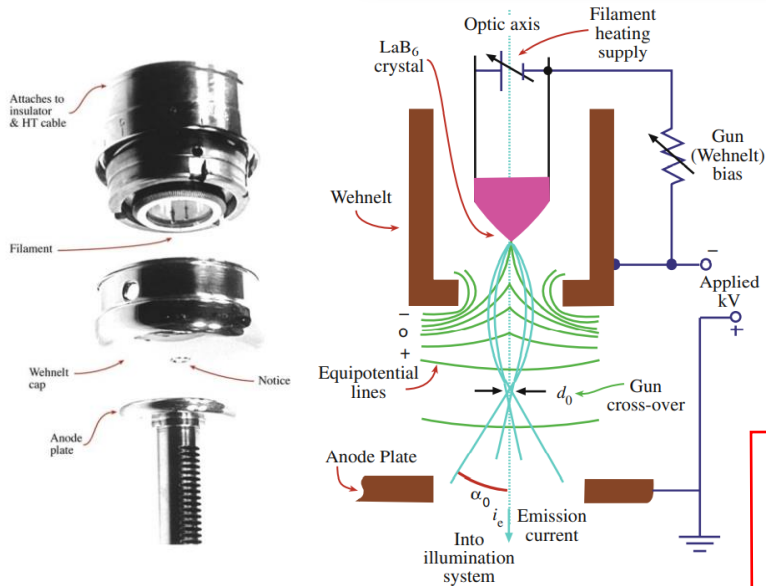

Field Emission

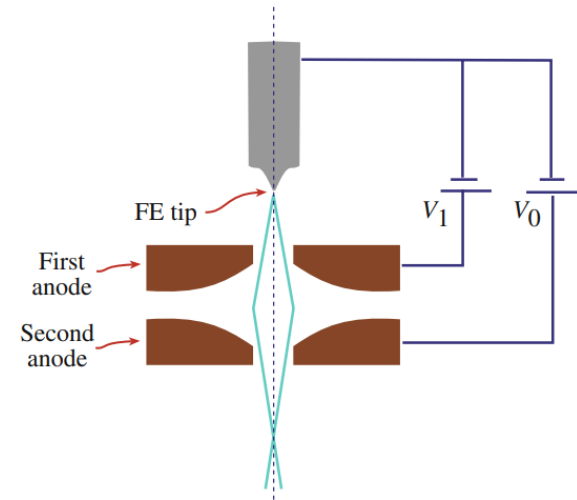

Gun quality:

Temporal coherence – Wavelength spread
Spatial coherence – Angular spread

	Units	Tungsten	LaB ₆	Schottky FEG	X-FEG	Cold FEG
Work function, Φ	eV	4.5	2.4	3.0		4.5
Richardson's constant	A/m ² K ²	6×10^9	4×10^9			
Operating temperature	K	2700	1700	1700		300
Current density (at 100 kV)	A/m ²	5	10^2	10^5		10^6
Crossover size	nm	$> 10^5$	10^4	15		3
Brightness (at 100 kV)	A/m ² sr	10^{10}	5×10^{11}	5×10^{12}		10^{13}
Energy spread (at 100 kV)	eV	3	1.5	0.7		0.3
Emission current stability	%/hr	<1	<1	<1		5
Vacuum	Pa	10^{-2}	10^{-4}	10^{-6}		10^{-9}
Lifetime	hr	100	1000	>5000		>5000
Cost of tip		£80	£800	£8000		£8000
Time to replace		1-2 days	1-2 days	5-8 days		5-8 days

Filaments

Tungsten (W)

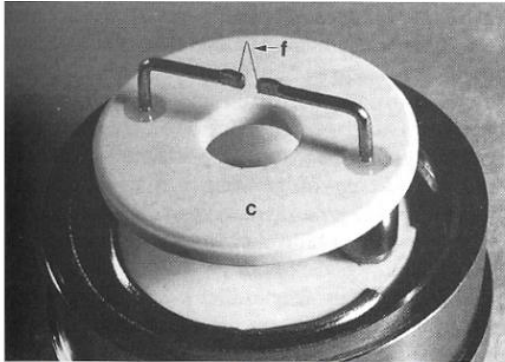

Bozzola and Russell, Fig. 6.22

LaB₆

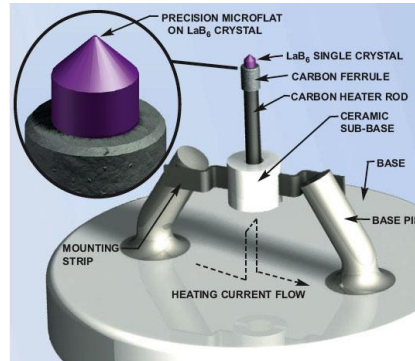

FEG (W)

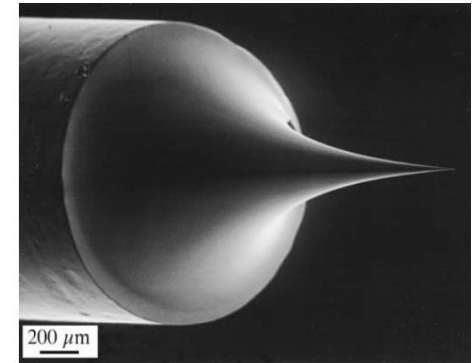
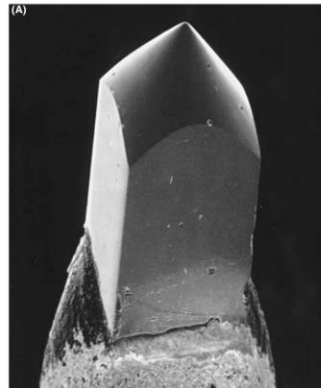
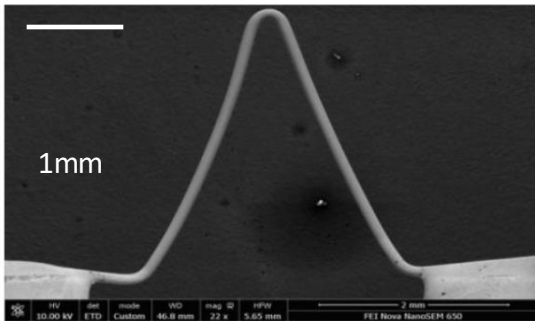
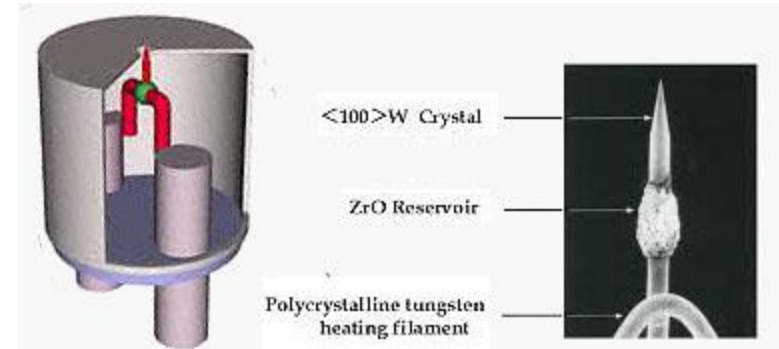

The Lens System

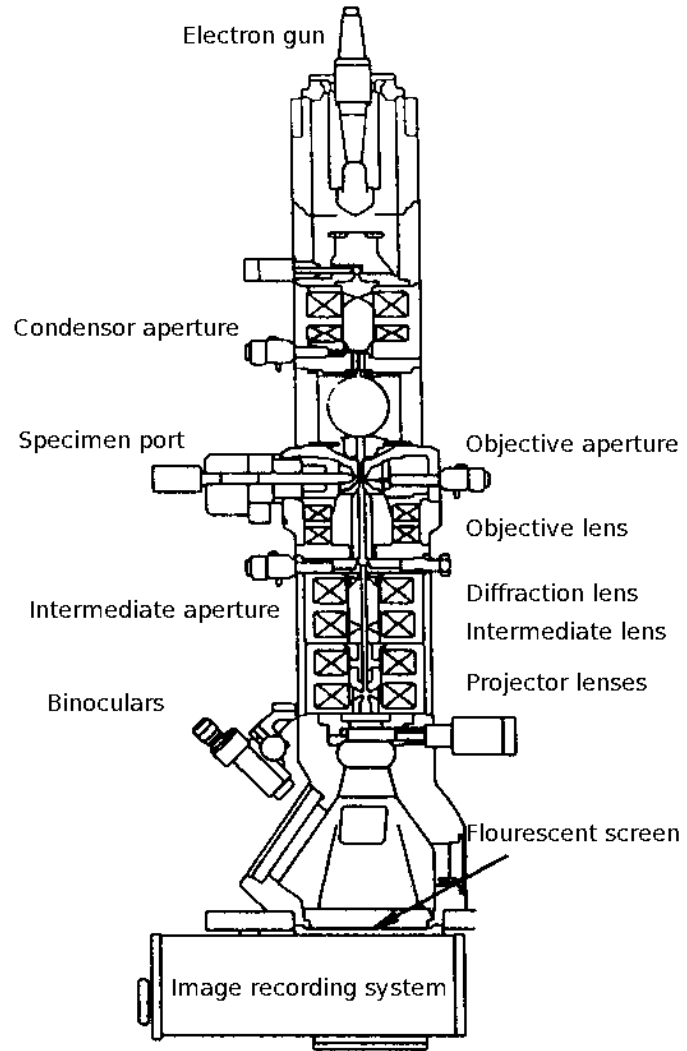

The Lens System

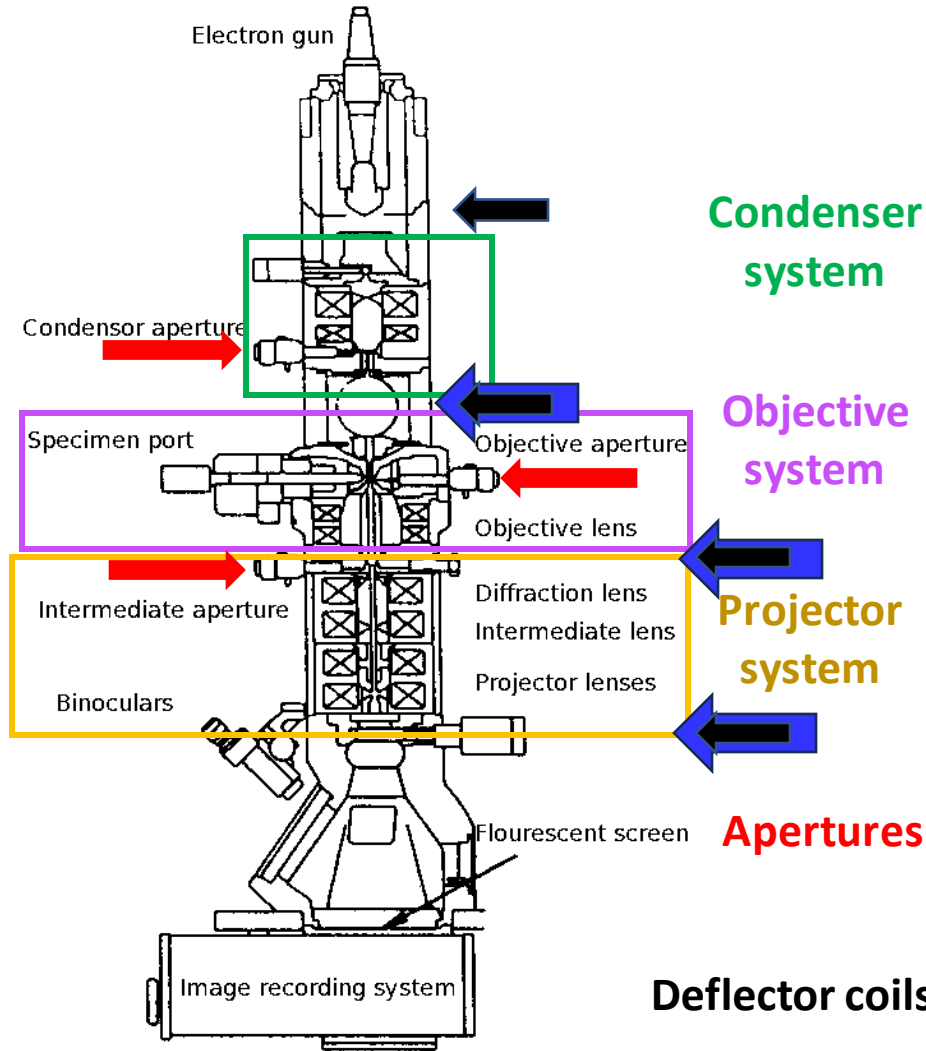

Condensing lenses

Focuses electrons on specimen
(controls illumination cone shape/intensity)

Main Magnification Lens
(magnifies sample, 80/100x)

Weaker magnification lenses
(magnifies sample, 2-10x)

Reduces beam intensity
Parallelizes beam
Increases amplitude contrast

Corrects beam location/angle (tilt/shift)

Corrects beam shape (stigmator)

Deflector coils

Quadrupoles

Apertures

The Imaging (Condensing) Lens

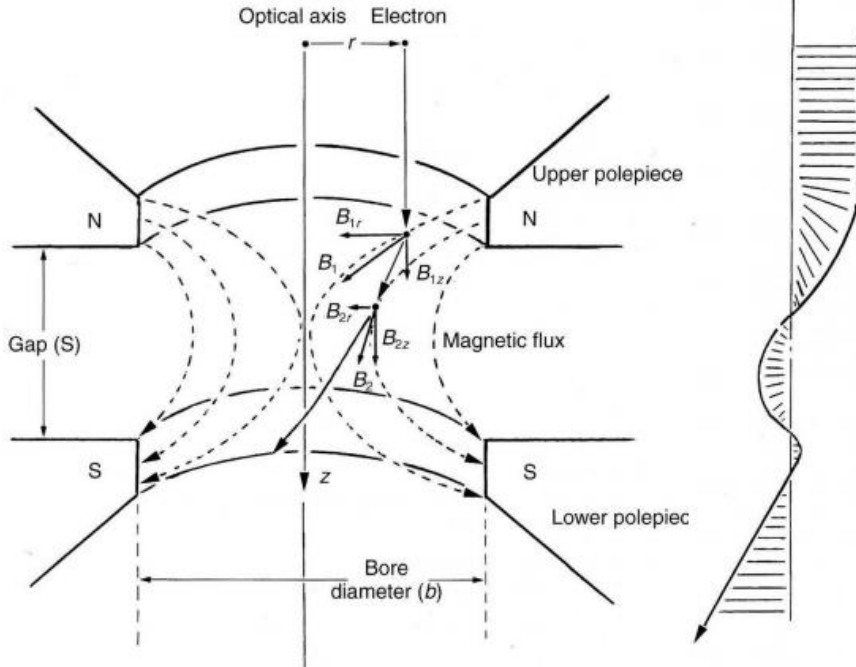
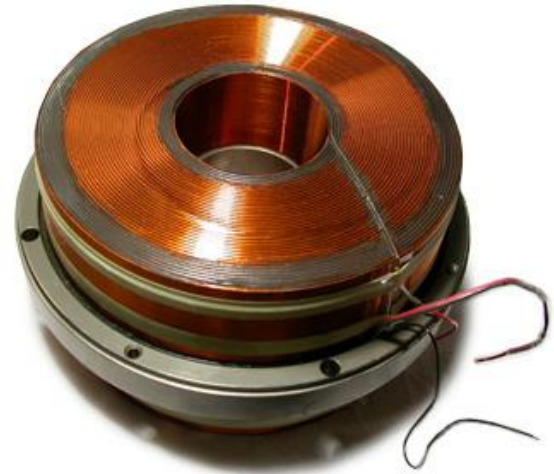
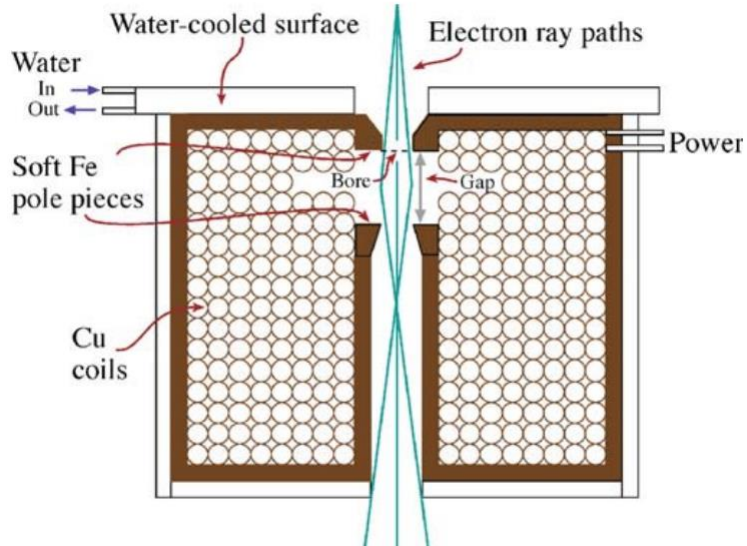

The Imaging (Condensing) Lens

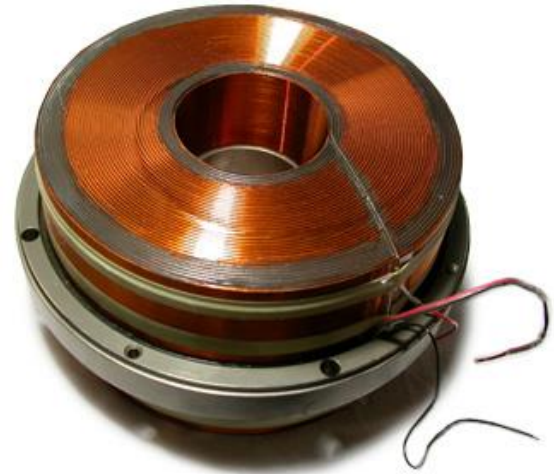
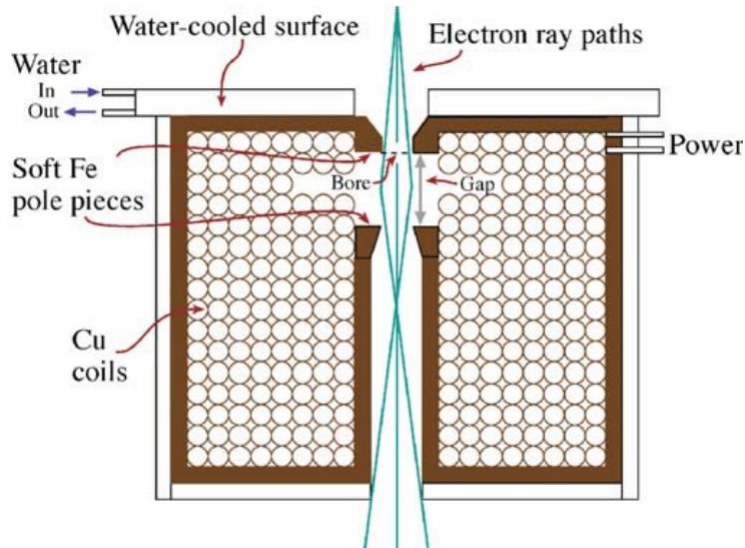

Magnetic lenses are poor quality and have severe aberrations:

Spherical aberration (position)

Chromatic aberration (wavelength)

Coma (angle of entry)

Stigmatism – defects in magnetic field symmetry

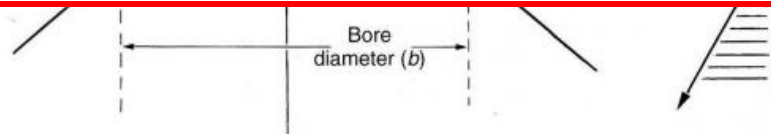

Quadrupoles = Stigmators

Stigmatism is caused by:

- 1) Magnetic lens defects
- 2) Contamination in pole gap

Condenser stigmators
correct beam shape
(circle vs. oval)

Objective stigmators
correct image

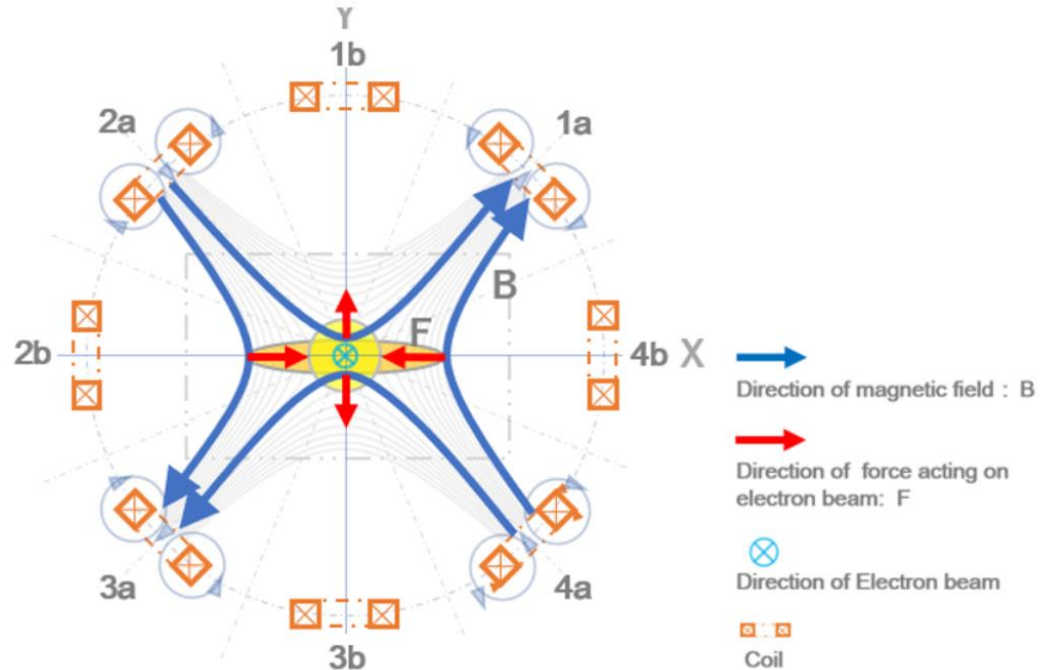
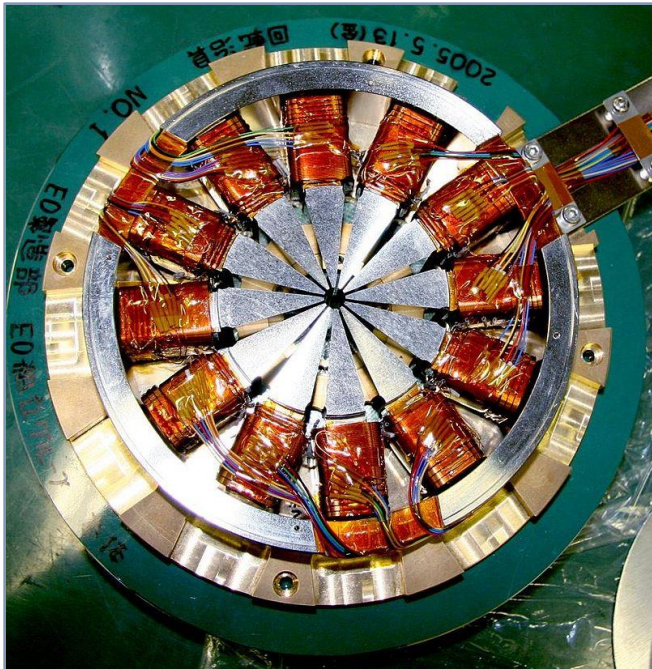
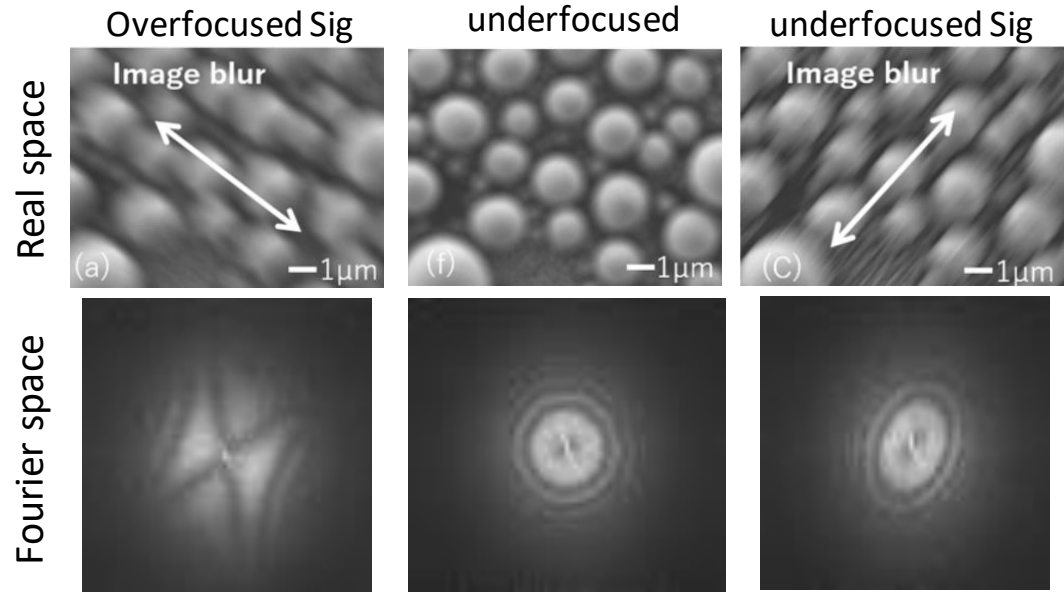

Shift/Tilt Coils

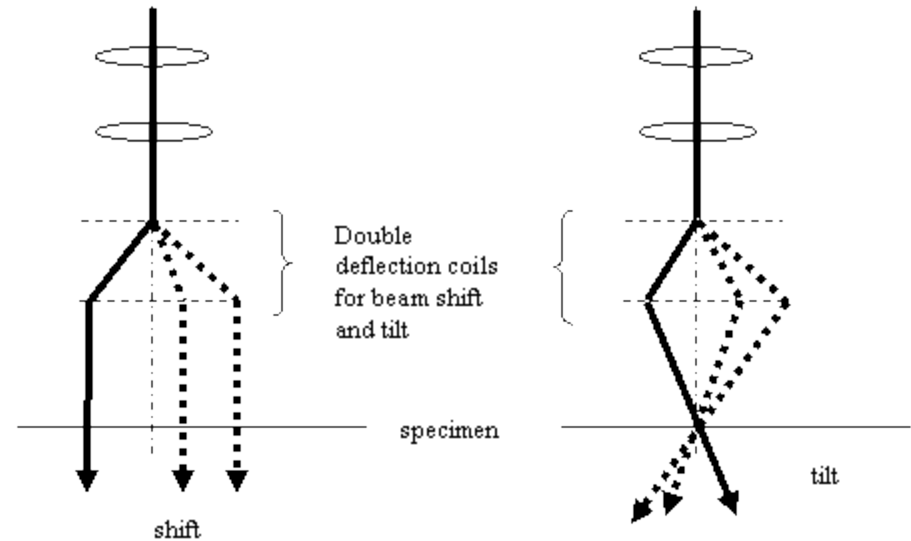
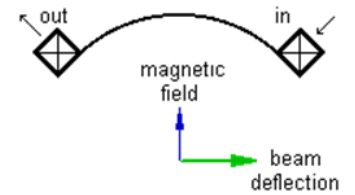
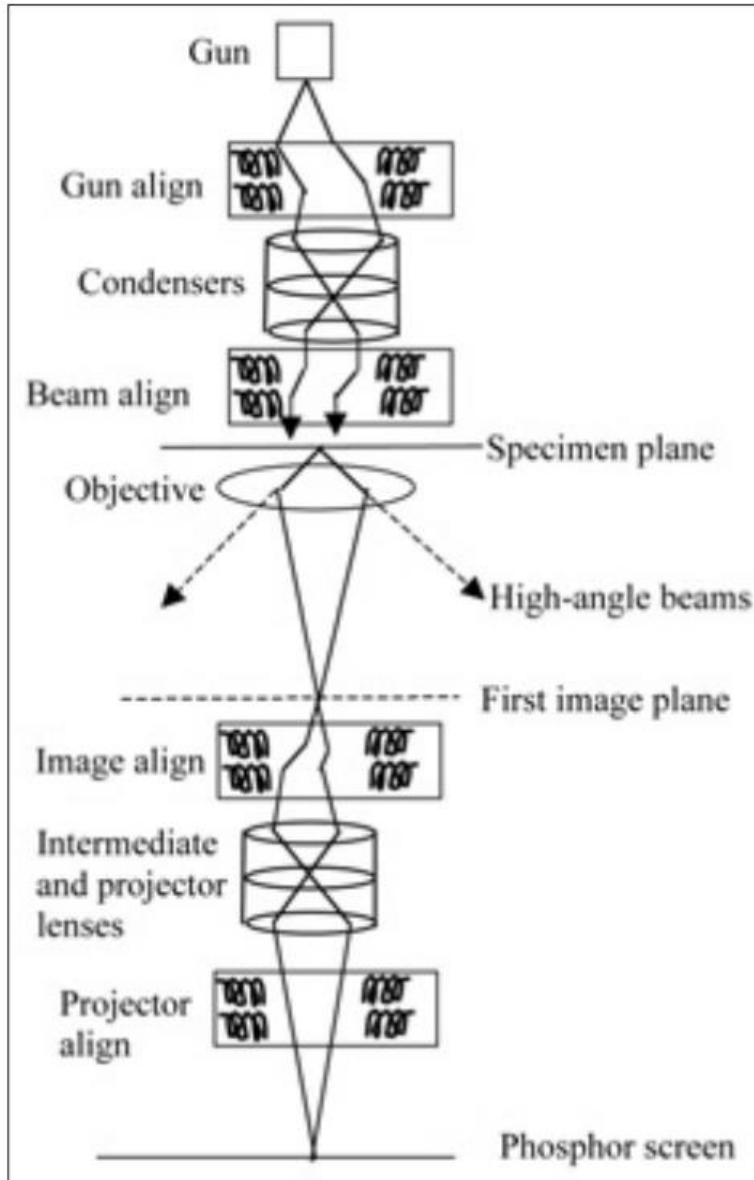

1. Get the beam down the scope
2. Make sure beam is parallel/aligned to optical axis (bright field imaging)
3. Low dose imaging
4. Automatic procedures (e.g. eucentric height/focus)

Use of Deflection Coils in Low Dose Imaging

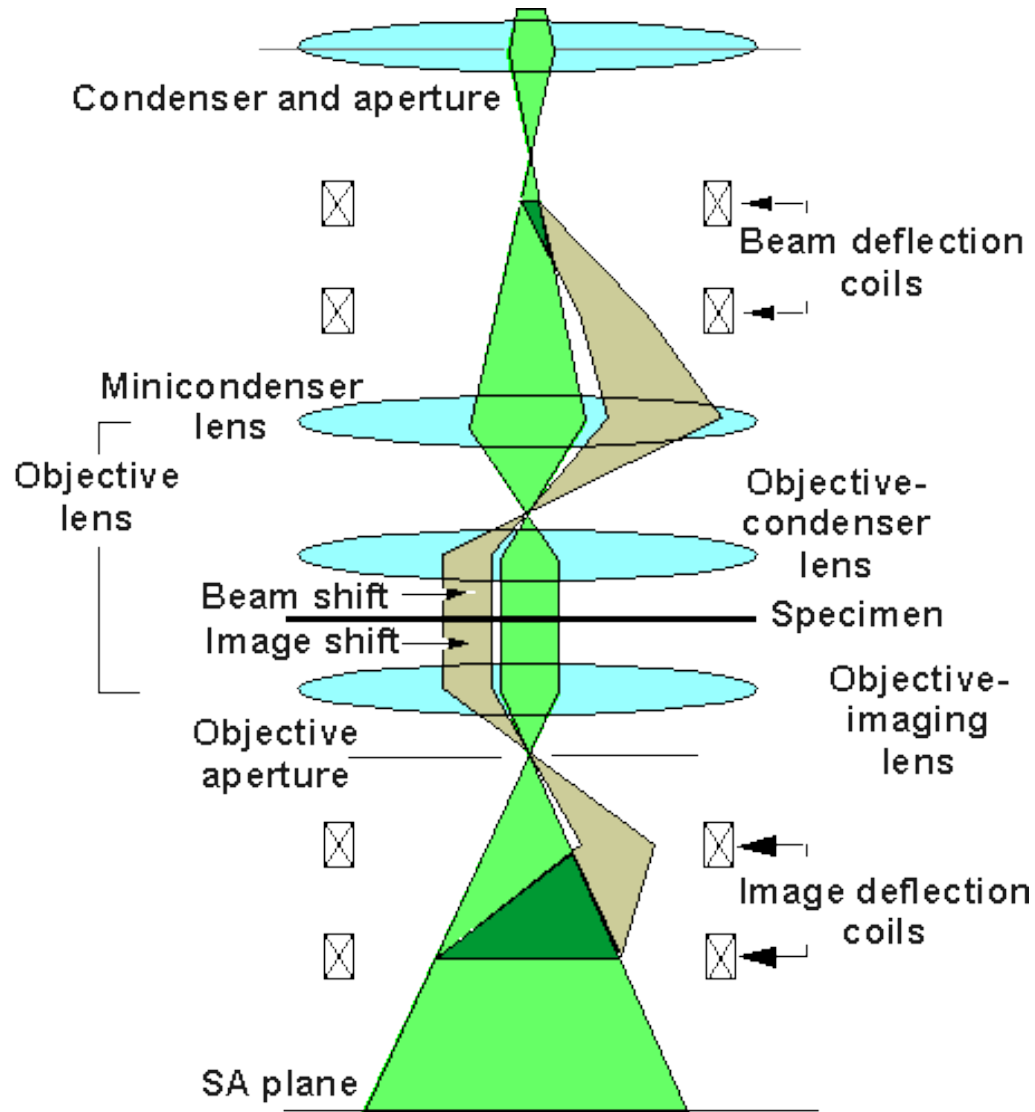

Apertures

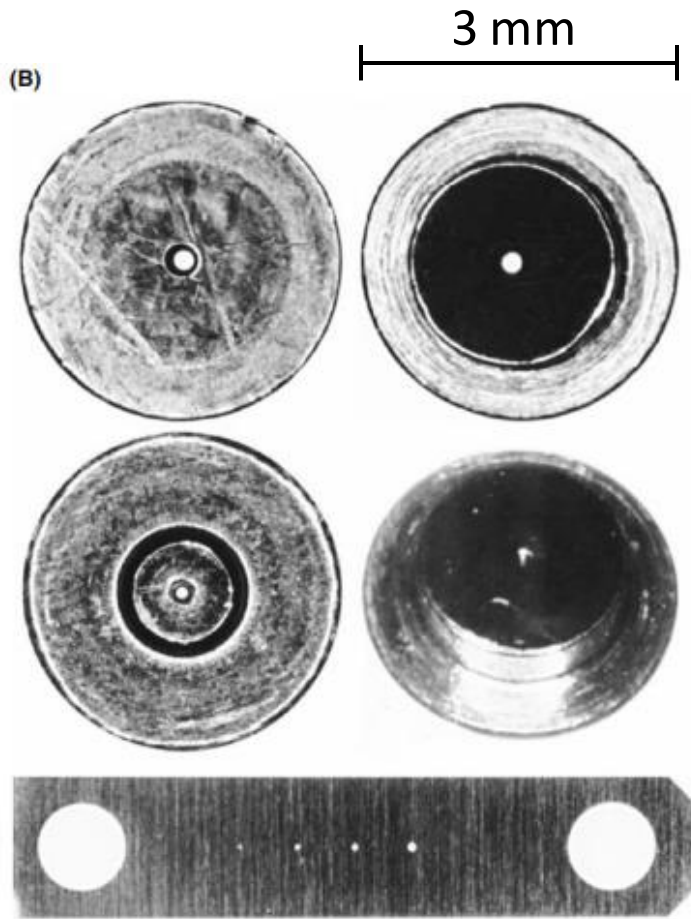

Condenser aperture
Objective aperture
Selective area aperture

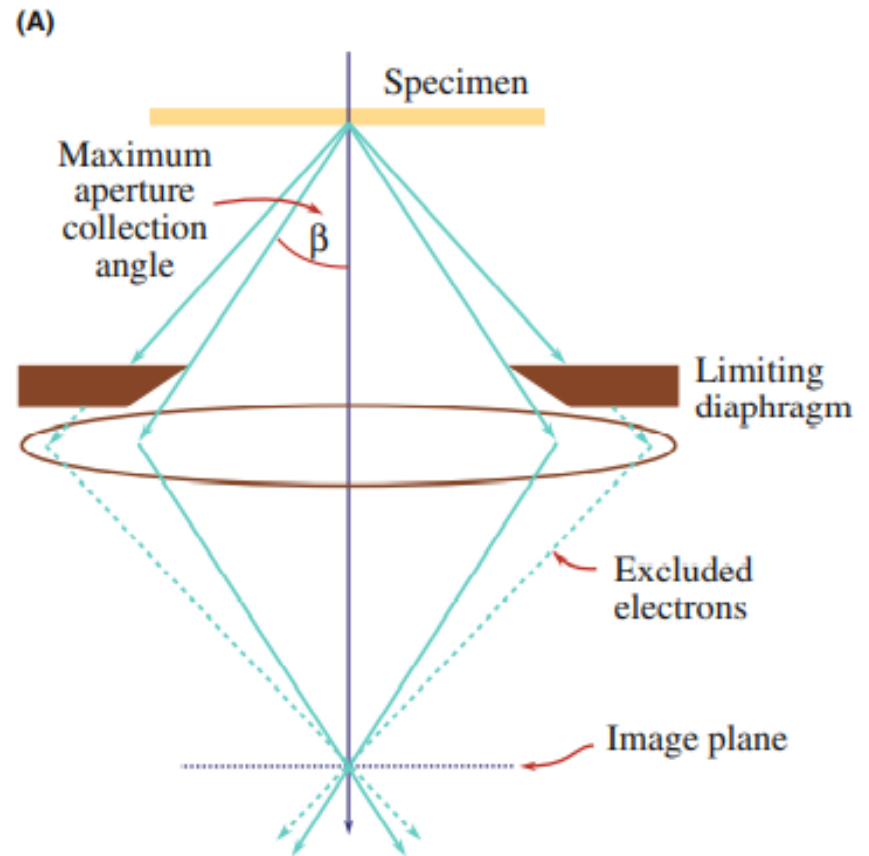

Controls beam intensity, parallity
Amplitude contrast
Diffraction imaging/dark field

What is happening when I operate the microscope?

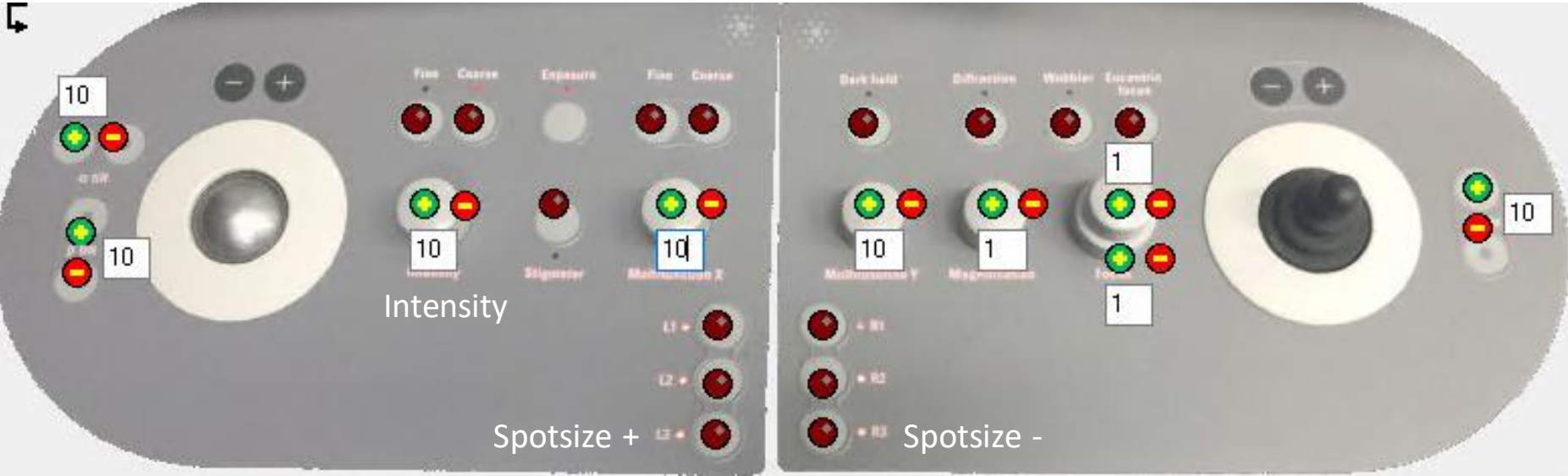

Condenser System

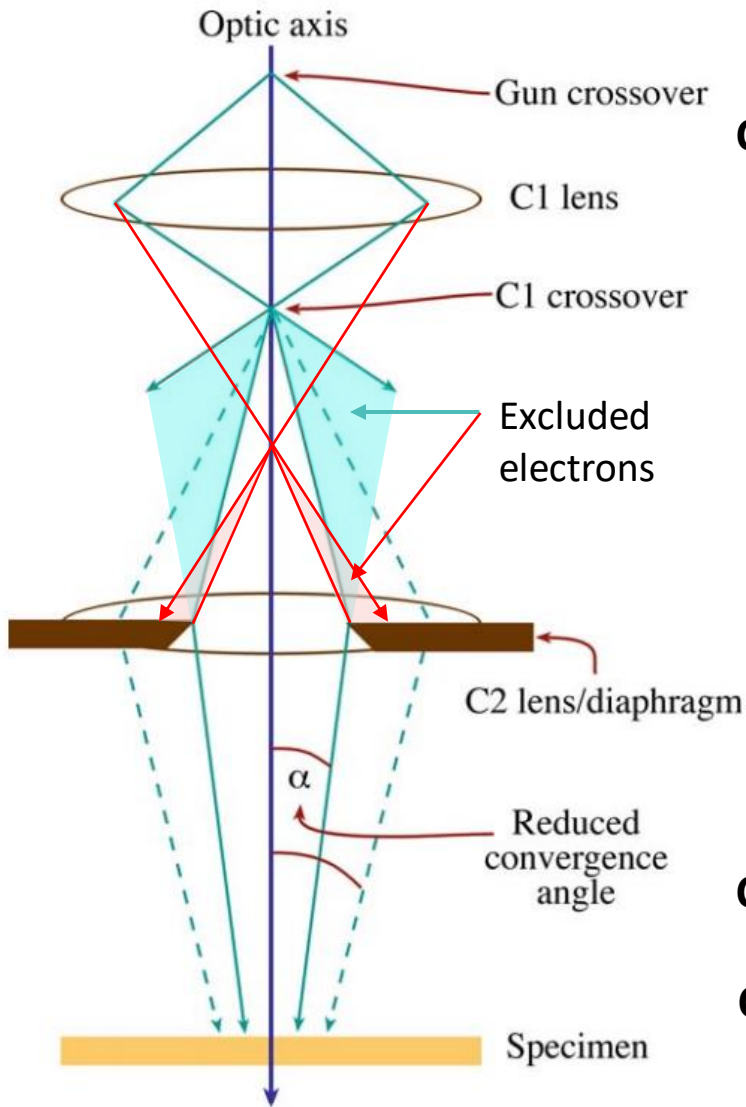

Gun tilt/shift: sets up beam to enter condenser system on optical axis

C1 = Spot size, controls beam size and quality

Spot 9: Strongest lens setting
Highest crossover
Dimmest beam and smallest focused beam
Most coherent little spatial divergence
Only most parallel electrons reach specimen

Spot 1: Weakest lens setting
Lowest crossover
Brightest & largest focus beam diameter
Least coherent
Greatest spatial divergence
Majority of electrons reach specimen

C2 aperture = limits amount of electrons reaching sample

C2 lens = Intensity knob. Controls diameter of beam reaching sample → (Dose/beam intensity)

Note on C2 Lens and Dose

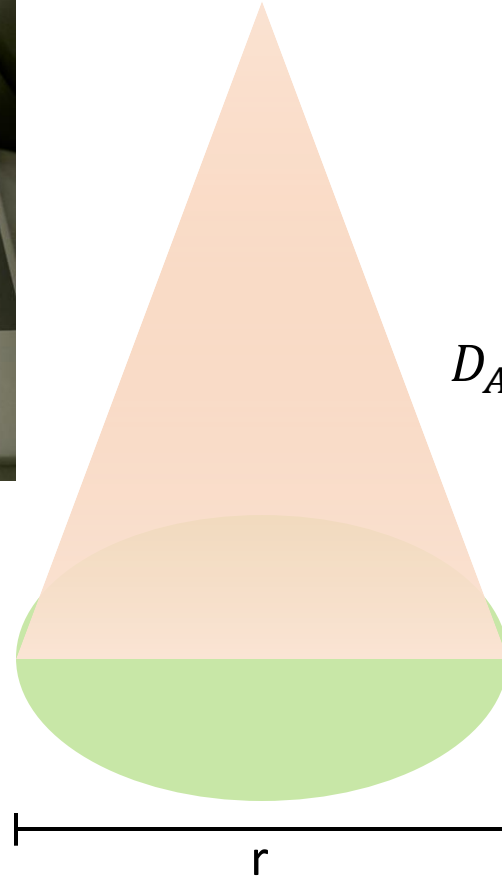

$$D_A = \frac{D_T}{A} = \frac{D_T}{\pi r^2}$$

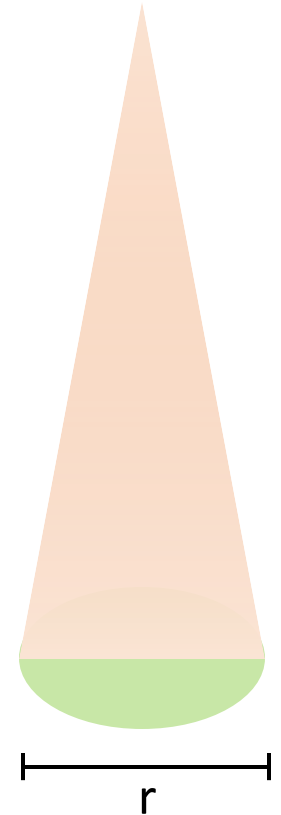

Dose in an area increase 4x when
you half the radius.

**USE THIS INTENSITY CONTROL
KNOB WISELY!**

DA = Dose per unit area
DT = Total dose In beam
A = Area
r = Beam Radius

C3 Lens (Krios)

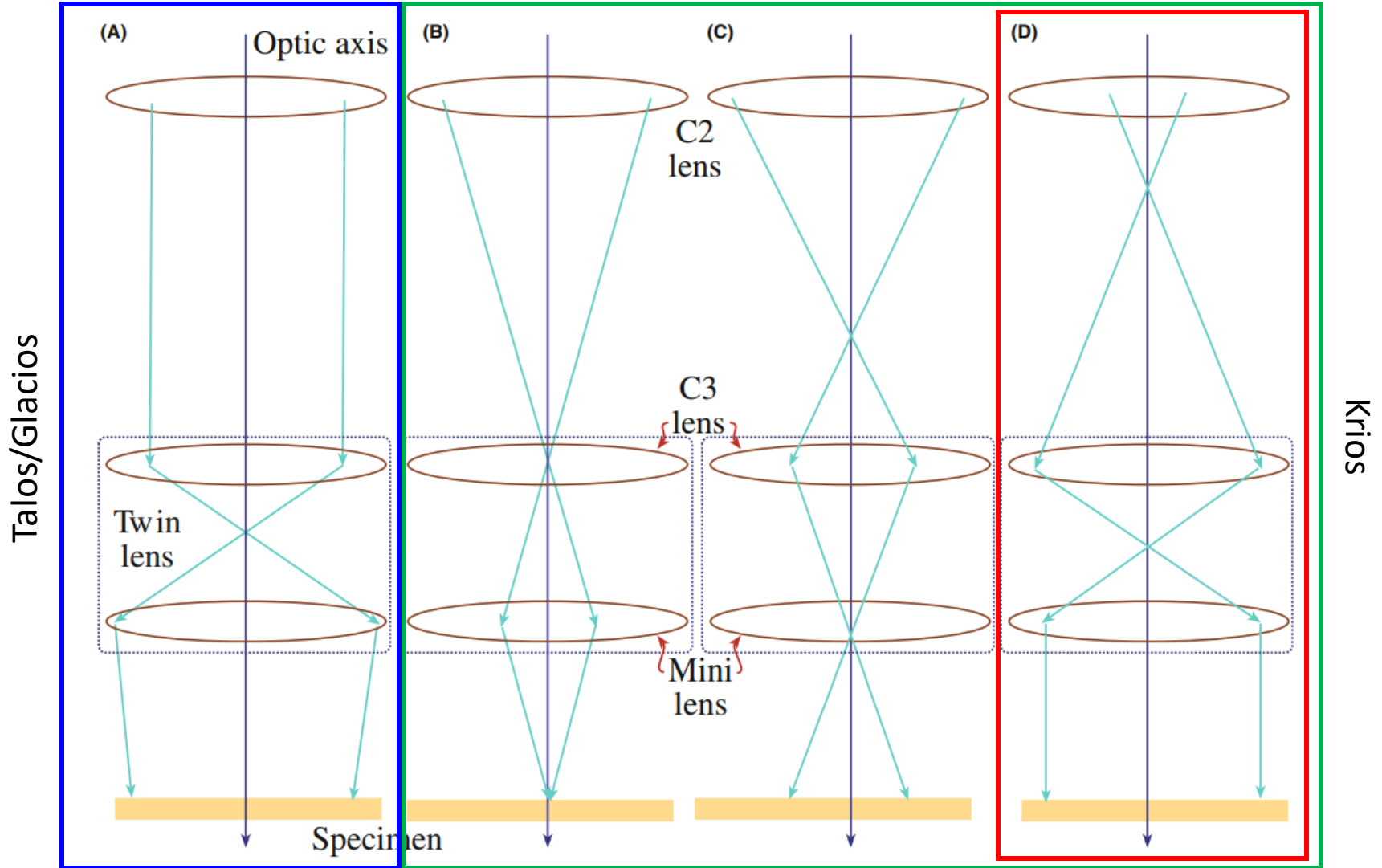

Parallel illumination of specimen reduces aberrations

C3 lens provides parallel illumination but only at certain C2 values

C3 Lens (Krios)

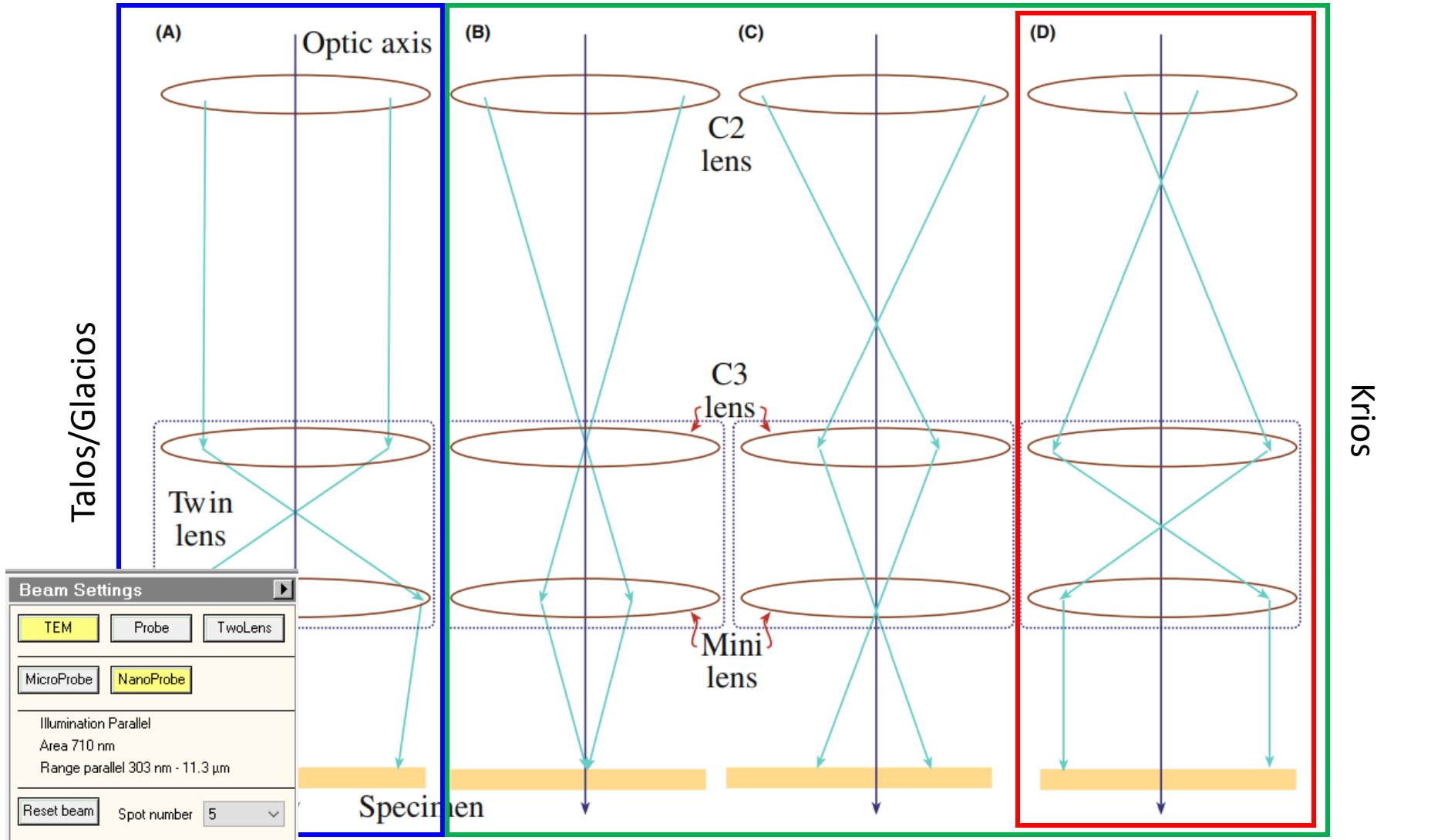

Beam Settings

Illumination Parallel
 Area 710 nm
 Range parallel 303 nm - 11.3 μm

Spot number

High tension:	300 kV	Unavail.	X:	-853.87 μm	C2 Lens:	40.687	
Screen current:	0.000 nA	Illuminated area:	710 nm	Y:	-290.48 μm	48.836	
Defocus:	909.97 nm	Spot size:	5	Z:	-34.50 μm	81.7245	
Focus step:	5			A:	-0.01 deg	Cooling BM-Falcon:	Stat
				B:	1.01 deg	Cooling BM-Ceta:	Unknow
				C1 Lens:	31.603 %		

Objective System

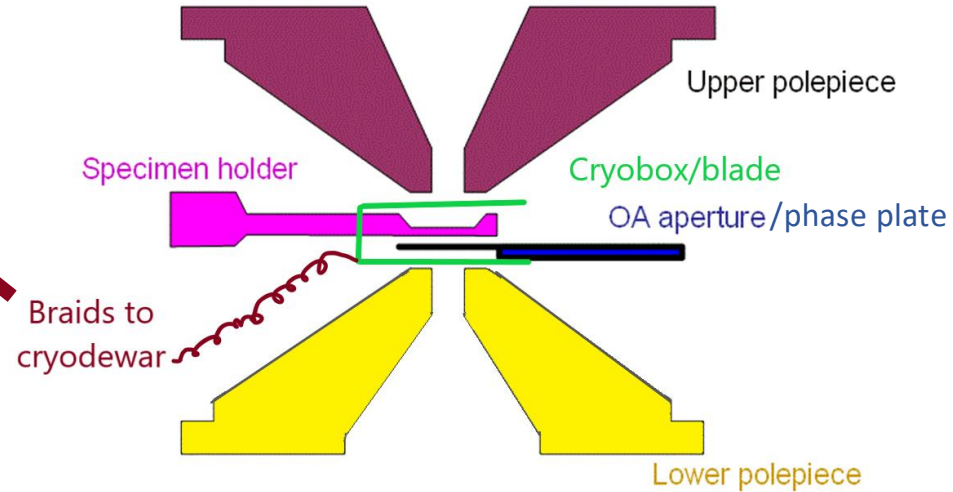
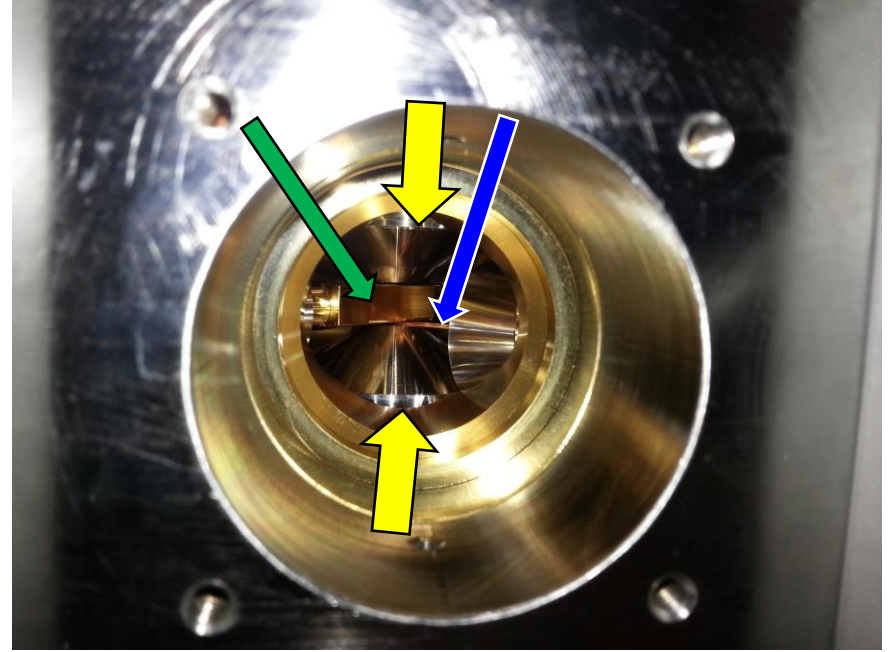
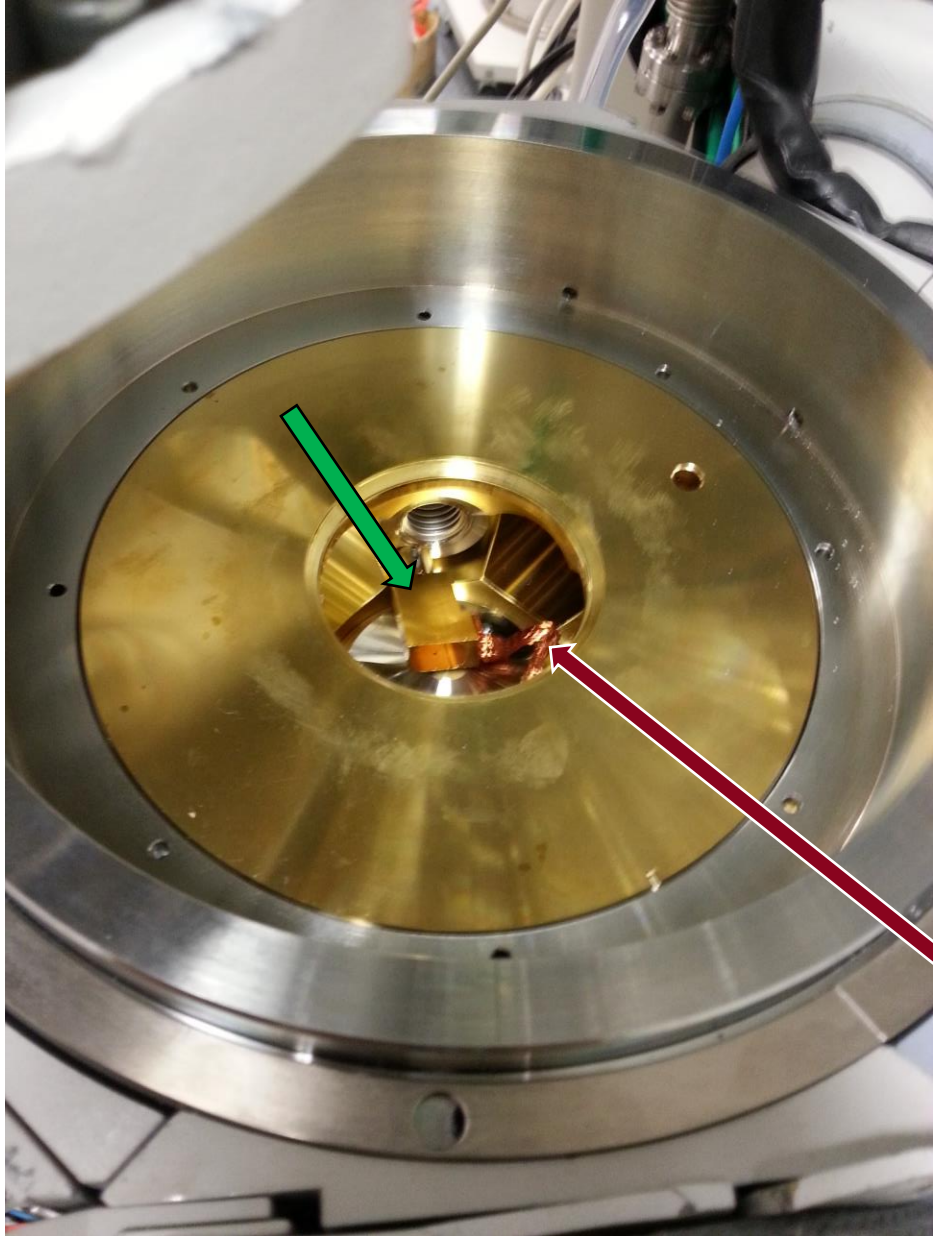

Objective System

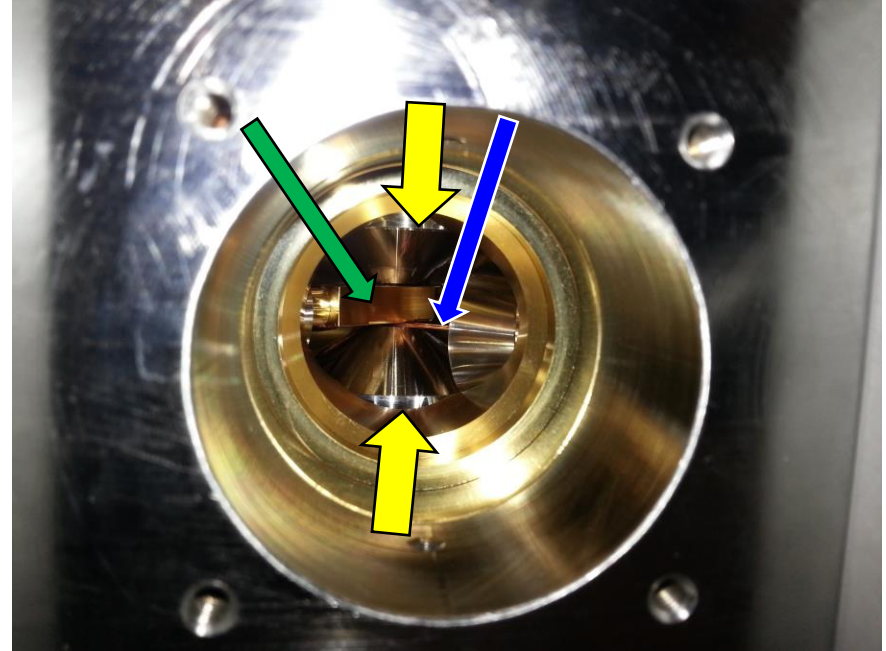
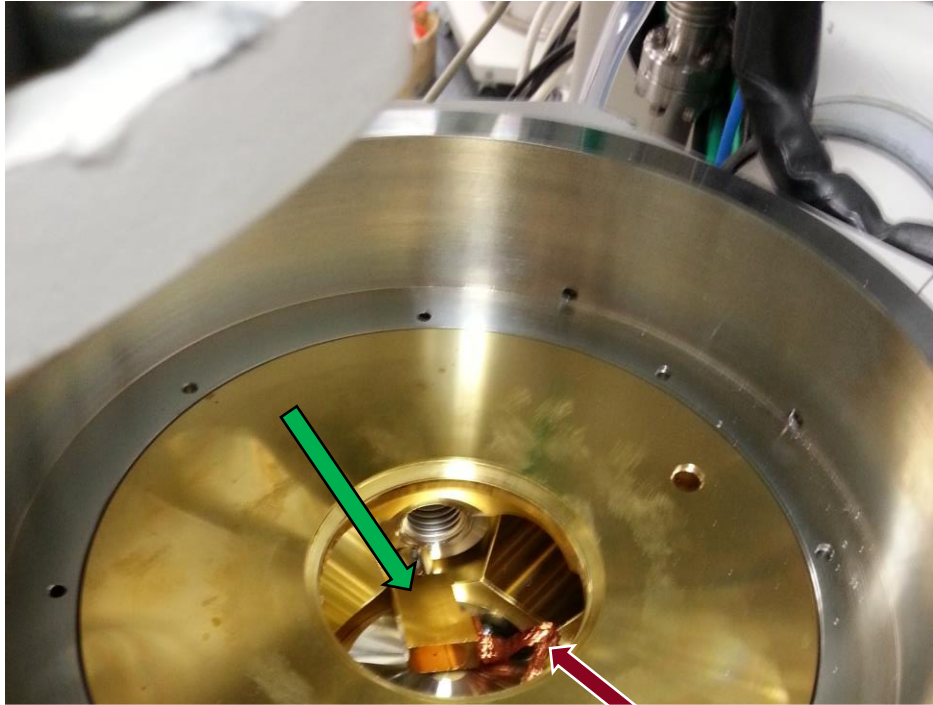

- Cryoblades cooled to LN₂ temp by braids
- Cryoblades colder than sample → cryotrap
- Keeps sample clean and cold by absorbing contaminant from sample/column
- Cryoblades needs to be warmed up regularly to remove contaminants → cryocycle
- Cryocycle: turns off IGP, pumps specimen chamber with Turbo

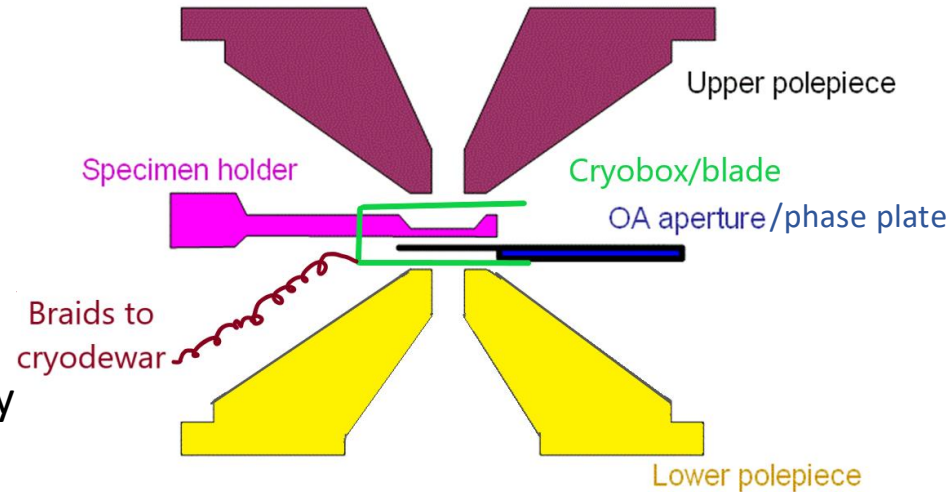

Gap between pole pieces is spherical aberration (Cs). Smaller gap = better.

Eucentric Height

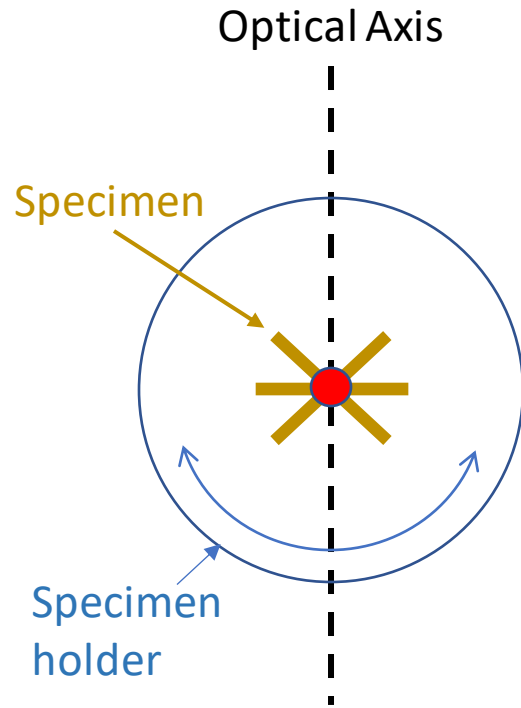

Excellent!

Tilt axis aligns on optical axis and eucentric focus
Specimen does not move when tilted

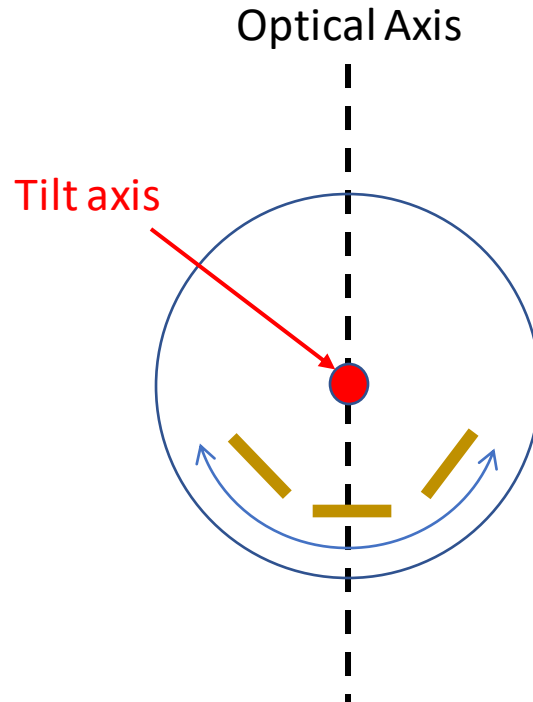

Bad

Specimen moves when tilted
Change specimen Z-height

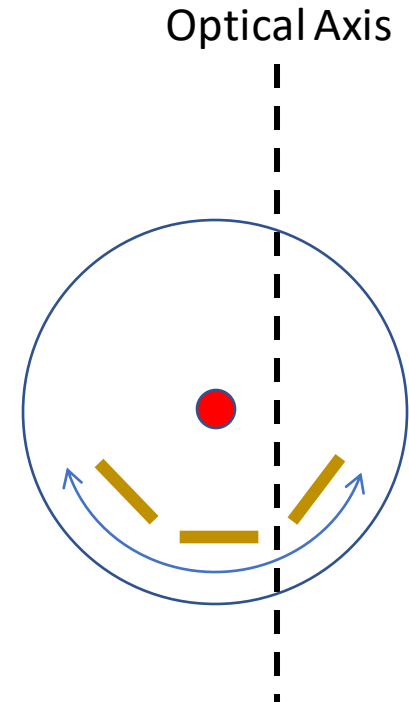

Very Bad

Specimen moves when tilted
Change specimen Z-height
Software or engineer required to align tilt axis with optical axis

Focus

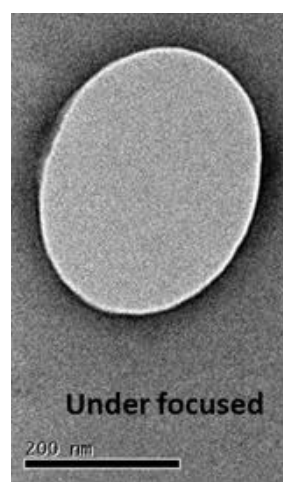
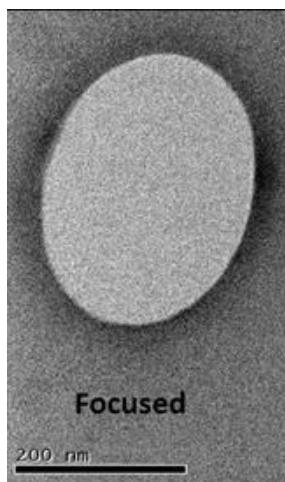
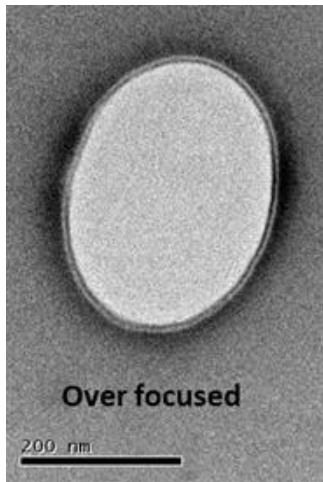
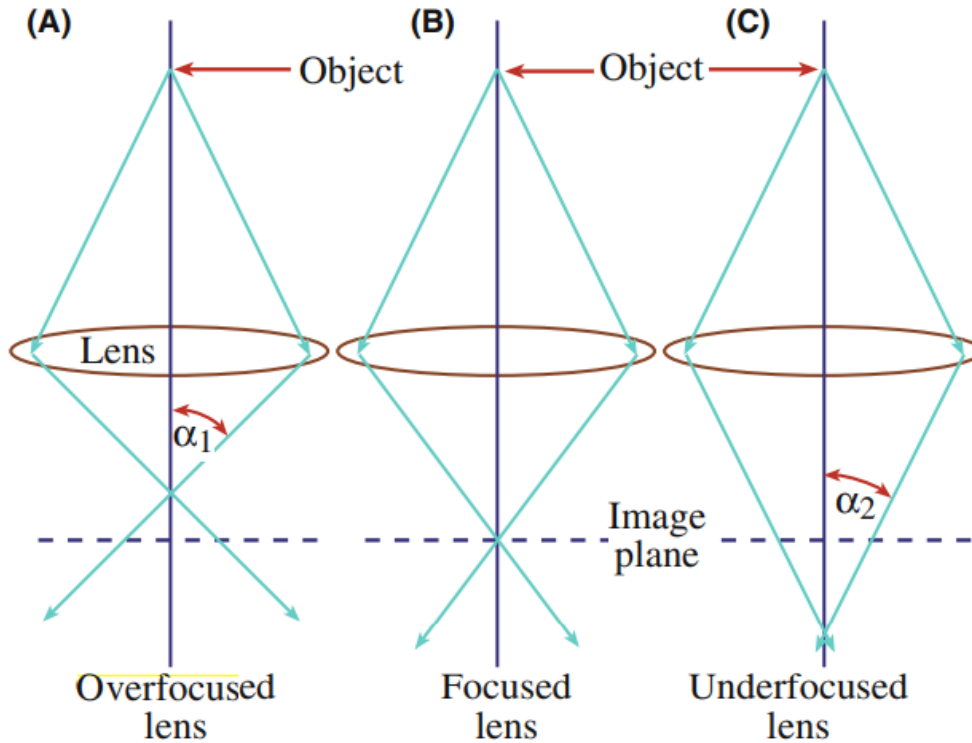

Modulating objective lens current changes clarity of image (focus)

If crossover above image plane - overfocused

If crossover below image plane - underfocused

Biological samples contain light atoms so minimal phase shifts occurs between scattered and unscattered rays

→ At focus, very little contrast

To see sample, either image underfocus or use phase plate

Phase Plates

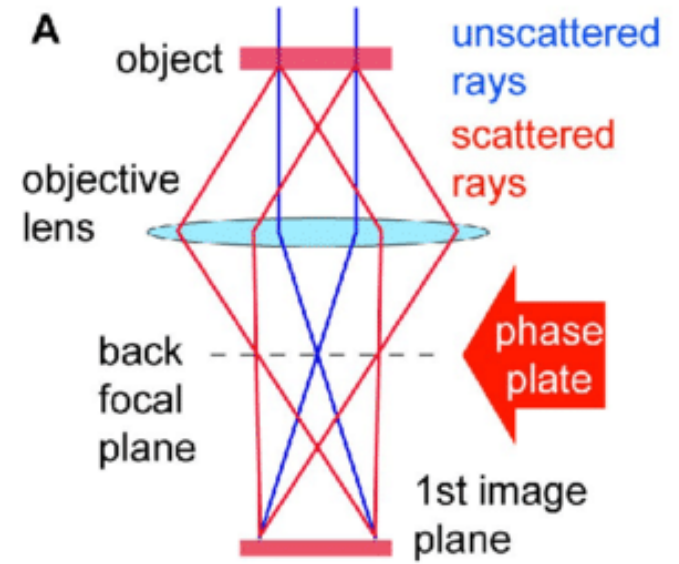
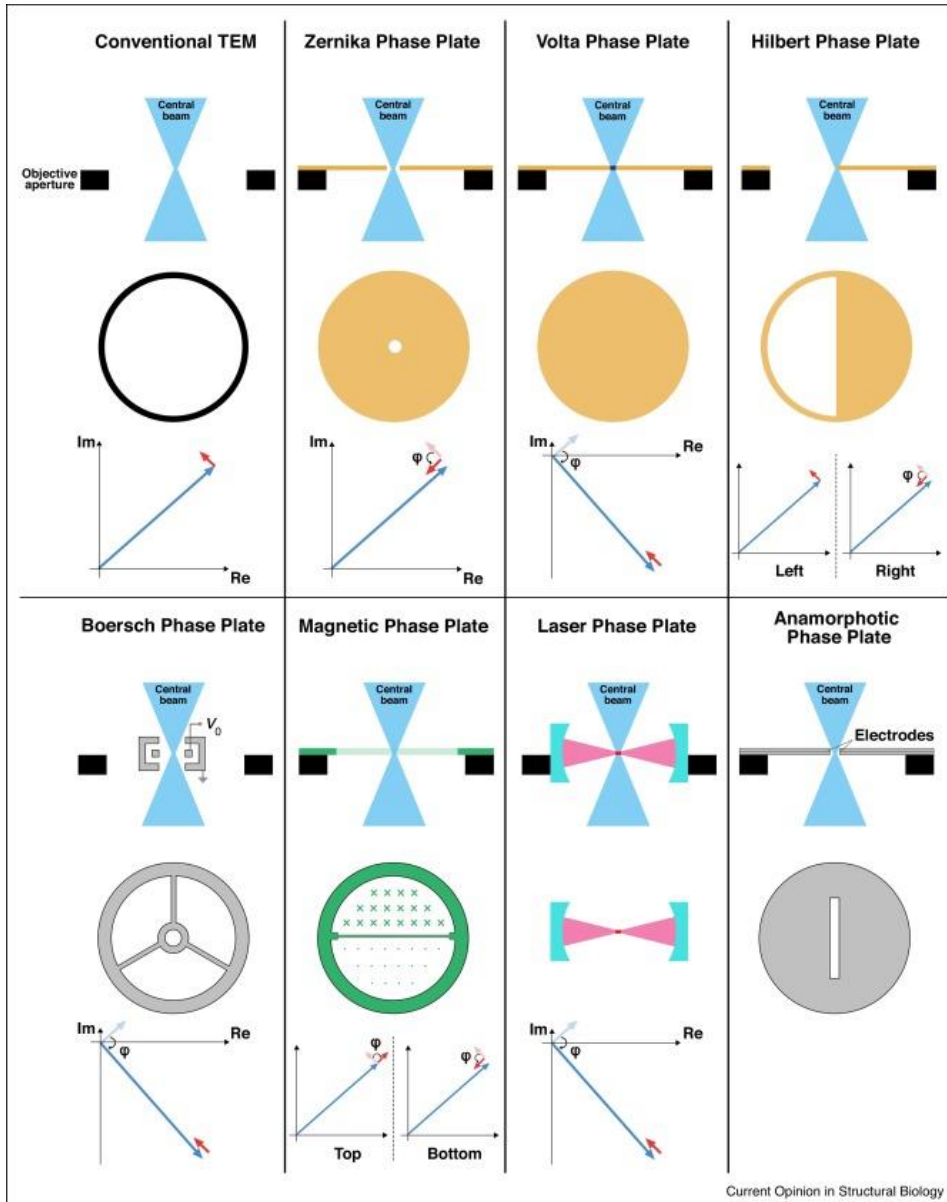

5 μ m defocus

At focus with VPP

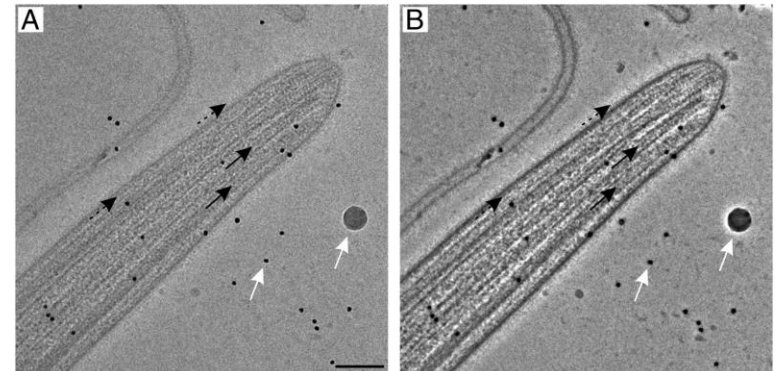

Projection System

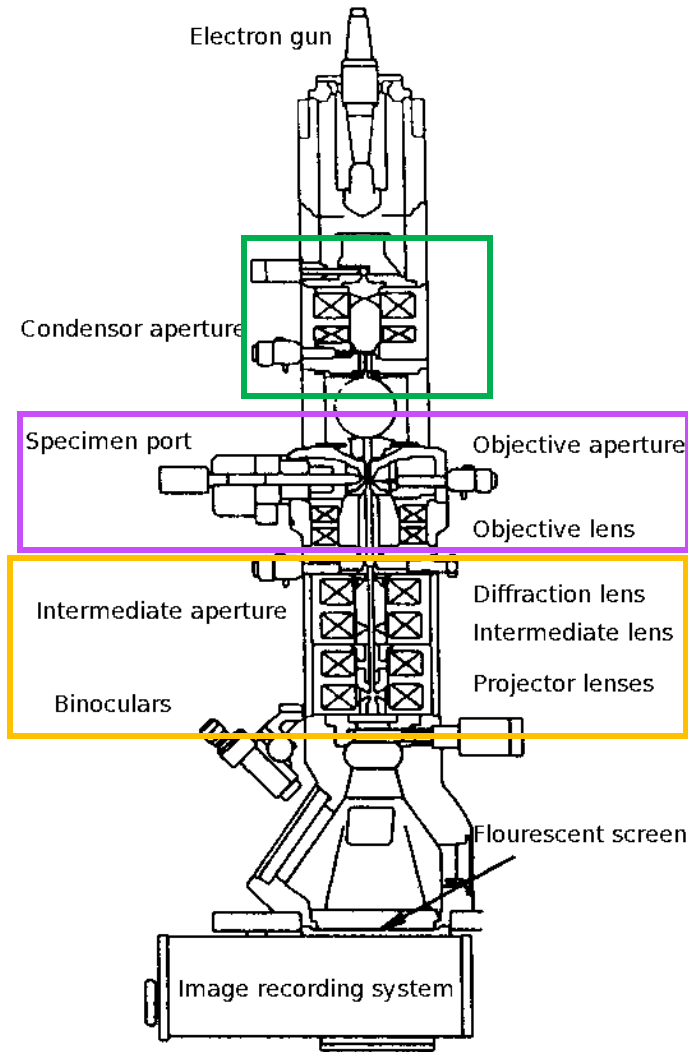

Condenser system

Objective system

Projector system

- Bunch of low strength lenses to increase magnification
- Tend to be ignored as aberrations outweighed by objective lens

Aberrations and Correctors

Magnetic lenses are poor quality and have severe aberrations:

Spherical aberration (position)

Chromatic aberration (wavelength)

Coma (angle of entry)

Stigmatism – defects in magnetic field symmetry

Spherical Aberration (Cs)

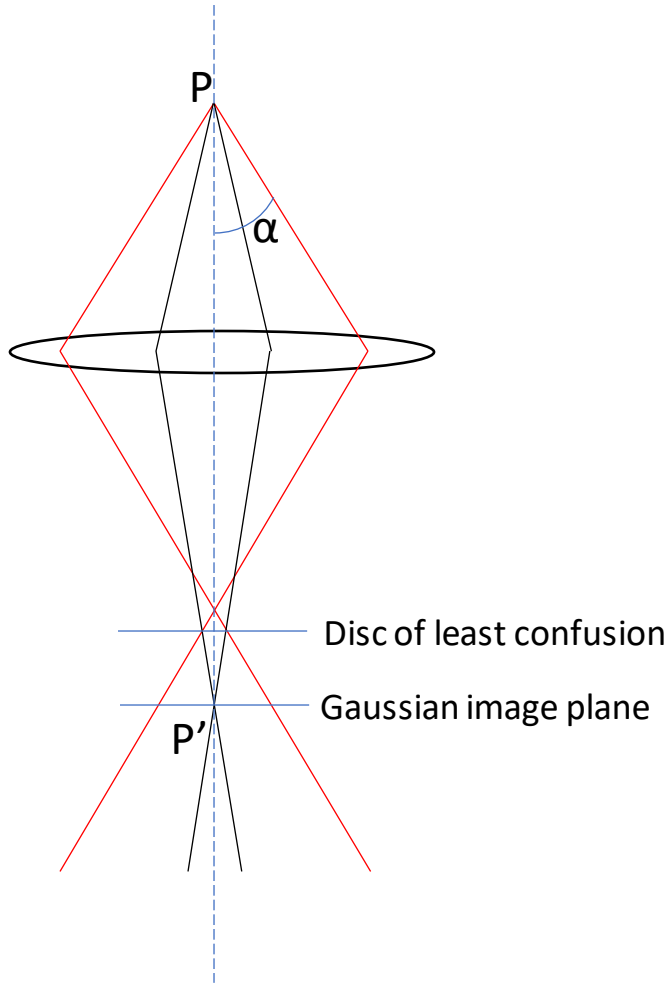

- Lenses are strongest at edge
- Thus off-axis electrons bent more than on-axis
- Different focus points

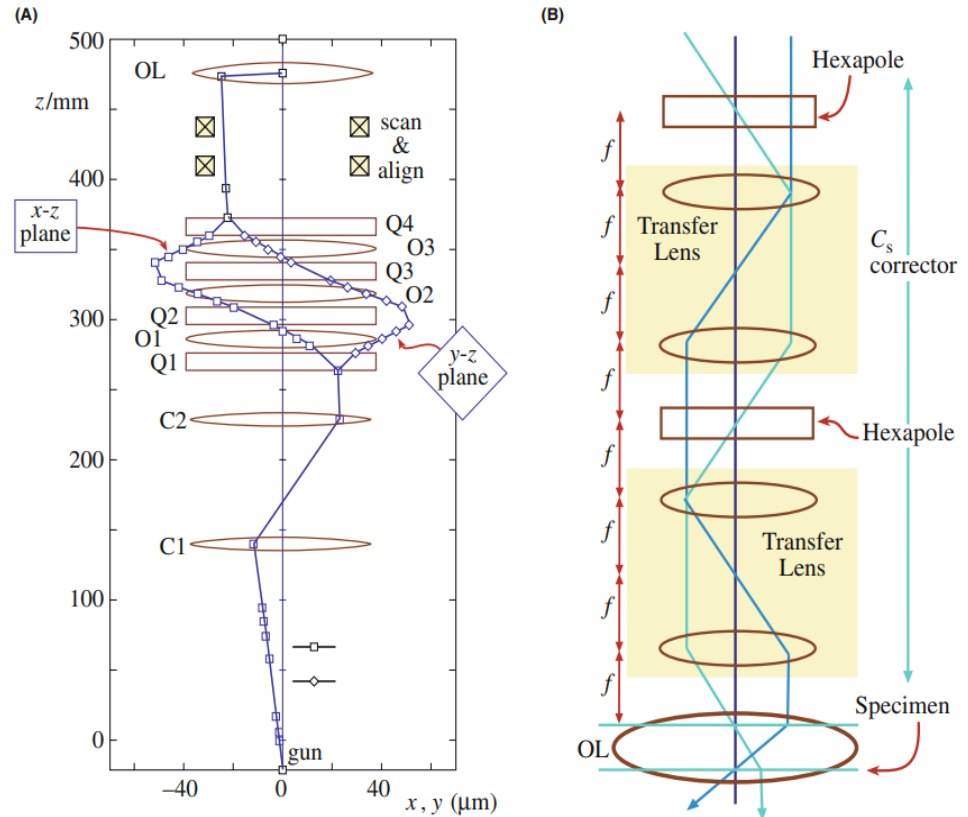
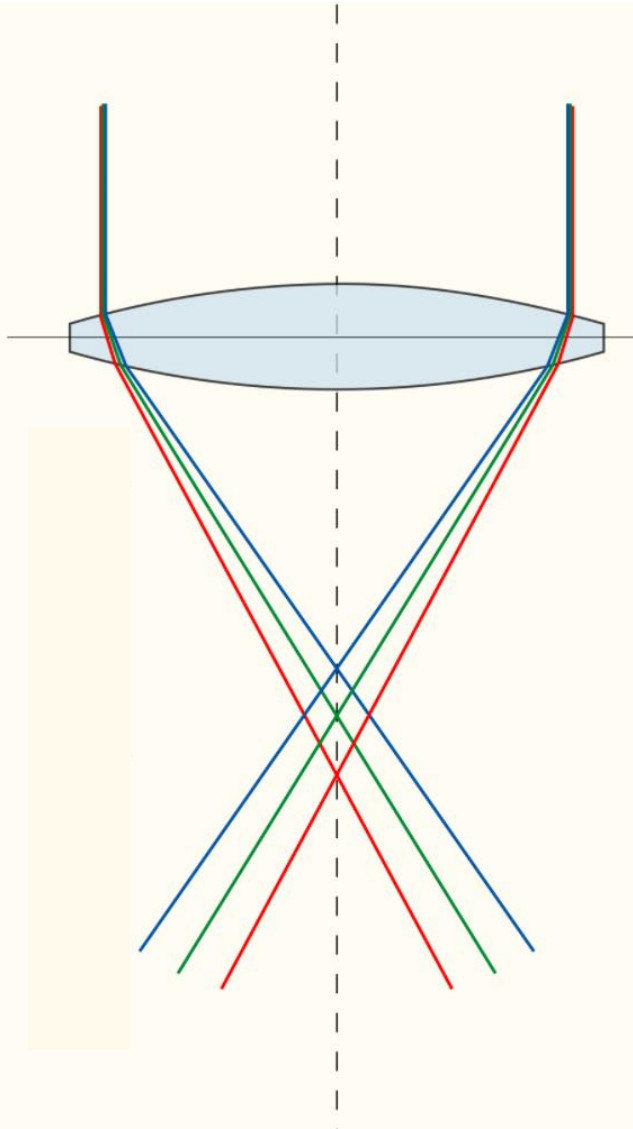

FIGURE 6.12. Ray diagrams showing how the two different commercial systems use (A) multiple quadrupole (Q) and octupole (O) lenses (Nion) or (B) hexapole and other transfer lenses (CEOS) to correct for C_s .

To reduce C_s :

- Increase lens strength
- Decrease pole gap
- Install C_s corrector (important for imaging $< 0.5 \text{ \AA}$)

Chromatic Aberration (Cc)



Electrons of different wavelengths are focused at different point

Cause of wavelength variation:

- Electron source

- Interaction with sample

 - (especially thick samples)

Correct using:

- FEG instead of Tungsten

- Monochromator after gun

- Energy filter after sample imaging

(Important for thick samples)

Energy Filter

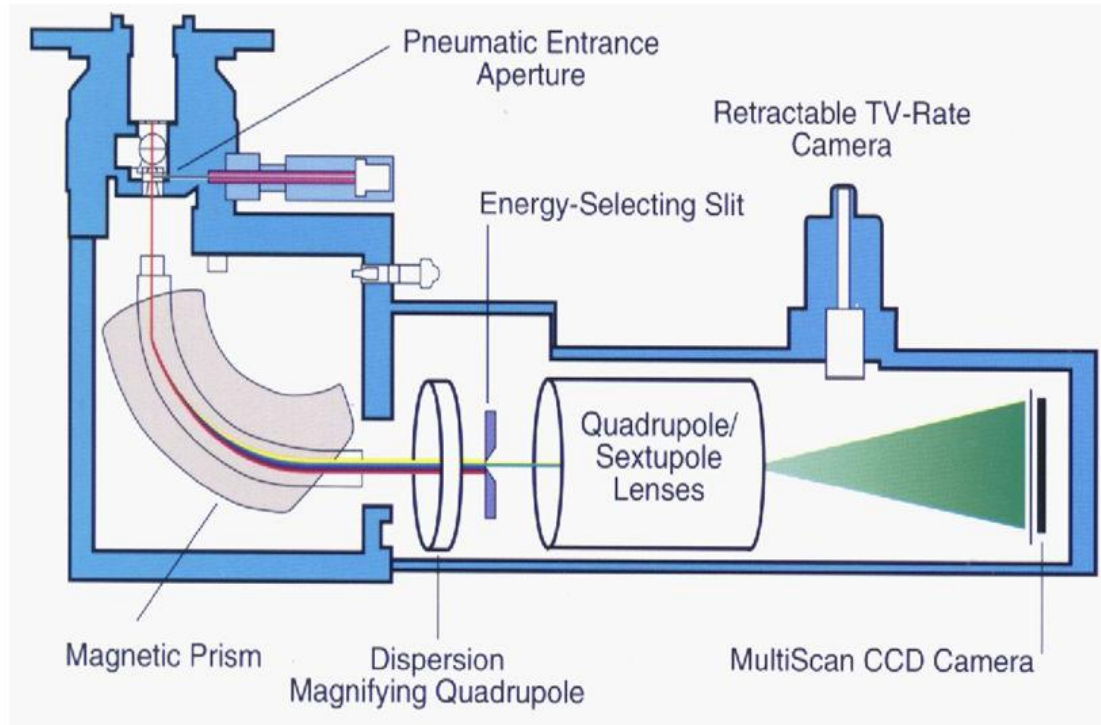

Unfiltered

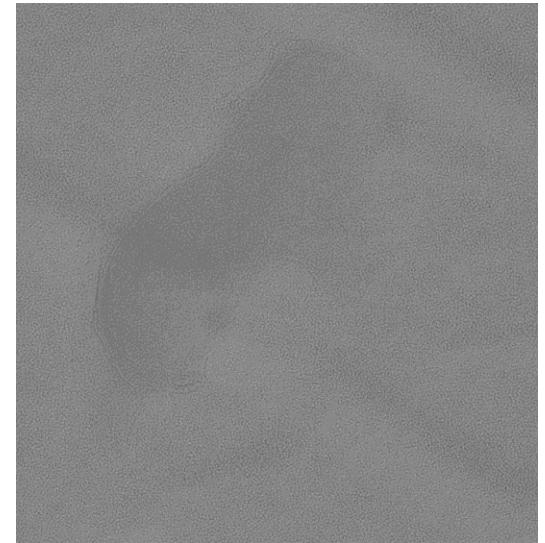

20eV Energy Filter

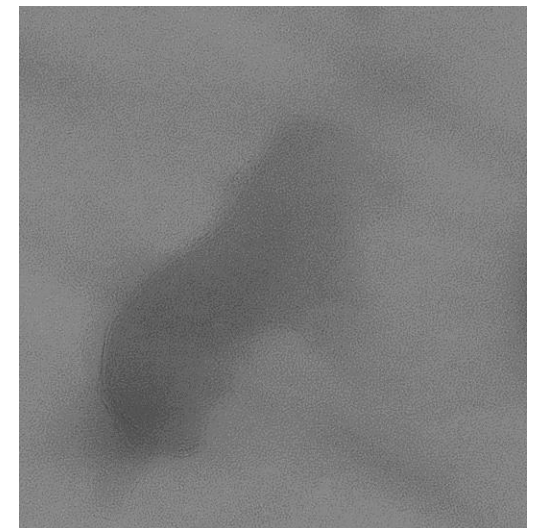

- Elaborate mass spec
- Select for specific wavelength
- Zero-loss imaging (elastically scattered waves)
- EELS – Selects wavelength of inelastically scattered rays – chemical composition

Coma

- Beam enters lens at angle
- Cs causes rays to bend depending on location
- Point source becomes comet shaped
- To correct: Apply +/- beam tilt
- FFT of opposite beam tilts should be identical

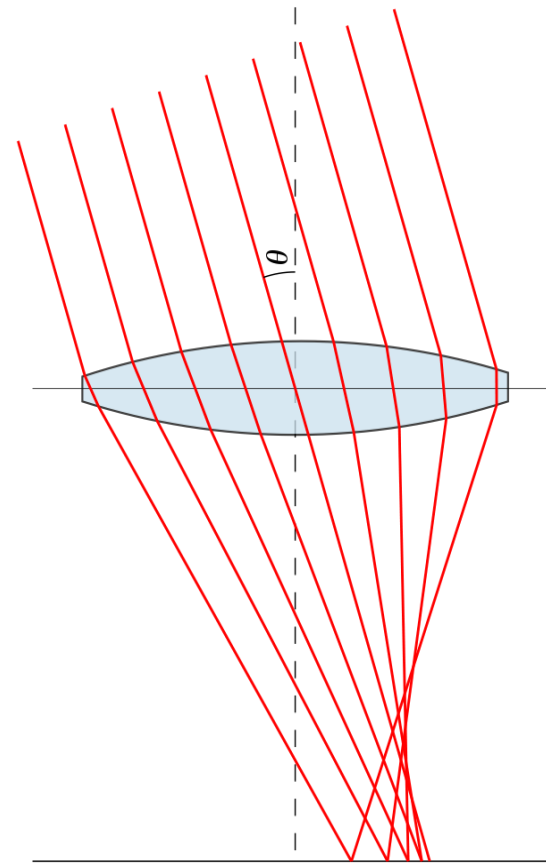
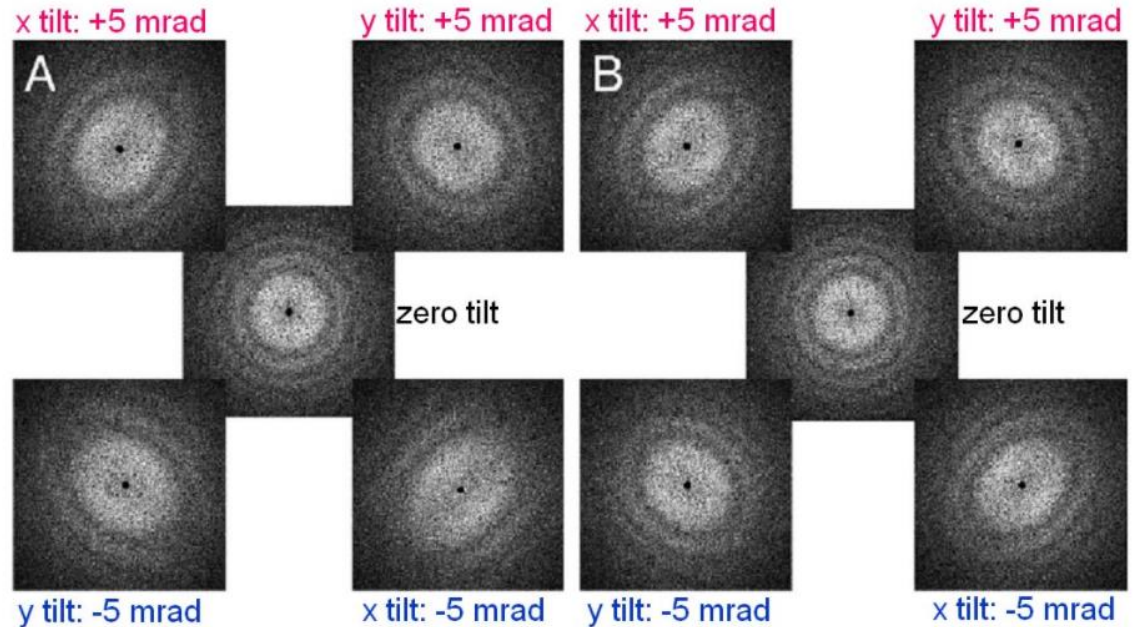
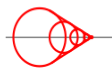

Image of point
looks like a comet



(Important to obtain resolutions beyond 5 Å)

Detection System

Fluorescent Screen



Charge coupled device (CCD)

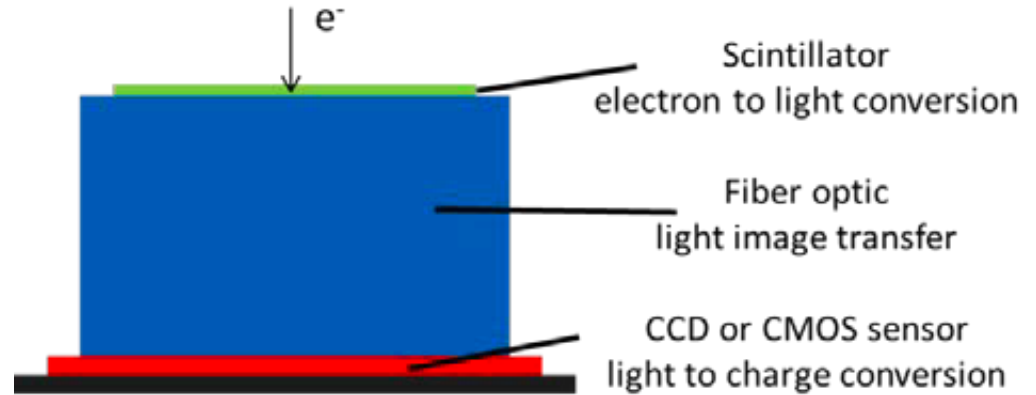

Film + Scanner



Direct Electron Detectors (DEDs)

(e.g. K3/Falcon)

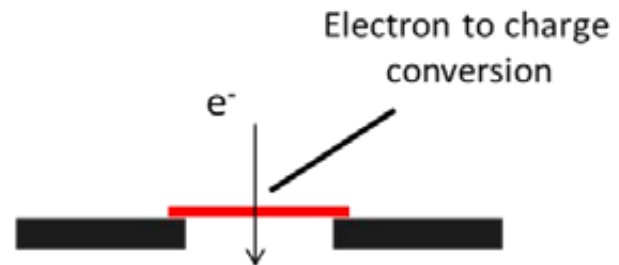

Camera Quality Measurement

Modular transfer function
(MTF)



How fast does intensity change at sharp edge?

Fast change, great camera, able to capture high resolution data

Slow change, poor camera, resolution limiting

Detection Quantum Efficiency
(DQE)

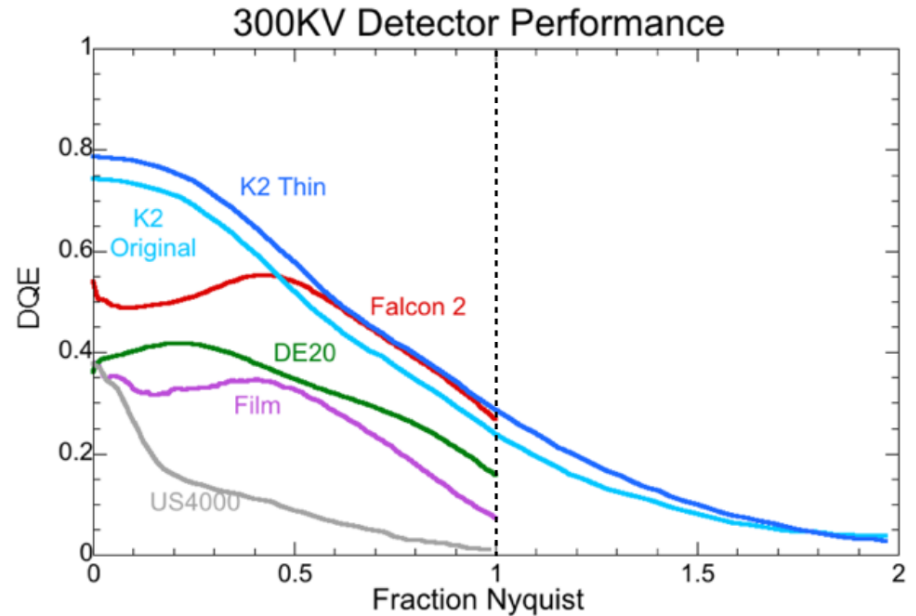

$$DQE = \frac{SN_{out}^2}{SN_{in}^2}$$

DQE = 1, excellent camera, no loss of signal
Nyquist = $1/2px$

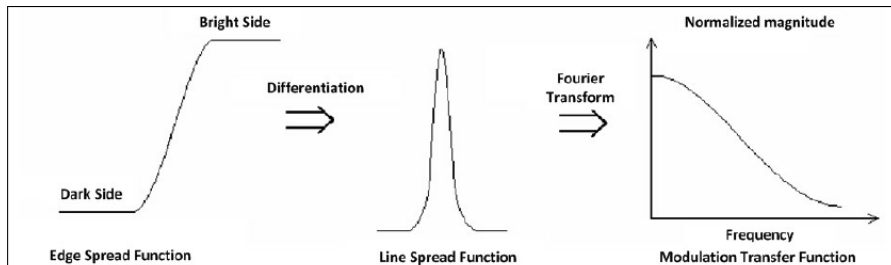
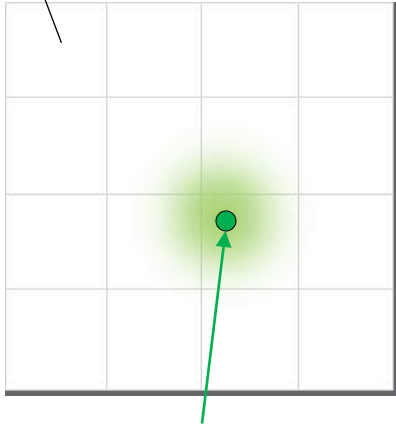

Figure 3. Computation of the Modulation Transfer Function using the knife-edge target.

Integrated vs Counted (super-resolution) Mode

Pixel



Incoming Electron

Electron hits pixel array and causes charge spread

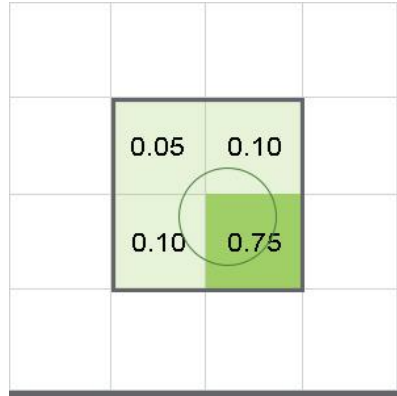

Integration mode

Integrating mode reads out accumulated charge in each pixel

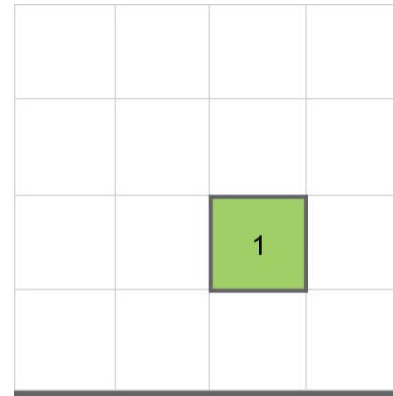

Counting mode

Assumes $1e^-$ in, $1e^-$ out. Calculates most probably location of electron hit.

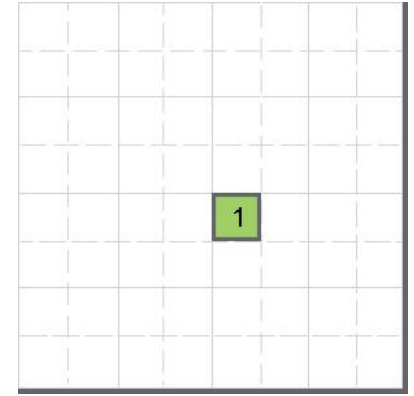

Super-resolution

Subdivides pixel to give more accurate location of electron hit.

Nyquist: maximum resolution of detector ($2 \times$ px size)
represented by sine wave where 1px white, next black (smallest sampling frequency)

Suggested Reading

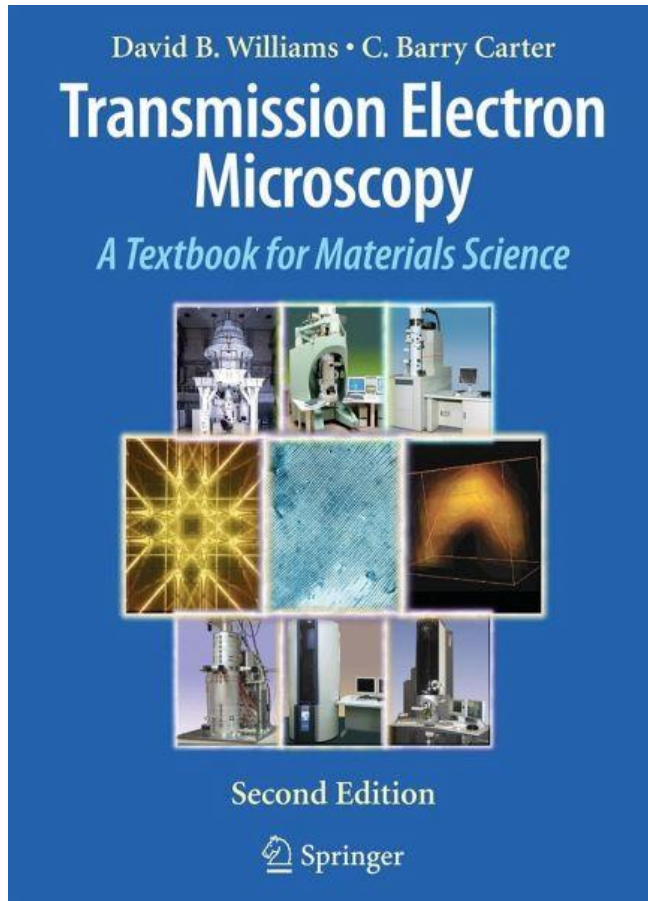

http://myscope.training/#/TEMlevel_2_4

Flash of TEM:

<http://www.doitpoms.ac.uk/tlplib/tem/illumination.php>

<http://cryo-em-course.caltech.edu/overview>

Youtube

[1.7. Electron Optics — Introduction to Transmisison Electron Microscopy \(gduscher.github.io\)](https://github.com/gduscher)

An introduction to electron optics

The microscope consists essentially of three parts:

1. The **electron gun** where the beam is generated.
2. The **lenses, deflection coils** and **stigmators** that make the image and project it on the screen.
3. The projection chamber with one or more types of **electron detectors** to record images, diffraction patterns, ... (plate camera, TV, ...).

The first two topics will be covered in this section.

Electron gun

The electron beam is generated in the electron gun. Two basic types of gun can be distinguished: the thermionic gun and the field emission gun (FEG).

Thermionic guns are based on two types of filaments: tungsten (W) and lanthanum-hexaboride (LaB₆) (cerium-hexaboride, CeB₆, can also be used instead of LaB₆; its performance is roughly the same as that of LaB₆). On modern instruments the different types of thermionic filaments can be used interchangeably.

The **FEG** employs either a (thermally-assisted) cold field emitter - as on the Philips EM 400-FEG - or a Schottky emitter - as on the more recent generations of FEG microscopes (CM20/CM200 FEG, CM30/CM300 FEG, Tecnai F20 and F30).

Electron optics elements

Electron optics elements in the microscope column fall into three different categories: lenses, deflection coils and stigmators.

Lenses are the most important. They provide us with the means to (de)focus the electron beam on the specimen (the condenser system), focus the image (the objective lens), change the magnification and switch between image and diffraction (the magnification system).

Deflection coils allow us to shift or tilt the beam. In most cases this is used to correct for mechanical misalignments of the column. There are also other cases where the deflection coils are used to obtain a specific effect, such as tilting the beam in dark field or shifting the beam in STEM.

Stigmators are elements that allow us to correct for deficiencies in the electron lenses. In principle lenses are round and perfectly symmetrical. In practice there are small deviations from perfection which are corrected with the stigmators.

Thermionic gun

The thermionic gun (so-called triode or self-biasing gun) consists of three elements: the filament (cathode), the Wehnelt and the anode. The Wehnelt has a potential that is more negative - the bias voltage - than the cathode itself. The bias voltage is variable (controlled by the Emission parameter) and is used for controlling the emission from the filament. A high bias voltage restricts the emission to a small area, thereby reducing the total emitted current, while lowering the bias voltage increases the size of the emitting area and thus the total emission current.

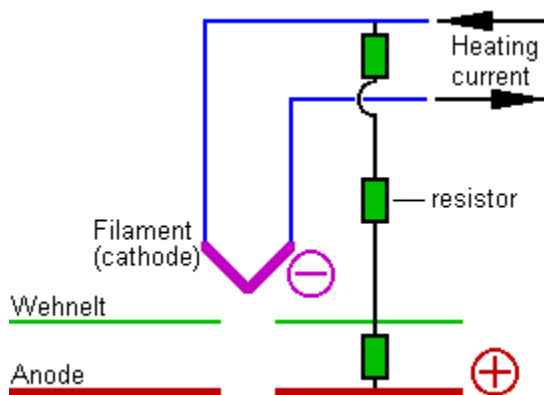

The emitted electrons that pass through the Wehnelt aperture are focused into a cross-over between the cathode and anode. This cross-over acts as the electron source for the optics of the microscope.

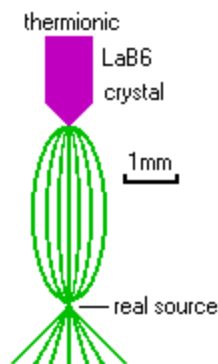

The size of the cross-over is determined by the type of filament, the electric field between cathode and anode, and by the exit angles of the electrons from the filament. At low bias voltages, electrons are emitted from a larger area of the curved tip of the filament, causing a higher divergence of emission angles and thus a larger source size. Higher emission therefore not necessarily improves the brightness (a performance parameter of the emitter, measured in A/cm^2srad). In addition, higher emission increases the Coulomb

interaction between electrons - the so-called Boersch effect - (some get accelerated, others decelerated) which increases the energy spread.

Field Emission Gun

In the case of a Field Emission Gun (abbreviated FEG), electron emission is achieved in a different way than with thermionic guns. Because a FEG requires a different gun design as well as much better vacuum in the gun area ($\sim 10^{-8}$ Pa instead of the $\sim 10^{-5}$ Pa necessary for thermionic guns), it is found only on dedicated microscopes (Tecnai F20, F30). The FEG consists of a small single-crystal tungsten needle that is put in a strong extraction voltage (2-5 kV). In the case of a cold FEG or thermally-assisted cold FEG, the needle is so sharp that electrons are extracted directly from the tip. For the Schottky FEG (as used on the Tecnai microscopes) a broader tip is used which has a surface layer of zirconia (ZrO_2). The zirconia lowers the work function of the tungsten (that is, it enhances electron emission) and thereby makes it possible to use the broader tip. Unlike the thermionic gun, the FEG does not produce a small cross-over directly below the emitter, but the electron trajectories seemingly originate inside the tip itself, forming a virtual source of electrons for the microscope.

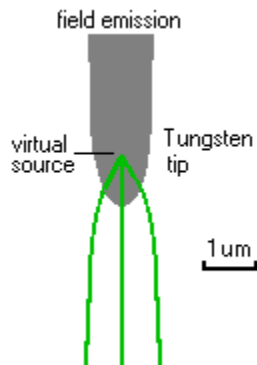

The FEG emitter is placed in a cap (suppressor) which prevents electron emission from the shaft of the emitter and the heating filament (very similar to the Wehnelt of the thermionic gun). Electron emission is regulated by the voltage on the extraction anode. Underneath the extraction anode of the FEG is a small electrostatic lens, the gun lens. This lens is used to position the first cross-over after the gun in relation to the beam-defining aperture (usually the C2 aperture). If the gun lens is strong, the cross-over lies high above the aperture while a weak gun lens positions the cross-over close to the aperture, giving a high current but at the expense of aberrations on the beam. A strong gun lens is therefore used where small, intense and low-aberration electron probes are needed (diffraction, analysis and scanning), while a weak gun lens is used when high currents are important (TEM imaging). In the latter case, the beam is spread and the aberrations do not affect the area within the field of view.

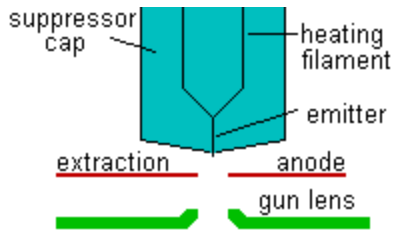

The high brightness of FEGs comes about because of two reasons:

1. The small size of the tip ensures that large numbers of electrons are emitted from a small area (high A/cm²).
2. The electrons come out of the tungsten crystal with a very restricted range of emission angles (high A/srad).

FEGs also have a low energy spread due to their low working temperature and emission geometry (small virtual source size, but much larger actual size of the emitting area).

Lenses

The lenses in electron microscopes are electromagnetic lenses (the only exception being the gun lens in the FEG instruments, which is an electrostatic lens). These lenses all consist of a coil, through which an electrical current flows, and a magnetic circuit, which is a piece of magnetic alloy with a specific shape. The current flowing through the coil generates a magnetic field in the magnetic circuit. Where the circuit is interrupted (the gap), the magnetic field goes out into the vacuum and creates the lens field that is used for focusing the electron beam. How the lens works is determined by the shape of the pole piece (the part of the magnetic circuit where the bore and gap are). Water flows through pipes to remove the heat generated by the electron current in the lens coil.

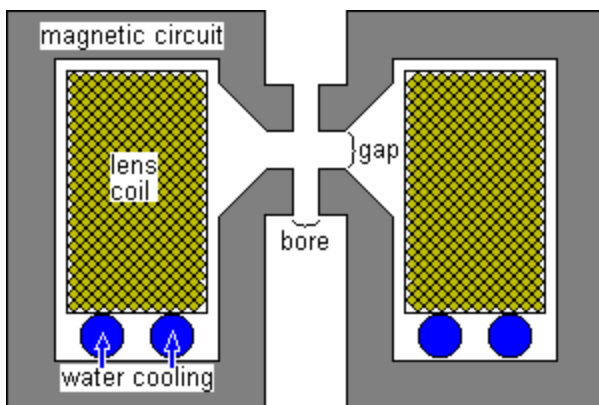

Changing the current through the lens coil changes the magnetic field and thus the strength of the lens. Although electromagnetic lenses and electrons behave quite

differently from light lenses and light, the general principles of light optics can be applied and the electromagnetic lenses can be described for convenience like the lenses of light optics.

The TEM usually contains two condenser lenses:

- The first condenser lens, or C1, determines the demagnification (size reduction) of the electron source onto the specimen and thus the spot size. Its control is found under the spot size control, which has 11 steps.
- The second condenser lens, or C2, determines how strongly the beam is focused onto the specimen. As a consequence it varies the intensity of the beam on the viewing screen. The C2 lens is controlled through the Intensity knob. Inside or close to the second condenser lens there is an aperture (the second-condenser or C2 aperture), which is used as the beam-defining aperture (it limits the amount of the beam convergence for a fully focused beam).

The magnification system of the microscope consists of a set of five lenses: the objective, diffraction, intermediate, projector 1 and projector 2 lenses. Except in low-magnification (LM) mode, the objective lens is always the strongest lens in the microscope, magnifying between about 20 and 50x, depending on the type of objective lens.

The individual lenses of the magnification (or projector) system are not controlled directly by the operator, but instead the microscope contains a number of magnifications for image and diffraction mode, each with its own settings of the magnifying lenses. The only lenses that are controlled directly by the operator are the objective lens (for focusing the image) and the diffraction lens (for focusing the diffraction pattern).

In LM mode the objective lens is switched (nearly) off in order to achieve the smallest magnifications. With the objective lens off, the diffraction lens is used for focusing the image. The electron-optical configuration in LM is reversed with respect to the high-magnification range: the functions of the objective and diffraction lenses and stigmators switch as do the functions of the objective and selected-area apertures.

Lens and aperture functions in HM (objective lens on) and LM (objective lens off)

	High Magn	Low Magn
Obj. lens	Image focus	Diffraction (LAD) focus
Diff. lens	Diffraction focus	Image focus
Obj. aperture	Contrast forming	Area selection
SA aperture	Area selection	Contrast forming
Obj. stigmator	Image stigmation	Diffraction stigmation
Diff. stigmator	Diffraction stigmation	Image stigmation

TWIN-type objective lenses

Most Tecnai microscopes are equipped with a [TWIN-type objective lens](#) (the variants BioTWIN, TWIN, S-TWIN and U-TWIN). The lens design and the two resulting basic optical modes, the microprobe and nanoprobe modes, are discussed separately in more detail.

Deflection coils

Throughout the microscope, the path followed by the electron beam is affected by a number of deflection coils, mounted in different locations. Deflection coils play an essential role in the alignment of the microscope and are used for aligning the gun, beam, objective lens, magnification system (image and diffraction shifts to the screen center) and detector alignments (image or diffraction shifts to a detector that is situated off the optical axis). Most of the steps in the alignment procedures either align the deflection coils themselves or use the deflection coils to align another electron-optical element.

In principle a single deflection coil is sufficient for a particular action, provided that it is mounted at the level where its action is needed. In practice, such arrangements are not feasible due to space limitations or other constraints. All deflections are done therefore through double deflection coils that are situated at another level in the microscope.

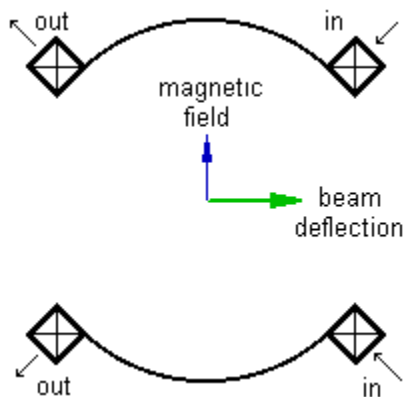

A deflection coil is a set of coils on either side of the electron beam. If one is given a positive magnetic field and the other one a negative one, the electrons in the beam will be attracted by the positive field and repelled by the other, leading to a deflection towards the positive coil. The actual coils are extended over arcs of 120° . The arcs are used to generate a homogeneous magnetic field.

By arranging the coils in sets of two, mounted perpendicular to each other (X and Y directions), the beam can be deflected into any direction by a suitable combination of x and y. The deflection coils are always mounted in sets of two above another (so-called double deflection coils). Use of double deflection coils involves the important concept of [pivot points](#) as explained below.

Each microscope has three sets of double deflection coils: the [gun coils](#) just underneath the electron gun (or underneath the high-tension accelerator in case of 200 or 300 kV instruments); the [beam deflection coils](#) above the objective lens; and the [image deflection coils](#) below the objective lens. An additional, more simple, one-directional coil forms the microscope shutter that is used for exposure of the negatives.

Pivot points

Double deflection coils are capable of two completely independent actions, a tilt and a shift. These two actions should be decoupled, that is, when a shift is intended only a shift and no tilt should occur (a pure shift) and vice versa (pure tilt).

Examples of the importance of pure shift are:

- High-resolution imaging, where a beam tilt would undo all the effort spent in correctly aligning the objective lens.
- Scanning, where a tilt in addition to the beam shift will change the magnification.
- TEM dark-field imaging, where a beam shift with an additional beam tilt would change the incident-beam direction and thus the nature of the diffracting condition.

Because of the importance of pure shift and pure tilt, considerable effort is spent in correctly aligning the deflection coils. No two electron microscope columns are exactly identical and slight differences that exist between deflection coils make it necessary to align the coils by means of setting **pivot points**. A pivot point is simply a point around which the beam will pivot (like the analogue of the seesaw in the children's' playground). The alignment of the pivot point determines the relation between the two coils used, making sure that the beam pivots around the correct point.

The concept of the pivot point is probably easiest to understand for beam deflection coils in a simplified microscope consisting of a double deflection coil followed by a lens with equal distances between the deflection coils and between the lower coil and the image plane above the lens. A beam shift comes about by deflecting the beam through an angle α by the upper coil and then doing the reverse ($-\alpha$) with the lower coil. In a perfect system the beam would come out parallel to its initial direction but displaced sideways. Since all beams that are parallel at the image plane must go through a single point in the back-focal plane, shifting the beam should have no effect on the location of the beam in the back-focal plane.

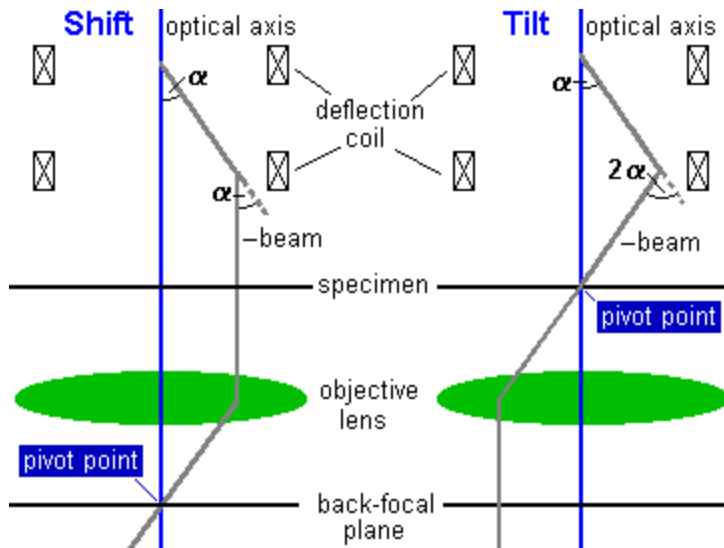

A beam tilt comes about by deflecting the beam through an angle α with the upper deflection coil and then deflecting by -2α by the lower coil. A beam tilt will result in a beam shift in the back-focal plane but should cause no shift in the image plane. If a combination of beam shift and beam tilt is needed, then the settings for these are simply added. In the example above, setting beam tilt plus beam shift would involve setting an angle 2α on the upper coils and -3α on the lower coil.

Setting the pivot points is done by deflecting the beam with a wobbler and minimizing any movement - of the beam in the diffraction plane in the case of beam shift (no tilt should occur) and of the beam in the image in the case of beam tilt (no shift should occur). A wobbler is a mechanism for rapidly switching a microscope element or function from a negative value to an identical but positive value; it can thus be on beam shift or beam tilt, image shift, a stigmator, objective-lens current, high tension, etc., even though the traditional meaning is the beam-tilt aid for focusing the TEM image.

Since a beam tilt is visible in diffraction as a diffraction shift, beam shift pivot points are set in diffraction mode, while beam tilt pivot points are set in image mode - where a beam shift will be visible.

Where important, pivot point alignment has two adjustable directions - a main one and the perpendicular correction. If the coils were perfect, the latter would not be necessary. In practice a small correction may be needed, because the lower coil is rotated slightly relative to the upper one. If the perpendicular correction is unnecessary (e.g. for the gun tilt pivot points), then only the main direction is adjustable (only the Multifunction X knob works).

Gun coils

The gun deflection coils are situated directly underneath the anode in the case of a Tecnai 10 or 12 and below the high-tension accelerator in the case of Tecnai 20, F20, 30 and

F30. These coils perform two functions. They make sure that the electron beam enters the microscope (that is, the C1 lens) parallel to the optical axis by means of the gun tilt and that the beam goes through the center of the C1 lens by means of the gun shift.

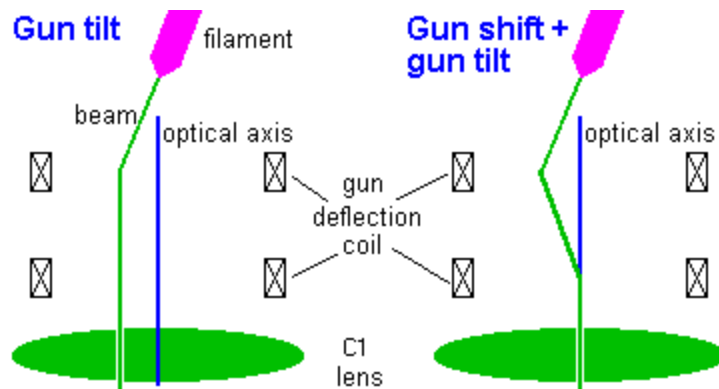

Beam coils

The beam deflection coils, situated above the objective lens, serve many purposes. They shift and tilt the beam, both static and dynamic (the latter in most of the scanning modes), are used for aligning the objective lens, and correct beam movement caused by the [condenser stigmator](#). They play a role therefore in many alignment steps. In addition, the beam deflection coils can be used coupled to the image deflection coils in a number of instances, for example for image shift or descanning.

Image coils

The image deflection coils, situated below the objective lens, have many uses. They shift the image and the diffraction pattern, to align various magnifications, camera lengths and modes (such as TEM and STEM), they correct image or diffraction-pattern movement caused by the [objective](#) and [diffraction](#) stigmators, respectively, and set the Detector alignments that move the image or diffraction pattern to a detector that is situated off the microscope axis (STEM BF/DF, TV). In addition, the image deflection coils can be used coupled to the beam deflection coils in a number of instances, for example for image shift or descanning.

Stigmators

Even though considerable effort is spent in order to ensure high lens quality, none of the lenses in a microscope is 100 percent perfect. Small inhomogeneities remain or can come about later, for instance by dust adhering to a pole piece or by magnetism or charging of

the specimen itself. These imperfections cause a loss of rotational symmetry of the lens. In one direction the lens will therefore focus more strongly than in the perpendicular direction, causing an asymmetry called astigmatism. This image defect is corrected by the stigmator.

The stigmator consists of a quadrupole, which basically is a lens whose astigmatism can be varied continuously. The quadrupole has four elements, arranged at 90 degrees around the beam. These elements are used together in two sets, with each set lying on opposite sides of the beam. If one set is given a positive value and the other a negative, then the positive elements will attract the electrons and have a defocusing effect, while the negative elements repel the electrons and focus (green arrows). The resulting astigmatism (dark red ellipse) cancels the astigmatism in the electron lens (making the beam round: red circle). The actual design of the stigmators inside the microscope is - as with the deflection coils - more complicated and based on a magnetic field (field direction and strength shown by blue arrows). Each stigmator consists of two of the elements, one mounted above the other and rotated by 45° with respect to each other. Each of these elements is controlled by one of the Multifunction knobs (X and Y directions). The combination of two elements allows correction of the astigmatism in any direction.

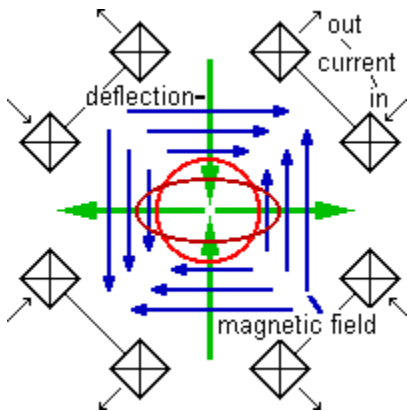

Microscopes have three sets of stigmators: the condenser stigmator to make the focused beam circular; the objective stigmator to correct astigmatism in the high-magnification (M, SA) image and the low-angle diffraction (LAD) pattern; and the diffraction stigmator to correct astigmatism in the diffraction pattern and the low-magnification (LM) image.

The quadrupoles used as stigmator can only correct second-order astigmatism. Fortunately (or perhaps logically), this is the strongest astigmatism found. Third-order astigmatism is usually apparent only in the so-called caustic image. This type of image is obtained when a strongly convergent beam is focused into a small spot, as can be the case for a diffraction pattern or nanoprobe. Occasionally, fourth-order astigmatism is observed when small, dirty objective apertures are used.

Because the stigmator settings vary from one mode to another and between various spot sizes, a number of independent stigmator values are stored by the microscope.

Three-fold stigmators

For ultra-high resolution (well below 0.2 nanometers) and very small spots on FEG instruments, it is not sufficient to correct only the two-fold astigmatism (astigmatism has many terms; since the effect of each term decreases exponentially, it is rarely necessary to correct more than two-fold astigmatism), but three-fold astigmatism as well.

Microscopes where such corrections are important are therefore often equipped with three-fold stigmatism in addition to the normal two-fold stigmatism. In these cases the normal (beam and/or objective) stigmators are replaced by a variant where opposite elements are not coupled but can be adjusted individually. By using the opposite elements coupled, two-fold stigmatism is done, while the three-fold stigmatism uses combinations of several elements, producing a seeming set of six elements. The two stigmatism settings are simply added, giving the required combination of two- and three-fold astigmatism correction.