

PHD ULTRA™

Syringe Pump Series

User's Guide

PHD ULTRA™ Series MA1 70-3xxx



PATENTS PENDING

Table of Contents

SUBJECT	PAGE NO.
Quick Guide	6
10 Things You Need To Know To Use The PHD ULTRA™	6
General Information	7
Conventions Used In This Guide	7
Warranty and Repair Information	8
Manual Description.....	8
Warranty.....	8
Repair Facilities and Parts	8
Serial Numbers.....	8
Calibrations.....	8
Safety Information.....	9
Introduction To The PHD ULTRA™ Pump	10
Product Overview – Theory of Operation	10
Pump Models.....	10
Specifications	11
Setting Up The PHD ULTRA™ With EZ PRO™	13
Physical Views	13
Power Connections and Pump Startup	14
Remote Pump Physical Connections.....	14
Navigating The PHD ULTRA™ EZ PRO™ Software.....	15
The PHD ULTRA™ Workspace.....	15
Selecting An Item From A Menu List.....	16
Information/Warning messages	17
EZ PRO™ Touch Screen Button Reference.....	18
System Setting Adjustments	19
Setting the Audible Alarms	19
Locking The Touch Screen	21
Setting the Force Limits	22
Setting the Time and Date	23
Change Logo	23
Setting Backlight Level	24
Setting Pump Address Value	24
Setting the Pump Baud Rate.....	25

Pump Information.....	26
Power Up Running.....	27
Syringe Loading.....	28
Changing the bracket for small (<30ml) vs large (>30ml) syringes:	29
Using The PHD ULTRA™	30
Pump Operation Overview	30
Overview of Methods.....	30
Method Types.....	31
EZ PRO™ Quick Start Methods.....	31
EZ PRO™ Preloaded Methods	31
EZ PRO™ User-Defined Methods.....	31
Running The Pump	32
Controlling The Pump	32
Basic Method Operations.....	32
Viewing Current Method Parameters	32
Syringe Selection	33
Syringe Gang Operation	34
Controlling The Pump Using A Stored Method	36
Using an EZ PRO™ Quick Start Method	40
Basic Operation	40
Quick Start Method Variables	41
Infuse Rate Select/Withdraw Rate Select.....	41
Target Volume/Time Select	42
Using an EZ PRO™ Preloaded/User-Defined Method	43
Preloaded/User-Defined Method Workflow	44
Setting A Time Delay For Method Operation.....	46
Creating an EZ PRO™ New Method	47
Modifying a Preloaded/User-Defined Method	49
Changing the Order of Steps in a Method.....	49
Deleting a Step From a Method	49
Duplicating a Step In a Method.....	50
Defining Method Step Parameters	50
Pump Operation Profiles	51
Constant Rate Profile	52
Ramp Profile.....	53
Stepped Profile	55
Pulse Profile	57

Bolus Profile59

Concentration Profile60

Gradient Profile.....63

Autofill Profile66

Incorporating Advanced Options (Commands and I/O) Into A Method68

 Go To Step.....68

 Delay69

 Repeat Step70

 Link Method71

 Stop71

 I/O Event Triggers.....72

 I/O Trigger (out)72

 I/O Event (in)74

 I/O Event Link (in).....75

Managing EZ PRO™ Methods76

 Saving A Copy Of A Method76

 Renaming A Method76

 Appending A Method.....77

 Deleting A Method.....77

 PHD Ultra Method Export and Import78

External Pump Control.....80

 Setting Up HyperTerminal.....80

Pump Chain Commands.....82

 Using the PHD ULTRA™ Pump Chain Commands.....82

 Error Messages83

 System Commands.....84

 Run Commands.....89

 Rate Commands.....90

 Volume Commands92

 Time Commands94

 Digital I/O Commands.....95

 Internal Commands.....96

Appendices	97
Appendix A: Syringe Volume/Diameter Reference Table.....	97
Appendix B: Stainless Steel Syringes.....	98
Appendix C: Min/Max Flow Rates.....	99
Appendix D: Syringe Holder Options.....	100
Mounting a 4x140 Multi-Rack	100
Mounting a 6/10 Multi-Rack.....	102
Syringe Loading – 4 x 140 & 6/10 Multi-Racks	104
Mounting a Microliter Multi-Rack.....	106
Syringe Loading – Microliter Multi-Rack.....	108
Syringe Loading – Push-Pull Mechanism	109
Appendix E: External connections	111
User I/O Connector Specifications.....	111
Analog Input	112
USB	113
RS-232 Specifications.....	115
Legacy RJ-11 Option.....	116
RS-485.....	117
Remote / Gradient Systems.....	118
Connecting a Remote / Satellite Pump.....	118
Setting Addresses on Remote / Satellite Units	119
Setting the Address on the Control Box / Master Unit.....	119
Appendix F: Maintenance	121
Maintenance	121
Fuse Replacement.....	122
Battery Replacement	122
Troubleshooting	123
Upgrading EZ PRO™ Software.....	124
PHD ULTRA™ Display Error Messages.....	125
Appendix G: Satellite Boxes.....	126
Master / Satellite Configurations.....	127
Optional PC-to-Pump Configurations	128
Appendix H: Remote Stand	129
Appendix I: Ordering Information	131

Quick Guide

10 THINGS YOU NEED TO KNOW TO USE THE PHD ULTRA™

Since many of our users are already familiar with the operation of a syringe pump, we've created this one-page summary of important tips for using the PHD ULTRA™.

Operations Display: this section of the screen is used to display pump operations, method information, general parameter settings and the real-time display of data while the pump is running.

Message Area: this section is used to display the pump name, the time/date display and the message box which contains operational messages while the pump is running.

Run Preview: Access the Method Preview screen that shows a summary of steps and operating parameters.

Run/Resume: Used to Run or Resume a Method.

Fast Forward: Advances the Pusher Block in the forward (infuse) direction.

Fast Reverse: Advances the Pusher Block in the reverse (withdraw) direction.

Back: Used to go back one screen.

Touch Screen Unlocked: Indicates that the Touch Screen is currently unlocked. Pressing the button twice locks the Touch Screen.

Settings: Access the settings menu used to adjust Date, Time, Audible Alarm, Pusher Block Force, Backlighting, etc.

Set Delay Parameters: Used to set the date and time values for delayed operation. This permits the pump to start automatically on the date/time selected.

Navigation Buttons: this area of the touchscreen contains the buttons used to navigate through the software menus and to start/stop pump operations.

1. **Navigation Buttons.** Review the Touch Screen Button Reference on Page 18 of this manual to familiarize yourself with the onscreen navigation commands. Once you know the buttons, you'll be able to navigate freely in the system.
2. **Select and Choose.** Menus on the PHD ULTRA™ that require selection from a list use a "persistent double touch" to select an item. That means that you will touch the desired item once to highlight it, then a second time to confirm your choice. Most other commands only require that you touch one time to choose that function.
3. **Home.** The "Home" screen in the PHD ULTRA™ software is the Method Main or Quick Start screen. This screen displays the currently selected Method along with its current parameter settings. To change Methods, choose the Method Select button.
4. **Running A Method.** To run a Method, choose the Run button. It will point left or right depending on whether the first operation is a Withdraw (left) or Infuse (right) Step. If all the required parameters for the Method are not set, the Run button will be inactive (grayed out).
5. **Lost?** If you start navigating and suddenly you feel lost, choose the Cancel button or the Back Button. Do that enough and eventually you will be back to the Method Main screen or Quick Start screen!
6. **Watch the Force.** The PHD Ultra generates up to 75 lbs of force...enough to damage delicate syringes. A Force Limit command in the Settings menu allows you to control the maximum force value.
7. **Get The Message.** The Message Area on every screen provides a summary of what you are supposed to do...and many screens offer warnings or cautions if you do something wrong.
8. **Set Your Syringe.** One of the most basic selections on the system is choosing the syringe that is loaded. This setting is persistent across all Quick Start Methods (the ones we loaded to help you get started fast!). That means it will be the default syringe choice in every Quick Start Method once you set it up. However, User-Defined Methods save their own syringe settings. If you are creating a New Method, the default syringe will be the syringe selected for Quick Start Methods.
9. **Get Connected.** If you are using the PHD Ultra in conjunction with external devices (ones you want to trigger or ones that you will respond to), there are commands available to simplify the setup of these connections. The Advanced Options in the Method Steps Profiles section of this manual describe these functions.
10. **Manual Pumping.** Buttons for manual control of the pump (for fast infusion or fast withdrawal action) are available on many screens in the application.

General Information

CONVENTIONS USED IN THIS GUIDE

This guide describes basic procedures for operating the PHD ULTRA™ Syringe Pump, including both hardware operations and software operations accessed through the pump's touchscreen display. This section discusses important conventions used in this guide.

Capitalization

All menus, commands, and dialog box option names appear with initial capital letters whether or not they are completely capitalized in the user interface. This includes navigation buttons and menu selection buttons/selection lists on the touchscreen display. This will help you to distinguish these items from narrative or procedural text.

Terminology

Throughout the PHD ULTRA™ documentation, the following terms are used to refer to program elements and the actions that you perform to carry out tasks:

- **Method** — A Method is the collection of steps and parameters that constitute the operating instructions to the pump while being used to infuse or withdraw liquids.
- **Choose** — The terms choose and select indicate actions that you perform using the touchscreen interface. Choose represents carrying out an action associated with a parameter or navigation button. Choose will be used when the choice you make is automatically executed. For example, “Choose the Method Select” button automatically brings you to the Method Selection screen on the touchscreen. When you are likely to use the touchscreen to enter alphanumeric data (e.g. a Method name or a parameter numerical value through a simulated keyboard or number pad), the specific key is mentioned, or we indicate you should “enter” your desired values.
- **Select** — The term select refers to highlighting an item or moving the button focus on the touchscreen. Selecting an item prepares it for an action and requires a second touch on the touchscreen to confirm the selection. For example, when you “select” the Syringe Manufacturer/Brand on the Syringe Selection screen, it is first highlighted in magenta. Pressing the selected choice a second time confirms/accepts the selection. You can also press the Accept button to confirm the selection. We will use the term “select” to refer to this double-press or press/confirm action throughout this guide.

Illustrations

Unless otherwise indicated, the values in the illustrations of this manual are examples only. They are not intended to indicate the exact values you will see or to suggest the values you should use.

Special Messages/Callouts

The following special messages and callouts appear throughout the guide to indicate information that requires special attention:



Warnings or hazard instructions provide information to help you avoid personal injury or damage to the PHD ULTRA™ Pump during operation.



Notes provide helpful instructions that can help you make better use of the PHD ULTRA™ pump.

WARRANTY AND REPAIR INFORMATION



CAUTION: Refer to safety information and setting up the PHD ULTRA™ before plugging in PHD ULTRA™ pump.

Manual Description

This manual is designed to provide all operational and program information required to operate and maintain the PHD ULTRA™ series pumps. The functions and features are described in the Technical Specifications section.

Warranty

Harvard Apparatus warranties this instrument for a period of two years from date of purchase. At its option, Harvard Apparatus will repair or replace the unit if it is found to be defective as to workmanship or materials. This warranty does not extend to damage resulting from misuse, neglect or abuse, normal wear and tear, or accident. This warranty extends only to the original consumer purchaser.

IN NO EVENT SHALL HARVARD APPARATUS BE LIABLE FOR INCIDENTAL OR CONSEQUENTIAL DAMAGES. Some states do not allow the exclusion or limitation of incidental or consequential damages so the above limitation or exclusion may not apply to you. **THERE ARE NO IMPLIED WARRANTIES OF MERCHANTABILITY, OR FITNESS FOR A PARTICULAR USE, OR OF ANY OTHER NATURE.** Some states do not allow this limitation on an implied warranty, so the above limitation may not apply to you.

If a defect arises within the two-year warranty period, promptly contact Harvard Apparatus, 84 October Hill Road, Holliston, Massachusetts 01746 using our toll free number 1-800-272-2775, or outside the U.S. call 508-893-8999. Email Address is bioscience@harvardapparatus.com. Goods will not be accepted for return unless an RMA (returned materials authorization) number has been issued by our customer service department. The customer is responsible for shipping charges for non-warranty repairs. Please allow a reasonable period of time for completion of repairs or replacement. If the unit is replaced, the replacement unit is covered only for the remainder of the original warranty period dating from the purchase of the original device.

This warranty gives you specific rights, and you may also have other rights which vary from state to state.

Repair Facilities and Parts

Harvard Apparatus stocks replacement and repair parts. When ordering, please describe parts as completely as possible, preferably using a part number obtained from our Technical Support department. If practical, enclose a sample part or sketch. We offer a complete reconditioning service.

Serial Numbers

All inquiries concerning our product should refer to the serial number of the unit, located on the rear panel.

Calibrations

All electrical apparatus are calibrated at rated voltage and frequency. While the flow and volume will stay calibrated, the peak pressure may vary. Harvard Apparatus recommends an annual calibration of the pump.



CAUTION: For research use only. Not for clinical use on patients.

SAFETY INFORMATION

Please read the following safety precautions to ensure proper use of your syringe pump. If the equipment is used in a manner not specified, the protection provided by the equipment may be impaired.

To Prevent Hazard or Injury:

Use Proper Line Cord

Use only the specified line cord for this product and make sure line cord is certified for country of use. The operating voltage range for the PHD ULTRA™ is 100-240 vac, 50-60 Hz (See Note 1).

Ground the Product

This product is grounded through the grounding conductor of the power cord. To avoid electric shock, the grounding conductor must be connected to earth ground. Before making any connections to the input or output terminals of the product, ensure that the product is properly grounded (See Note 1).

Make Proper Connections

Make sure all connections are made properly and securely. Any signal wire connections to the unit must be no longer than 3 meters (except RS485 pump-to-pump communication cable).

Observe All Terminal Ratings

Review the operating manual to learn the ratings on all connections.

Use Proper Fuse

Use only specified fuses with product.

Avoid Exposed Circuitry

Do not touch any electronic circuitry inside of the product.

Avoid Pinch Hazard

A pinch hazard may exist between the pusher block and end blocks. Avoid placing fingers between these points while the pump is running.

Do Not Operate with Suspected Failures

If damage is suspected on or to the product do not operate the product. Contact qualified service personnel to perform inspection.

Orient the Equipment Properly

Do not orient the equipment so that it is difficult to manage the connection and disconnection of devices.

Place Product in Proper Environment

Review the operating manual for guidelines for proper operating environments.

Observe all Warning Labels on Product

Read all labels on product to ensure proper usage.



CAUTION
Refer to Manual



*Protective Ground
Terminal*



NOTE 1: Satellite and Remote units are DC powered through the RS-485 cable. Earth ground connection is through this cable for these units.

Introduction To The PHD ULTRA™ Pump

PRODUCT OVERVIEW – THEORY OF OPERATION

The PHD ULTRA™ Syringe Pump series is a family of high-accuracy, microliter- and milliliter-compatible pumps designed for versatile technical use including mass spectroscopy, calibration, drug and nutritional infusions, microdialysis, dispensing, chromatography and LC/HPLC. The PHD ULTRA™ incorporates a microprocessor controlled, small step angle stepping motor that drives a lead screw and Pusher Block. Advanced micro-stepping techniques are employed to further reduce the step angle to eliminate flow pulsation. The pump is engineered to provide flow accuracy within 0.35% and reproducibility within 0.05%.

The PHD ULTRA™ uses a touchscreen interface and advanced software to control operation. External I/O interfaces permit external control via an independent computer or device. The application software provides convenient selection of common syringe models from a Syringe Lookup Table, as well as insertion of custom syringe specifications. The system is then able to calculate the cross-sectional area of the syringe selected and calibrate the flow rate and volume accumulation, displaying real-time operating characteristics via on-screen graphics.

PUMP MODELS

The PHD ULTRA™ Syringe Pump is available in three models designed for different operating environments and varying degrees of operational flexibility.

- **Infusion Only:** This model supports infusion operations at user-definable flow rates and with selectable target volume or time values to control the total infusion volume. The entry-level Infusion Only model does not include programmable, user-defined methods.
- **Infusion/Withdrawal:** This model supports infusion and withdrawal operations at user-definable flow rates and with selectable target volume or time values to control the total volume pumped for both the infusion and withdrawal portions of a procedure. This model provides access to many of the advanced method programming options of the PHD ULTRA™, but only supports a single stored Method.
- **Infusion/Withdrawal Programmable:** This model supports both infusion and withdrawal operations, and can use both simplified pumping profiles or the more advanced pumping profiles and I/O settings that permit interactions with external devices. In addition to supporting all of the advanced programming tools available on the PHD ULTRA™, this model also allows users to create and store multiple user-defined Methods on the pump.



NOTE: This manual has been written to accommodate Infuse/Withdraw/Programmable configurations. Where features/capabilities are not available in the Infuse Only or Infuse/Withdraw basic models, we have identified that in the manual.

PUMP CONFIGURATIONS

The PHD ULTRA™ Syringe Pump is available in the following configurations:

- **Standard Pump:** This configuration is the most common. It consists of a single unit with the syringe pumping mechanism attached to the top of the control box.
- **Remote Pump:** This configuration is a two piece unit, with the syringe pumping mechanism and the control box separated by a 2 meter cable. One meter and 0.5 m cables are available for purchase separately.
- **Push/Pull Pump:** This configuration consists of a single unit with the syringe pumping mechanism attached to the top of the control box. The pump can hold up to four syringes; 2 on either side of the pusher block. The pump can simultaneously infuse and withdraw the exact same amount.
- **Satellite Pump Units:** Satellite units consist of a syringe pumping mechanism and control electronics but do not have a user interface. They are powered and controlled from a master/stand-alone PHD ULTRA™ via the RS-485 cable.

PHD ULTRA™ Specifications		
	Stand-Alone	Satellite / RS-485 Remote
Accuracy	± 0.25%	± 0.25%
Reproducibility	± 0.05%	± 0.05%
Syringes:		
Minimum	0.5 µl	0.5 µl
Maximum	140 ml	140 ml
Flow Rate:		
Minimum (0.5 µl syringe)	1.5 pl/min	1.5 pl/min
Maximum (140 ml syringe)	216 ml/min	216 ml/min
Display	4.3" WQVGA TFT Color Display w/Touch Screen	N/A
Non-Volatile Memory	Stores all settings	Stores all settings
Connectors:		
RS-232	9 pin D-Sub Connector	N/A
RS-485	IEEE-1394, 6 pos	IEEE-1394, 6 pos
USB	Type B	Type B
I/O & TTL	15 pin D-Sub Connector	15 pin D-Sub Connector Option
Linear Force (Max):	34 kg (75 lbs) @ 100% Force Selection	34 kg (75 lbs) @ 100% Force Selection
Drive Motor	0.9° Stepper Motor Controlled	0.9° Stepper Motor Controlled
Motor Drive Control	Microprocessor with 1/16 microstepping	Microprocessor with 1/16 microstepping
Motor Micro Steps per one rev. of Lead Screw	12,800	12,800
Step Rate:		
Minimum	27.5 sec/µstep	27.5 sec/µstep
Maximum	26 µsec/µstep	26 µsec/µstep
Pusher Travel Rate:		
Minimum	0.18 µm/min	0.18 µm/min
Maximum	190.80 mm/min	190.80 mm/min
Power	100-240 VAC:50-60 Hz 50 W, 0.5 A fuse	12-30 VDC ± 5% Input Power at RS-485
Dimensions		
Control Box	12.0 x 8.5 x 7.0 in (30.5 x 21.6 x 17.8 cm)	12.0 x 8.5 x 4.25 in (30.5 x 21.6 x 10.8 cm)
Remote Box	N/A	11.75 x 5.5 x 6.5 in (29.8 x 14.0 x 16.5 cm)
Weight	4.5 kg (10 lbs)	4.8 kg (10.49 lbs)

PHD ULTRA™ Specifications (continued)		
	Stand-Alone	Satellite / RS-485 Remote
Atmospheric Specifications:		
Operating Temperature	4°C to 40°C (40°F to 104°F)*	4°C to 40°C (40°F to 104°F)
Storage Temperature	-10°C to 70°C (14°F to 158°F)	-10°C to 70°C (14°F to 158°F)
Operating Humidity	See Chart Below	See Chart Below
Storage Humidity	20% - 80% RH, non-condensing	20 - 80% RH, non-condensing
Mode of Operation	Continuous	Continuous
Classification	Class I	Class I
Pollution Degree	1	1
Installation Category	II	II
Supplier Name	Harvard Apparatus	Harvard Apparatus
Supplier Address	84 October Hill Road, Holliston, MA 01746	84 October Hill Road, Holliston, MA 01746
Regulatory Certifications	CE, ETL (UL, CSA), WEEE, EU RoHS & CB Scheme	CE, ETL (UL, CSA), WEEE, EU RoHS & CB Scheme
Safety Declarations	ANSI/UL 61010-1 Ed. 3 ; CAN/CSA C22.2 No. 61010-1 Ed. 3 ; IEC 61010-1 Ed. 3 ; CENELEC EN 61010-1 ; CB Scheme	ANSI/UL 61010-1 Ed. 3 ; CAN/CSA C22.2 No. 61010-1 Ed. 3 ; IEC 61010-1 Ed. 3 ; CENELEC EN 61010-1 ; CB Scheme
EMC Declaration	IEC 61326-1 Ed 1, FCC 47CFR 15B Class A	IEC 61326-1 Ed 1, FCC 47CFR 15B Class A

*Fan option is required if external operating ambient is expected to be > 35 °C.

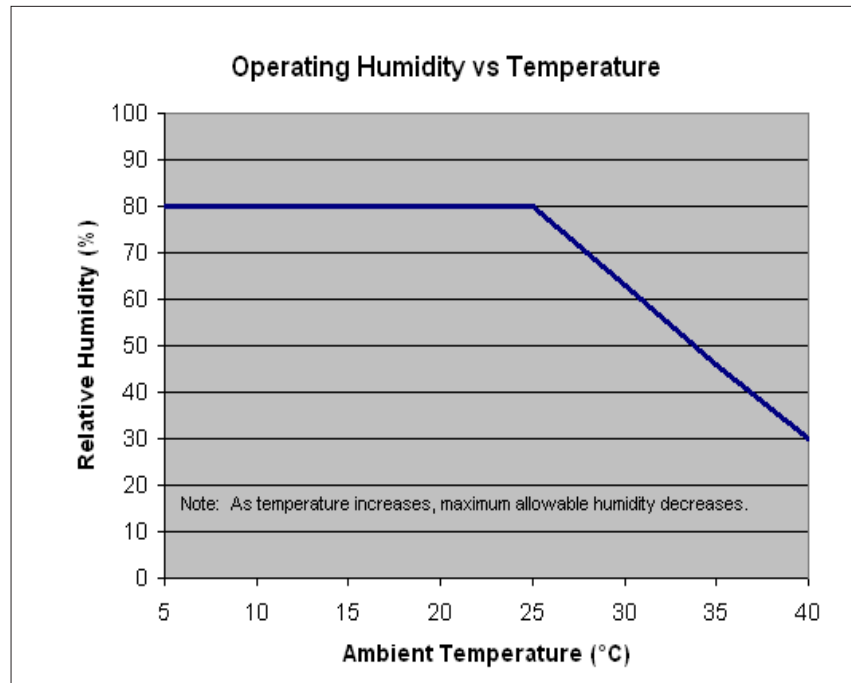

NOTE: This equipment has been tested and found to comply with the limits for a Class A digital device, pursuant to part 15 of the FCC Rules. These limits are designed to provide reasonable protection against harmful interference when the equipment is operated in a commercial environment. This equipment generates, uses, and can radiate radio frequency energy and, if not installed and used in accordance with the instruction manual, may cause harmful interference to radio communications. Operation of this equipment in a residential area is likely to cause harmful interference in which case the user will be required to correct the interference at his own expense.

SPECIFICATIONS

Setting Up The PHD ULTRA™ With EZ PRO™

PHYSICAL VIEWS

The following diagrams show the important components of the PHD ULTRA™ pump.

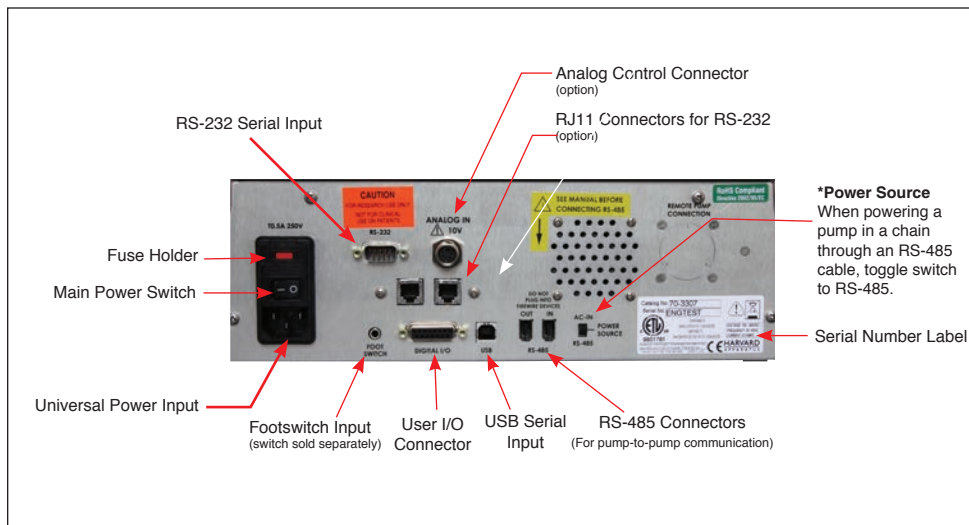

Rear view of the PHD ULTRA™ pump showing important connections.



Front view of the PHD ULTRA™ pump showing important components and controls.

POWER CONNECTIONS AND PUMP STARTUP



CAUTION: Do not connect to firewire devices. Damage may occur to pump or device.

The operating voltage range for the PHD ULTRA™ is 100 - 240 VAC, 50-60 Hz. Use only the specified line cord for this product and make sure line cord is certified for country of use.

1. Plug the power cord into the Universal Power Input connector on the rear of the PHD ULTRA™.
2. Turn on main power switch located in the upper left corner of the rear panel.
3. The PHD ULTRA™ touchscreen display will illuminate and display the startup screen while performing initial self-diagnostics. When complete, the unit will display either the Quick Start screen or the Method Main screen.

REMOTE PUMP PHYSICAL CONNECTIONS

RS-485 Remote System



To connect an RS-485 remote system:

1. On the control box, connect the RS-485 cable to 'RS-485 OUT' connector.
2. On the remote unit, connect the RS-485 cable to 'RS-485 IN' connector.

NAVIGATING THE PHD ULTRA™ EZ PRO™ SOFTWARE

The PHD ULTRA™ uses a high resolution touchscreen with an icon-enabled graphical user interface and an advanced methods architecture to streamline simple to complex tasks.

The PHD ULTRA™ Workspace

The PHD ULTRA™ touchscreen interface is divided into three basic areas:

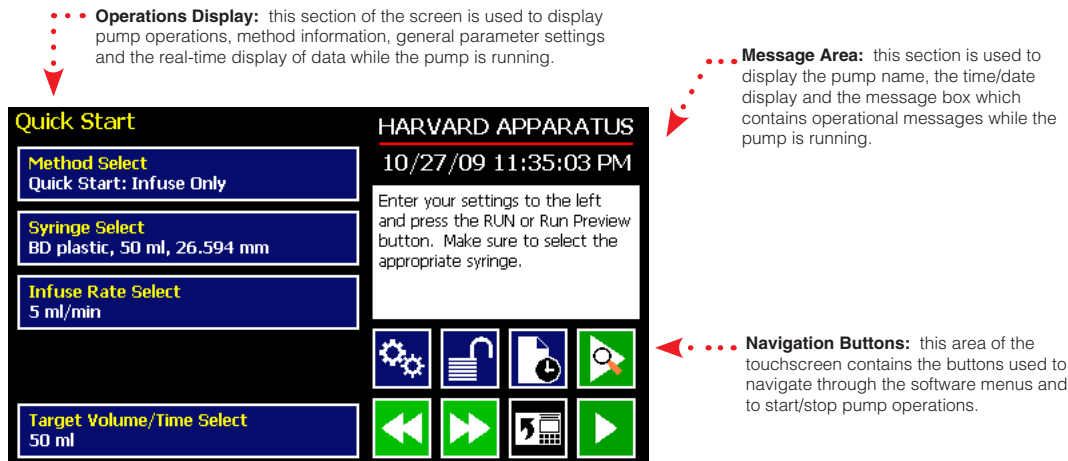

The PHD ULTRA™ Touch Screen Display. The screen shown is the Quick Start display.

The PHD ULTRA™ touchscreen with EZ PRO™ Software allows you to navigate through all menu selections and data entry by gently touching the onscreen buttons with a finger or the tip of a soft, non-sharp object such as a pencil eraser.

The software is organized into three main navigational branches:

- Quick Start Operations
- Preloaded/User-Defined Methods
- Systems Settings

The Method Main or Quick Start screens are the primary “home” for the applications. From those screens, you can access all the commands needed to operate the PHD ULTRA™, as well as the main system settings.

From anywhere in the applications, you can return to the Quick Start or Method Main screens by:

- Choosing the Cancel or Home/Back buttons one or more times until you reach the Method Main or Quick Start screens.
- Choosing Method Select and making a selection from the Method options available.

The PHD ULTRA™ supports touchscreen orientation auto-rotation (landscape/portrait) for permitting easy use of the pump when positioned upright on its side. This configuration and the associated touchscreen display are shown in the following figure.



The PHD ULTRA™ pump shown in its vertical (upright) orientation and the associated Quick Start menu screen showing the application auto-rotated into portrait mode.

SELECTING AN ITEM FROM A MENU LIST

Some sections of the PHD ULTRA™ software display a list of choices from which you select. These menus require that you first “select” the item that you want. When you do this, the item you have selected is highlighted in magenta on the screen. To confirm your selection, you must choose the Accept button or touch the item a second time.

An example of the two-step selection process with a button color displayed in purple is shown below:

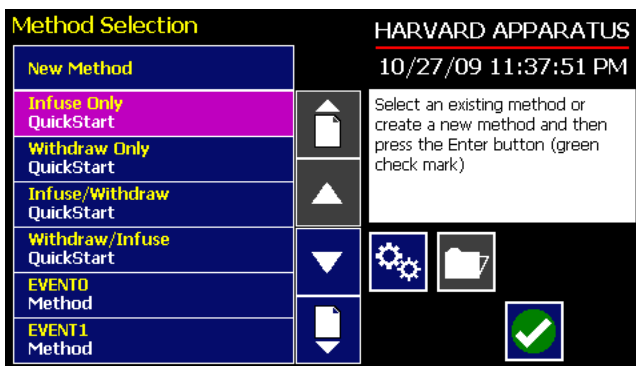

The EZ PRO™ Method Selection screen showing a button highlighted after a single touch.

INFORMATION/WARNING MESSAGES

The Message Area of the touchscreen is used to display helpful instructions for the currently displayed screen. It is also used to display error or warning messages to indicate problem conditions in a Method or error conditions during pump operation. The Message Area is displayed in yellow when one of these warning messages is displayed.



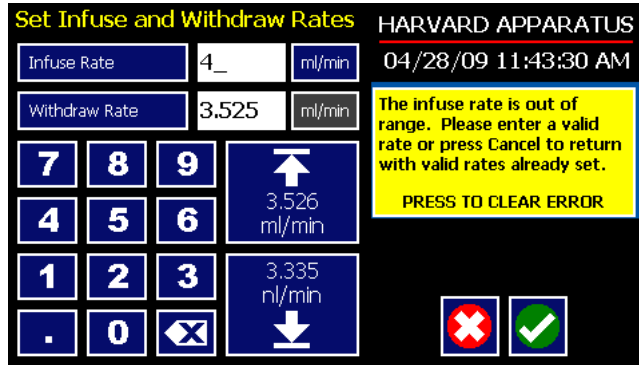























An example of an informational warning is shown below:



The Set Infusion and Withdrawal Rates screen showing an out-of-range setting condition in the Message Area. The informational warning is displayed in yellow.

EZ PRO™ Touch Screen Button Reference

The following buttons are part of the PHD ULTRA™ software

	Settings: Access the settings menu used to adjust the following parameters: Date and Time, Audible Alarms, Pusher Block Force, Backlighting, RS-232 Communications, etc.		Page Down: Used to page down in a display list.
	Fast Forward: Advances the Pusher Block in the forward (infuse) direction.		Page Up: Used to page up in a display list.
	Fast Reverse: Advances the Pusher Block in the reverse (withdraw) direction.		Scroll Up: Used to scroll up in a display list.
	Accept: Used to accept the parameters/settings on a screen and advance to next screen in the menu.		Scroll Down: Used to scroll down in a display list.
	Cancel: Used to cancel any changes/entries on a screen and return to the previous screen in the menu.		Insert Step: Used to insert a new Step in a Method while editing/creating the Method. The new Step is inserted after the Step that is currently selected.
	Back: Used to go back one screen.		Delete Step: Used to delete the selected Step in a Method while editing/creating the Method. To confirm deletion, you must select the Delete Step button a second time.
	Set Delay Parameters: Used to set the date and time values for delayed operation. This permits the pump to start automatically at a preset date and time.		Move Step Up: Moves the currently selected Step in a Method up one position in the Method Order (e.g. Step 3 becomes Step 2).
	Set Delay Parameters: Indicates the Delay Timer has been set. The pump will start automatically on the day/time selected.		Move Step Down: Moves the currently selected Step in a Method down one position in the Method Order (e.g. Step 2 becomes Step 3).
	Run Preview: Access the Method Preview screen that shows a summary of steps and operating parameters.		Copy Step: Creates a duplicate (copy) of the currently selected Step in a Method and inserts it as the last Step in the Method being created/edited.
	Run/Resume: Used to Run or Resume a Method.		Touch Screen Unlocked: Indicates that the Touch Screen is currently unlocked. Pressing the button twice locks the Touch Screen.
	Re-Run: Clears counters/timers and runs the selected method from the beginning.		Touch Screen Locked: Indicates that the Touch Screen is currently locked. Press the button and enter password to unlock the Touch Screen.
	Stop: Used to stop running a Method.		File Options: Access the File Options menu that is used to manage the list of Methods and to export Method information to an externally linked pump or to a connected computer.
	Clear: Clears the counters/timers.		
	Minimum Value Allowed: Used to select minimum value allowed.		
	Maximum Value Allowed: Used to select maximum value allowed.		

SYSTEM SETTING ADJUSTMENTS

The PHD ULTRA™ Settings menu is used to control basic system operations. This section describes the options available in this section of the application software.

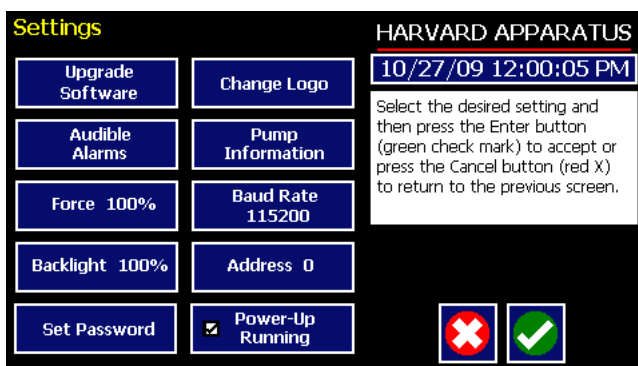

The Settings screen.

Setting the Audible Alarms

The PHD ULTRA™ pump incorporates an Audible Alarm feature that can be used to warn the operator about various operating conditions, errors and power outages. The following alarms are user configurable in the Settings section of the application:

- **End-of-Run:** An alarm will sound when a Method run is completed. Touch anywhere on touchscreen to silence the alarm.
- **Power Fail:** An alarm will sound if power to the PHD ULTRA™ is lost while the pump is running. Pressing any button on the screen silences this alarm.
- **Motor Stall:** An alarm will sound to notify the operator of any motor stall.
- **Keypad Clicks:** A soft beep indicates a positive touch on any button on the screen.
- **Near End-of-Run:** This alarm (3 beeps) can be custom configured to notify the operator that a Method is near-completion. The user can select from preset values of 75, 80, 85, 90 or 95% completion, or can set a custom value using the touchscreen.
- **Calibration Reminder:** This alarm is used to inform the user that the system has reached its scheduled Calibration date. It is checked at each power-up.
- **Mute All:** Selecting this option mutes all audible alarms. When selected, the Mute All button is indicated with a checkmark and the remaining buttons on the screen are greyed out.

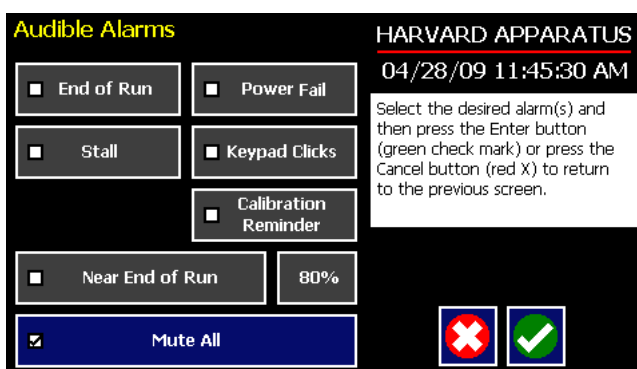

Set Audible Alarms screen showing the available options and with Mute All selected. The remaining alarm options are greyed out in this example.

TO SET THE USER-CONFIGURABLE AUDIBLE ALARMS:

1. In the Audible Alarms menu, select the specific alarm or alarms that you wish to set. On the Settings screen, select Touch Screen Lock Enable. Note that a checkbox on the button will be checked to indicate that you have selected an option, but the button will not be displayed in magenta as with other “select” options in the software.
2. If you select the Near End of Run Alarm, choose the Percentage Set button to access the Near End of Run Select menu that is used to define at what point in the Method the alarm will sound. Select a preset value (75%, 80%, 85%, 90% 95%) or choose Set Other Value and Enter the desired Percent Done value using the keypad. If you choose Set Other Value, choose the Accept button when finished. When you have made your selection on the Near End of Run Select screen, choose the Accept button to complete your changes.

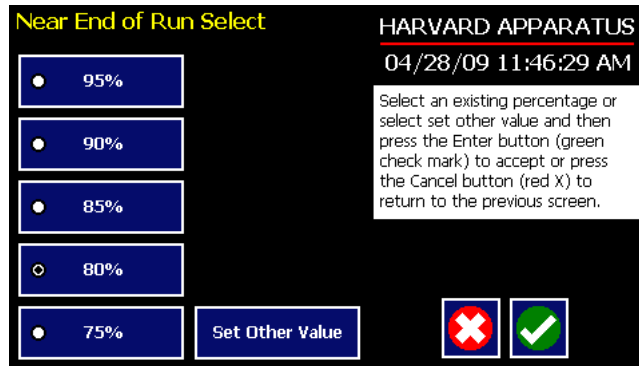

Set Audible Alarms Near End of Run Select screen showing the preset options and the Set Other Value button.

Locking the Touchscreen

A touchscreen lock function can be enabled to prevent accidental operation or interruption of operation. Unlocking the touchscreen requires a password, defined by the user.

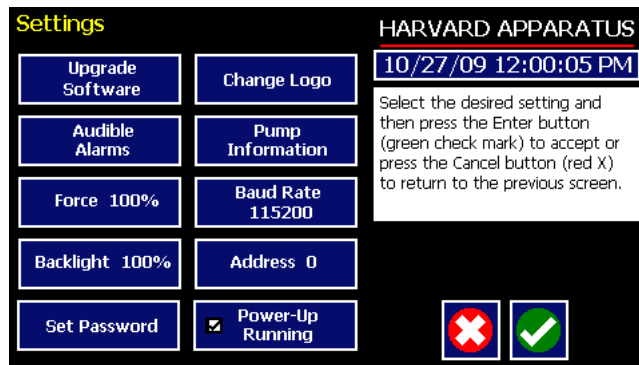

SETTING THE PASSWORD

To set the Password go to the Settings screen. Press the Set Password button

Enter your desired password, up to 8 digits, and press the 'enter' button.



TURNING THE TOUCHSCREEN LOCK ON

Press the Lock button twice to lock the touchscreen.

Methods can be started and stopped while the touchscreen is locked. Method parameters can not be changed while the touchscreen is locked.

Password Lock Button

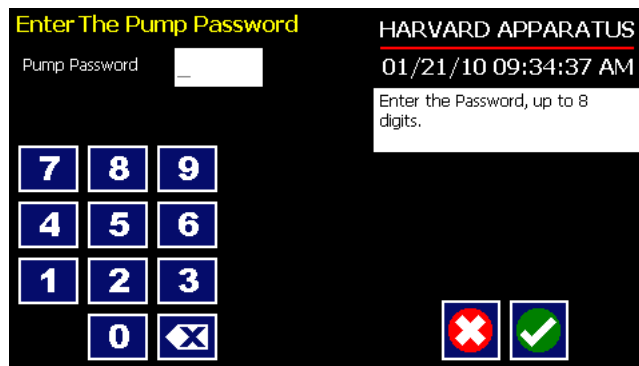

TURNING THE TOUCHSCREEN LOCK OFF

Press the 'Lock' button to bring up the Enter the Pump Password screen.

Enter your password and press the 'Accept' button.

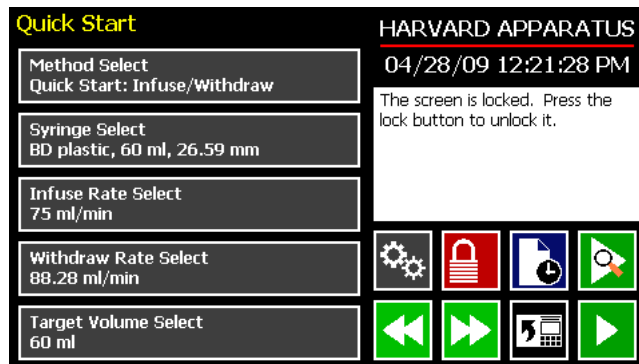

NOTE: If you forget your password contact Harvard Apparatus Technical Support at 508-893-8999.

Setting the Force Limits

The PHD ULTRA™ motor generates up to 75 lbs of linear force in operation. This force is sufficient to damage delicate, low-volume syringes, as well as many standard syringes if pumping viscous fluids. The application software provides controls to allow you to set a maximum force value (calculated as a percentage of the maximum value).

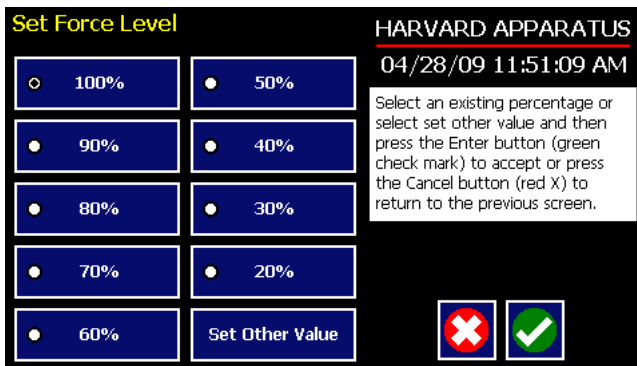

 **NOTE:** For firmware versions prior to 1.3.0, when Satellite units are connected to Master, Force Setting only affects force limit on Master. Satellites retain last set value. Default force 50%.

TO ADJUST THE MAXIMUM FORCE SETTING:

1. From the Quick Start or Method Main screen, choose the Settings button.
2. From the Settings menu, choose the Force button to enter the Set Force Level screen.
3. Select the desired preset level value or use the Set Other Value button to enter a custom force level.
4. If you select Set Other value, enter the desired force setting as a percentage value (1-100%) then choose Accept to confirm your setting.
5. When you have selected or entered the desired force value, choose Accept to return to the Settings menu.

<i>Suggested Force Level Settings for Common Syringes</i>			
<i>Syringe Type/Material</i>	<i>Capacity</i>	<i>Force Setting</i>	<i>Common Manufacturer(s)</i>
Plastic Syringes	≤20 ml	50%	BD plastic, Sherwood, Airtite, Terumo
	>20 ml	100%	
Stainless Steel	All	100%	Harvard Apparatus
Glass/Glass	≤20 ml	20%	Cadence (Popper)
	>20 ml	30%	
Glass/Plastic	≤1000 µl	30%	Hamilton, SGE
	≤5 ml	50%	
	>5 ml	100%	

Suggested Force Level Settings for Common Syringes.

Setting the Time and Date

The PHD ULTRA™ displays the date and time on each screen in the user interface. Built-in battery backups maintain the date and time even if the pump loses power or is unplugged for a period of time.

If it is necessary to set the date and time values, follow the instructions below.

TO SET THE DATE AND TIME DISPLAY:

1. From the Quick Start or Method Main screen, choose the Settings button.
2. On the Settings screen, choose the Date/Time Display box to enter the Set Date and Time screen.
3. To change the Date, select the Date button and enter the Date values using the keypad in the format defined by the date Format button to the right of the Date entry box. You can toggle between m/d/y (Month/Day/Year), d/m/y (Day/Month/Year) and y/m/d (Year/Month/day) display by successive selection of the Date Units button.
4. To change the Time, select the Time button and enter the current time in hh:mm:ss (hours:minutes:seconds) format. Select the Time Format button to toggle between AM, 24 Hour and PM values for the Time.
5. When the Date and Time values are correct, choose the Accept button to save your changes and return to the Settings screen.

Change Logo

The PHD ULTRA™ displays a descriptive name (termed logo in the application) on the screen. The default value for the logo is “Harvard Apparatus.” This name is editable by the user to allow you to customize the pump for your department/organization.

TO MODIFY THE PUMP LOGO:

1. From the Quick Start or Method Main screen, choose the Settings button.
2. On the Settings screen, choose the Change Logo box to enter the Change Logo screen.
3. Using the onscreen keyboard, type the name that you want to have displayed. The display is limited to 15 characters.

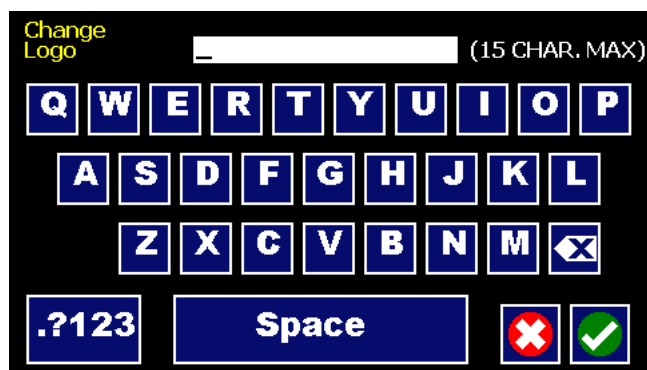

The Change Logo screen.

4. To type numbers or symbols, select the “.?123” button to toggle the keyboard to numbers/symbols mode. To return to letters mode, press the “ABC” button.
5. When finished entering the new name, choose the Accept button to save your changes and return to the Settings screen.



NOTE: To reset the Logo value back to Harvard Apparatus, backspace in the Change Logo text entry box until the field is blank, then choose Accept.

Setting Backlight Level

You can adjust the backlighting level on the PHD ULTRA™ touchscreen to optimize viewing in your specific lighting conditions. On the Settings screen, the Backlight button displays the current setting on the button.

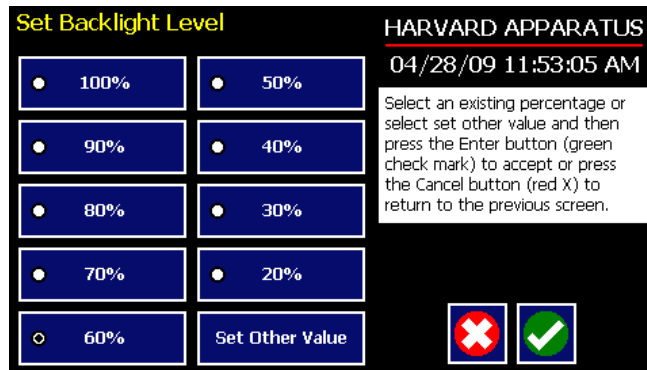

Set Backlight Level screen.

TO MODIFY THE BACKLIGHT LEVEL:

1. From the Quick Start or Method Main screen, choose the Settings button.
2. From the Settings menu, choose the Backlight button to enter the Set Backlight Level screen.
3. Select the desired preset level value or use the Set Other Value button to enter a custom level.
4. If you select Set Other value, enter the desired setting as a percentage value (10-100%) then choose Accept to confirm your setting.
5. When you have selected or entered the desired backlighting value, choose Accept to save your changes and return to the Settings menu.

Setting Pump Address Value

The Pump Address value is used to define a programmable address that can be used in external software applications that will call each PHD ULTRA™ pump individually.

TO MODIFY THE PUMP ADDRESS:

1. From the Quick Start or Method Main screen, choose the Settings button.
2. From the Settings menu, choose the Pump Address button to enter the Set Pump Address screen.
3. Type the desired address value using the onscreen number pad. Valid entries are: 00 - 99.
4. When you have entered the desired address value, choose Accept to save your changes and return to the Settings menu.

Setting the Pump Baud Rate

For attaching the PHD ULTRA™ to an external device using RS-232 or RJ-11 serial communications, you can easily adjust the baud rate to optimize communications.

TO ADJUST THE PUMP BAUD RATE:

1. From the Quick Start or Method Main screen, choose the Settings button.
2. From the Settings menu, choose the Baud Rate button to enter the Set Baud Rate screen.
3. Select the desired preset level value (9600, 19200, 38400, 57600, 115200).

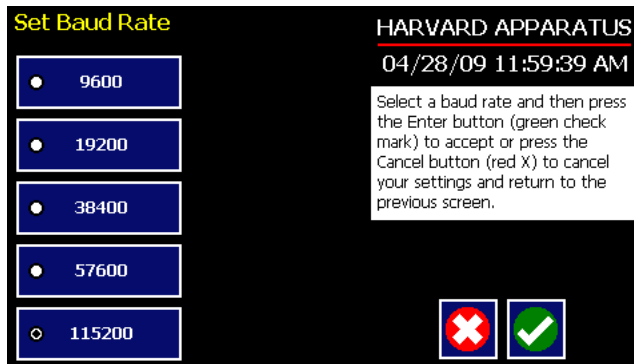

The Set Baud Rate screen with the 115200 rate value selected.

4. When you have selected the desired baud rate, choose Accept to save your changes and return to the Settings menu.

Pump Information

The PHD ULTRA™ monitors usage and provides convenient reminders for periodic maintenance or calibration. You can adjust the settings for the reminders to accommodate your specific operating conditions.

Harvard Apparatus recommends that system calibration checks/adjustments be performed at least once per year on the pump and that lubrication should be performed once every 100 hours of operation.

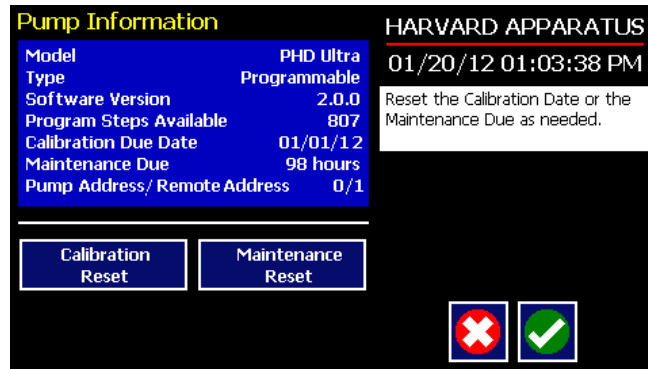

Pump Information screen.

TO RESET THE CALIBRATION AND LUBRICATION DATE AND TIME REMINDERS:

1. From the Quick Start or Method Main screen, choose the Settings button.
2. From the Settings menu, choose the Pump Information button to enter the Calibration screen.
3. Note that the next date for suggested calibration is displayed on this screen at all times.
4. Choose Calibration Reset to set the next suggested Calibration due date based on the current date. Note that calibration is suggested once per year, so choosing Reset will modify the Calibration due date to one year from the current date.
5. The pump will display the total run time since the last reset of the Lubrication timer. To reset the time, choose the Lubrication Reset button.
6. When you are finished, choose Accept to return to the Settings menu.

Power Up Running

The Power Up Running Setting is designed to allow the pump to restart pump operation automatically after a power outage when operating in a “continuous” mode. The Power Up Running selection is only valid under the following conditions:

- When operating in a Quick Start Infuse Only or Withdraw Only method.
- When the pump is running at the time of a power loss.
- When no target Volume/Time is set.

TO SET POWER UP RUNNING:

1. From the Quick Start or Method Main screen, choose the Settings button.
2. From the Settings menu, select the Power Up Running button. The checkbox on the Power Up Running button will be checked to indicate that the function is on. To toggle the function off, select the button again.
3. When the Power Up Running button is set as desired, choose Accept to save your changes and return to the Quick Start or Method Main screen.



NOTE: Counter | Timer information is reset when power resumes. Counter | Timer information prior to power loss is lost.

SYRINGE LOADING

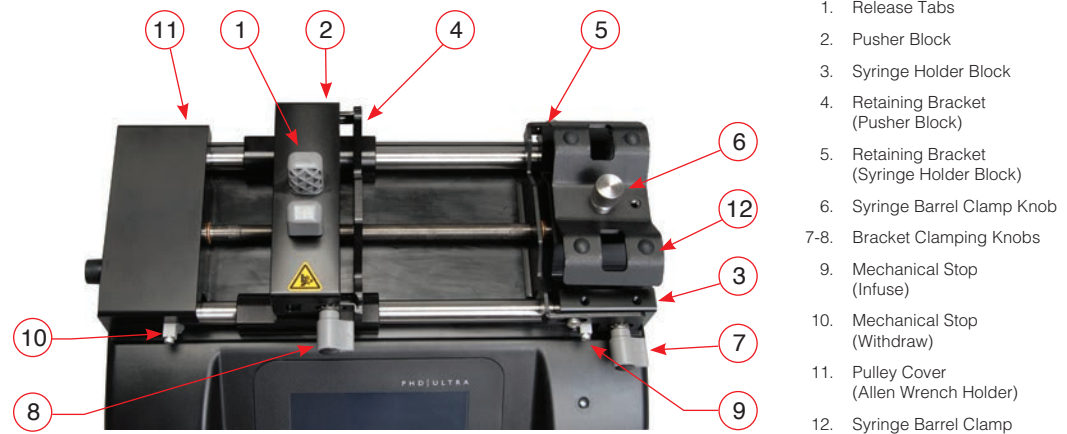

Front view of PHD ULTRA™ showing important controls for syringe loading.

1. Adjust the Pusher Block (2) to the approximate length of the syringe(s) by squeezing the Release Tabs (1) and sliding the Pusher Block (2) into position.
2. Loosen the Retaining Brackets (4,5) on both the Pusher Block (2) and Syringe Holder Block (3) by unscrewing the Bracket Clamping Knobs (7,8). Lift the Syringe Barrel Clamp (12) by unscrewing the Syringe Barrel Clamp Knob (6).
3. Place the syringe(s) on the Syringe Holder Block (3). Ensure that the barrel flange is within the Syringe Holder Block's Retaining Bracket (5) and the plunger flange is within the Pusher Block's Retaining Bracket (4).

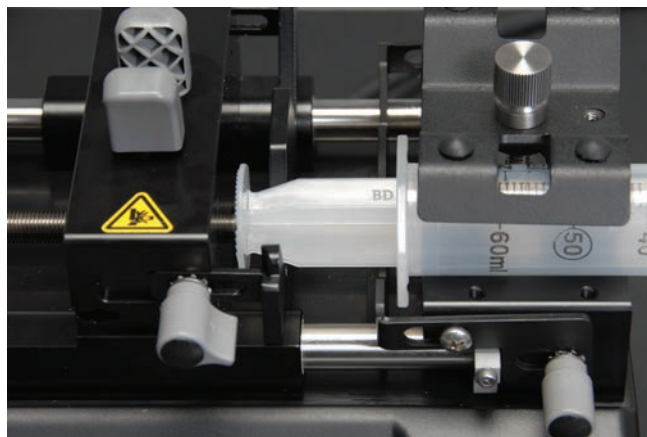

Close-up of syringe positioning with plunger inserted in retaining bracket of pusher block.

4. Lower the Syringe Barrel Clamp (12) by screwing down the Syringe Clamp Knob (6) until the clamp is tight against the syringe barrel.
5. Push the Retaining Brackets (4,5) tightly against the syringe flanges then tighten the retaining brackets using the Bracket Clamping Knobs (7,8).
6. Squeeze the Release Tabs (1) and move the Pusher Block (2) to the right until the syringe plunger is located as far into the syringe as it will travel.
7. Using the Allen Wrench, located in its holder in the rear of the Pulley Cover (11), loosen the Infusion Mechanical Stop (9) and slide it to the left until it is in contact with the Pusher Block (2). Use the Allen Wrench to tighten it in this position.
8. Squeeze the Release Tabs (1) and move the Pusher Block (2) to the left until the plunger is located just to the left of the maximum volume allowable. Use the Allen Wrench to loosen the refill Mechanical Stop (10) and slide it to the right until it is in contact with the Pusher Block (2). Tighten the Withdraw Mechanical Stop (10) and then return the Allen Wrench to its holder (11).

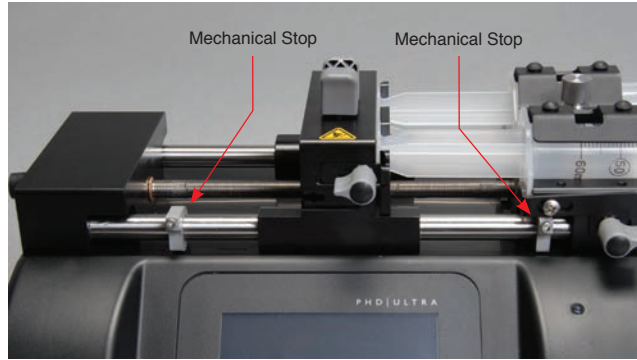

Syringe fully mounted and locked in place. Note mechanical stops set in position to prevent excess travel of pusher block.



CAUTION: Be sure the mechanical stops are positioned properly to prevent the plunger from bottoming out on glass syringes.

Changing the bracket for small (<30ml) vs large (>30ml) syringes:

1. Remove the Syringe Barrel Clamp Assembly by completely unscrewing the Syringe Barrel Clamp Knob.
2. Unscrew and remove the Retaining Nut and slide the clamp bar off the Syringe Barrel Clamp Knob.
3. Flip the bracket over, reassemble the Retaining Nut and screw the assembly back onto the pump.

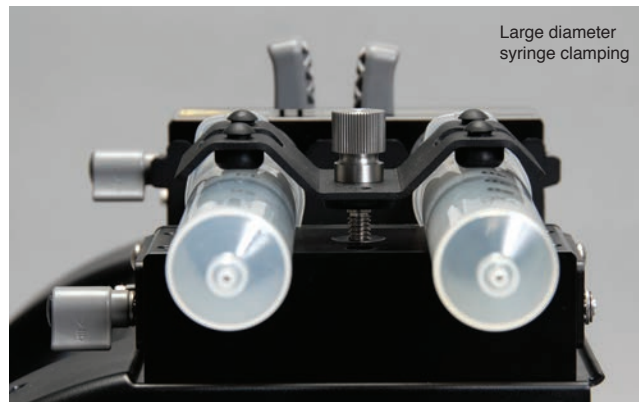

Large vs. small diameter syringe clamping.

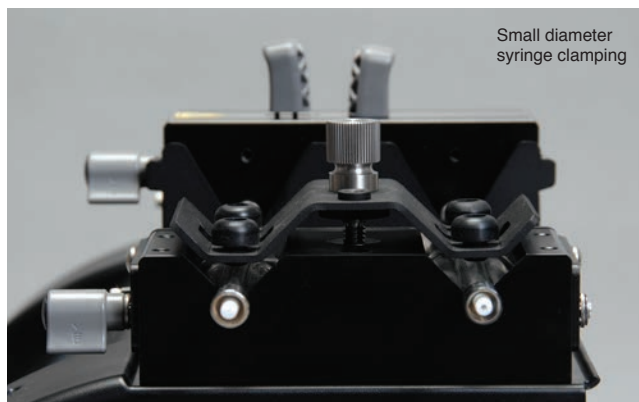

Using The PHD ULTRA™

PUMP OPERATION OVERVIEW

The following diagram provides an overview of basic operation for the PHD ULTRA™:

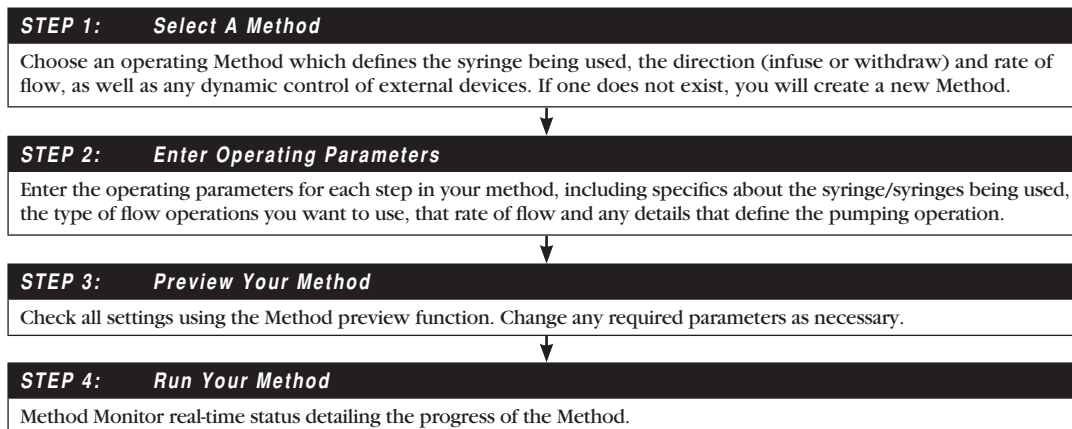

OVERVIEW OF METHODS

To operate the PHD ULTRA™, you will define all the required parameters for withdrawing or infusing liquids through a Pump Control Method. The Pump Control Methods will be commonly referred to as Methods. A Method defines:

- Details about the syringe being used for the application
- How rapidly you will be dispensing or withdrawing the target fluids
- A target volume or target time for the dispensing or withdrawing operation
- The pumping pattern you want to employ (e.g. pump at a continuous rate, in a ramped fashion, using variable rate steps, etc.)
- Outbound triggers to external devices
- Responses to signals from external devices

The PHD ULTRA™ is shipped with a set of pre-installed Methods that are designed to help you to quickly use the pump in common applications. These pre-installed Methods include:

- Quick Start Methods which are simple infuse, withdraw, or combination (infuse and withdraw) Methods that operate in a single step and at a constant rate of flow.
- Preloaded Methods which use more complex Method programming capabilities to describe commonly encountered applications.



NOTE: What Methods are available on your pump depends on the specific model you are using. An Infusion Only model supports only the Quick Start Infuse Method. The Infusion/Withdrawal model supports all Quick Start Methods and one custom Method. The Infusion/Withdrawal Programmable model supports all Methods described in this manual.

In addition, users of the Infusion/Withdrawal Programmable model PHD ULTRA™ can quickly create custom Methods to support more complex dispensing scenarios including:

- Multiple infusions
- Ramped or stepped infusion rates
- Periodic dispensing loops
- Combination infuse and withdraw profiles
- External system control or response to external signals

METHOD TYPES

EZ PRO™ Quick Start

EZ PRO™ Quick Start Methods are designed for simple infusion or withdrawal applications, pumping at a constant flow rate for either a predetermined time period until a preset volume is pumped, or running in continuous operation until stopped. The PHD ULTRA™ is supplied with the following pre-installed Quick Start Methods, depending on the model of PHD ULTRA™ pump you are using:

- **Infuse Only (All Models)**
The Infuse Only Quick Start Method is designed to pump liquids from the syringe at a set flow rate. Users can set a Target Volume or Time period for operation. If no Target Volume or Time value is entered, the pump runs continuously until the Mechanical Stop is reached or the user presses the Method Stop button.
- **Withdraw Only (Infusion/Withdrawal and Infusion/Withdrawal Programmable Models)**
The Withdraw Only Quick Start Method is designed to withdraw liquids into the syringe at a set flow rate. Users can set a Target Volume or Time period for operation. If no Target Volume or Time value is entered, the pump runs continuously until the Mechanical Stop is reached or the user presses the Method Stop button.
- **Infuse/Withdraw Sequence (Infusion/Withdrawal and Infusion/Withdrawal Programmable Models)**
The Infuse/Withdraw Quick Start Method is designed to cycle through an infusion operation followed by a withdraw operation. The user can set separate flow rates for both the infusion and withdrawal sequences. In addition, the user must set a Target Volume for the Method.
- **Withdraw/Infuse Sequence (Infusion/Withdrawal and Infusion/Withdrawal Programmable Models)**
The Withdraw/Infuse Quick Start Method is designed to cycle through a withdraw operation followed by an infusion operation. The user can set separate flow rates for both the withdrawal and infuse sequences. In addition, the user must set a Target Volume for the Method.

EZ PRO™ Preloaded

Preloaded Methods have been designed by Harvard Apparatus engineers to accommodate commonly employed pump control delivery protocols. These applications include infuse, withdraw and combined infuse and withdraw protocols.

Preloaded Methods can be edited on Infusion/Withdrawal and Infusion/Withdrawal Programmable models of the PHD ULTRA™. They are not available on the Infuse Only model.

The Preloaded Methods are continuously updated by Harvard Apparatus Engineers, so the Methods installed on different pumps may vary. For details on specific use of these Methods, refer to the applicable instructions in the Quick Start or User-Defined Methods sections of this manual.

EZ PRO™ User-Defined Methods

User-Defined Methods are created by the user through the application. To create a custom Pump Control Method, you select New Method. After naming the method, select the syringe, then define the infuse or withdraw operations desired using the available Pump Operation Profiles. User-Defined Methods can be stored on the PHD ULTRA™ up to the maximum memory capacity of approximately 800 program steps (programmable model only). The user can manage the library of stored Methods using convenient touchscreen controls.



NOTE: Method Header takes up 1 “step” of memory.

RUNNING THE PUMP

Controlling The Pump

The software provides Fast Forward (Infuse) and Fast Reverse (Withdraw) buttons that can be used to manually control the Pusher block and either Withdraw contents into the syringe or Infuse contents from the syringe.



Use this button to advance the Pusher bar in the reverse (withdraw) direction.



Use this button to advance the Pusher Bar in the forward (infuse) direction.



NOTE: Operating the Fast-Forward and Fast-Reverse will not update the Volume or Time counters in the Method Run screens.

Basic Method Operations

The following operations are common across all Method types:

VIEWING CURRENT METHOD PARAMETERS

As described later in this Guide, PHD ULTRA™ pump operation is controlled by Methods which organize all the commands needed to control the infusion/withdrawal process. The current settings for the pump are displayed in the selection buttons on the Method Main or Quick Start screens.

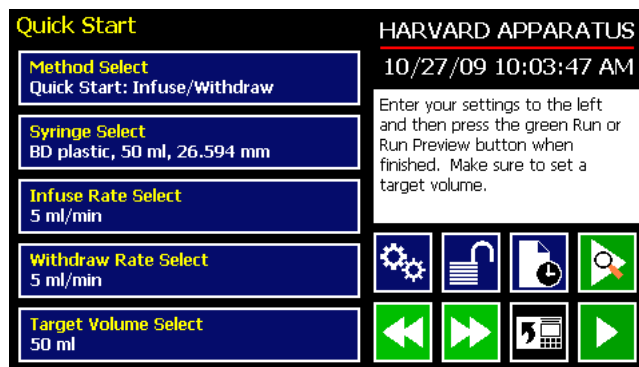

Quick Start screen showing the Infuse/Withdraw Method buttons with current parameters highlighted.

For Preloaded or User-Defined Methods with multiple steps, the Method Main screen displays the first three steps and the last step in the Method operation when all steps do not fit on the screen. In the following sample screen, the first three steps (Delay, Ramp, Constant Rate) are displayed in one box/button, and the last step (Ramp) is displayed beneath them.

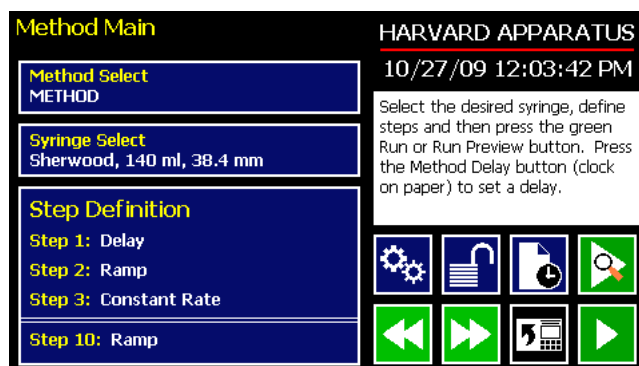

Method Main screen showing a sample Method with 10 steps.

SYRINGE SELECTION

In order to accurately control the flow rate or volume delivery of the pump, the PHD ULTRA™ requires that each method include accurate setting of the syringe diameter and volume. All Methods (Quick Start, Preloaded, User-Defined) require a syringe definition, either by selecting from the installed syringe specifications list or by defining a new (Custom) syringe in the application.

The built-in Syringe Lookup Table provides a convenient lookup function that allows users to select from a wide variety of syringes from major manufacturers, including: Air-Tite, Becton Dickinson, Hamilton, Harvard Apparatus, Cadence Science, SGE Scientific Glass Engineering, Sherwood – Monoject, and Terumo. This Guide also includes a reference table of major syringe diameter and volume parameters in Appendix A: Syringe Volume/Diameter Reference Table.

The following parameters must be set for every syringe selection:

- Syringe Diameter: mm
- Syringe Volume: ml or µl



WARNING: When using low-volume, small diameter syringes or pumping high-viscosity liquids, you should adjust the Force value in the Settings menu to avoid accidental damage to the syringe.



NOTE: For Master/Satellite configurations, changing diameter at the Master will change the diameter at all satellites.

TO SELECT A SYRINGE USING THE SYRINGE LOOKUP FUNCTION:

1. From the Quick Start or Method Main screen, choose the Syringe Select button.

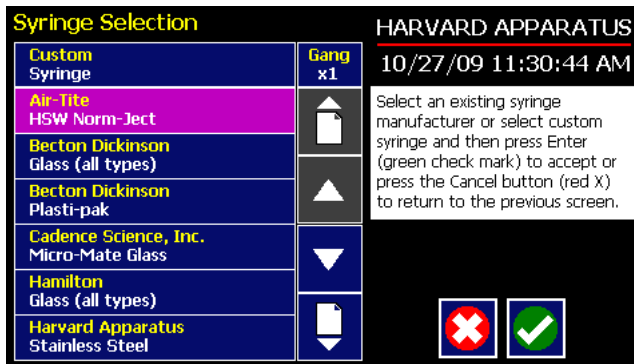

Syringe Selection screen with currently selected syringe.

2. From the Syringe Selection menu, double tap the Manufacturer/Model button for the desired syringe to enter the Syringe Size Selection screen.

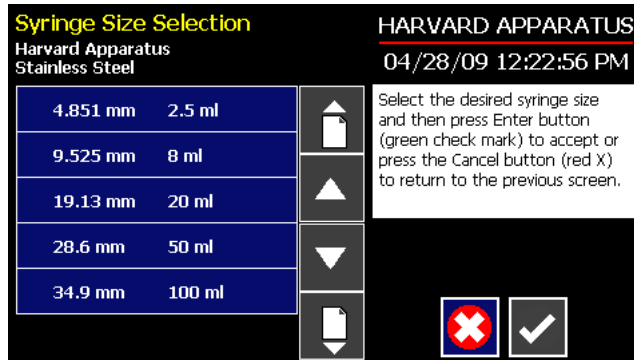

Syringe Size Selection screen showing barrel dimensions and syringe capacity.

3. Double tap the dimensions/capacity button for the syringe you will be using.

TO CREATE A CUSTOM SYRINGE OPTION:

1. From the Quick Start or Method Main screen, choose the Syringe Select button.
2. From the Syringe Selection menu, double tap the Custom Syringe option at the top of the syringe selection menu.
3. On the Syringe Dimension Entry screen, the Diameter (mm) entry box should be highlighted by default. If it is not, choose the Diameter (mm) button.

Syringe Dimension Entry screen.

4. Enter the diameter of your syringe using the keypad.
5. Choose the Volume button and enter the total volume of your syringe.
6. If the Volume unit of measure is not correct, choose the Unit of Measure button.
7. On the Units Selections screen, select the Units button appropriate to your syringe, then choose Accept. You are automatically returned to the Syringe Dimension Entry screen.
8. When all parameter entries are correct, choose the Accept button to return to the Quick Start or Method Main screen.



NOTE: Each custom method is capable of using and storing a different custom syringe, but these custom syringe selections are not saved anywhere that can be recalled.



CAUTION: Be sure to lower the force value when using glass syringes.



CAUTION: See “Setting Force Limits” section if using Master/Satellite configuration.

Gang Feature

The Gang feature allows multiple syringes to be combined into one common output.

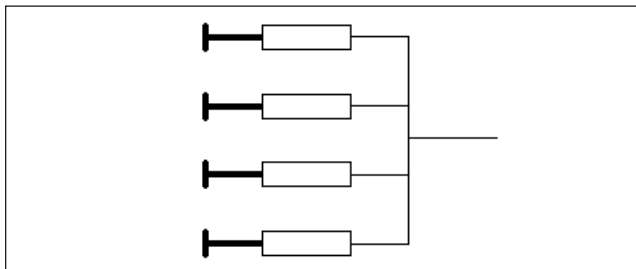

Multiple syringes combined into a common output.

1. From the Configuration screen, choose syringe select.

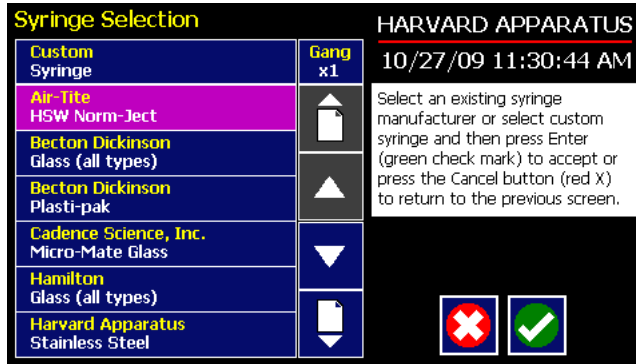

Syringe Selection Screen showing Gang button.

2. Choose the Gang button to enter the Set Syringe Count screen.

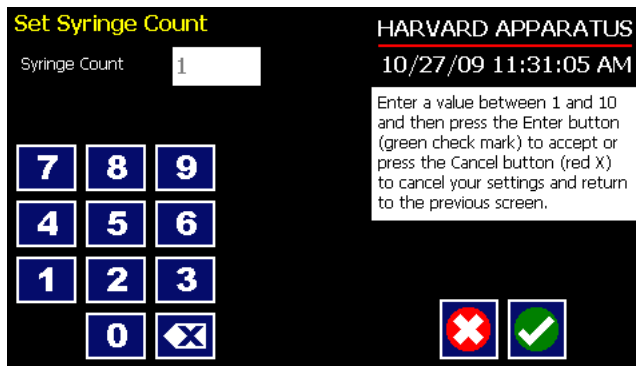

Gang count entry screen.

3. Enter the number of syringes being used then press the Accept button.



Quick Start screen showing gang number equal to 4 syringes

4. Select your syringe manufacturer and size as previously instructed.



NOTE: Possible flow rates and target volumes will change depending on the number of syringes in the gang. Previously entered parameters may need to be reset.

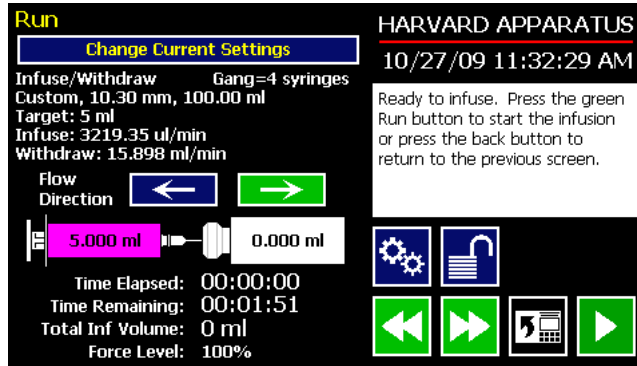

Run screen showing
Gang = 4 syringes.



NOTE: If syringe Gang number = 1, the value will not appear on any screen. Only displays for Gang \geq 2.

Controlling The Pump Using A Stored Method

The PHD ULTRA™ Methods contain the detailed parameters required to control the pump for infuse or withdraw operation. This section describes the basic operation of the pump using a stored Method.

SELECTING A METHOD

- From either the Quick Start or the Method Main screen, choose Method Select to access the Method Selection screen.



Method Selection screen
showing a listing of Methods
in an Infusion/Withdrawal
Programmable model PHD
ULTRA™ pump.

- From the list of available Methods, double tap the desired Method. If the Method is not displayed in the list, you can use the Scroll Up/Down buttons or Page Up/Down buttons to advance the list up/down as needed. Be sure to confirm your selection by pressing the button containing the Method name a second time, or choosing Accept. You will be returned to the Quick Start or Method Main screen with the Method Select button now displaying the desired Method.

CONFIRMING METHOD PARAMETERS

- With the desired Method displayed in the Method Select button, verify that the proper syringe information is set. The currently defined syringe settings are displayed in the Syringe Select button. If the syringe information is not correct, follow the procedure for selecting a syringe defined previously in the Syringe Selection section of this manual.
- Verify that the Rate and Volume/Time settings are properly set. If changes are required, refer to the procedures described later in the Quick Start Method Variables section of this manual.
- With all Method parameters set as desired, check to see if the Run button is active.
- If any required parameters are not set or are improperly set (e.g. a value is out-of-range based on syringe selection or other condition), the Run button will be inactive (grayed out). You must have all required parameters validly defined before the Method can be started.

PREVIEW THE METHOD

7. To Preview a Method, press the Method Preview button to enter the Run (Quick Start Methods) or Method Run (Preloaded and User-Defined Methods) screen.

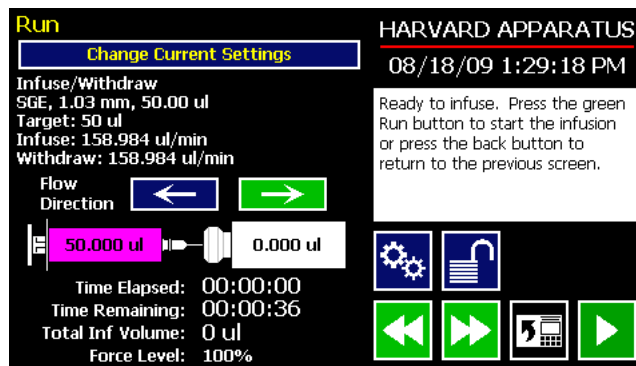

Quick Start Run screen for a Infuse/Withdraw Method.

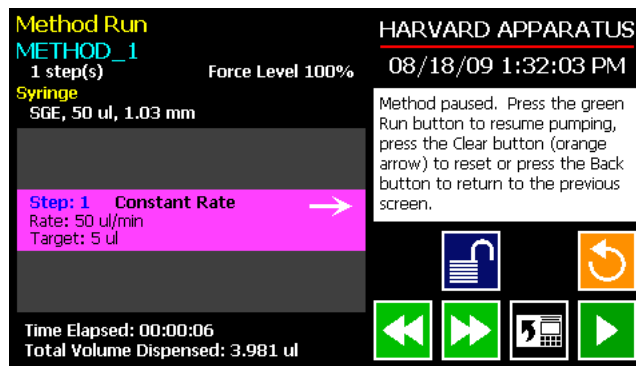

Method Run screen for Preloaded and User-Defined Methods.

The Run/Method Run screens contain a summary of the operating parameters as described below:

Quick Start Run Screen

- Method type
- Syringe information
- Target Volume
- Summary of Infuse and Withdraw rates, as applicable
- Initial flow direction
- Total time for the Method
- Force Level setting

Preloaded/User-Defined Method Run Screen

- Method name
 - Total number of steps in the Method
 - Syringe information
 - Summary flow parameters for the previous step, current step, and next step to be performed in the method.
 - Force level settings
8. To change any of the Method parameters, choose the Back button on either the Run or Method Run screen, or choose the Change Current Settings button on the Quick Start Run screen.

RUN THE METHOD

- To start a pump Method, choose the Run button. While a Method is running, the Pump Run LED will be lit. The Run/Method Run screen will provide real-time feedback on the progress of the Method operation as shown below:

Quick Start Method	Preloaded/User-Defined Methods
<ul style="list-style-type: none"> Current flow direction (infuse/withdraw) Volume withdrawn/infused and volume remaining Time elapsed Time remaining Total volume infused 	<ul style="list-style-type: none"> Total time elapsed for Method Total Volume Infused across all Method steps Previous Step Information Next Step Information

Quick Start Method Run screen after a Method has been started.

User Defined Method Run Screen after a method has been started.

10. To Pause a Method during operation, choose the Method Stop button.

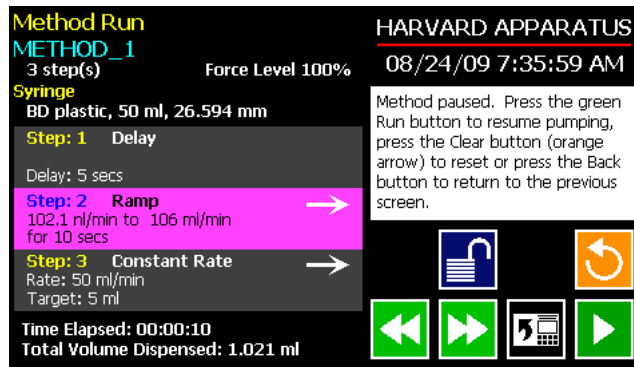

Method Run screen with a User-Defined Method paused on Step 2. Note the currently active Step is highlighted.

11. To Resume a Method that is paused, choose the Run button.
12. To Cancel a Method that is paused, choose the Clear button. The Method is reset to its initial parameters when Clear is pressed.
13. Upon completion of a Method operation, choose the Re-Run button to clear all counters and timers and repeat the Method.

USING AN EZ PRO™ QUICK START METHOD

Quick Start Methods are designed to help you quickly and conveniently use the PHD ULTRA™ for simple infusion or withdrawal applications. Each Quick Start Method requires a minimal number of user entries to operate.

Basic Operation

The following flow diagram describes the use of a Quick Start Method:

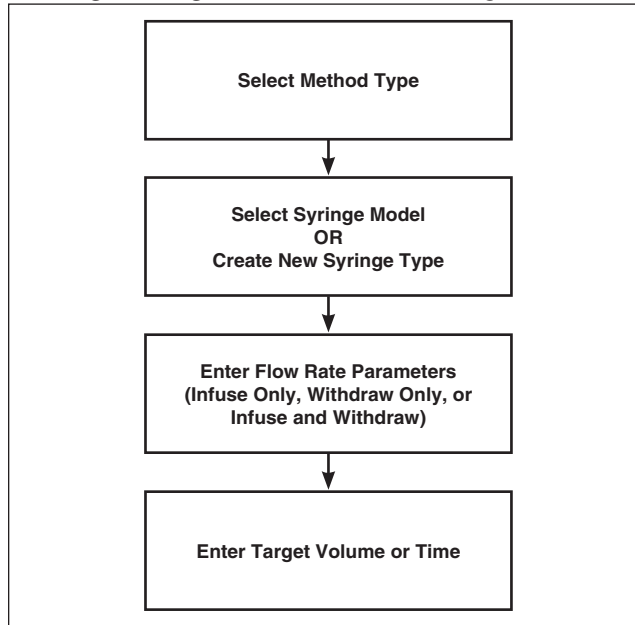

Quick Start Method operation flow diagram.

All the required parameter options are accessed from the Quick Start screen. The following sections provide a detailed overview of operation for a Quick Start Method.

STEP-BY-STEP OPERATION EXAMPLE: QUICK START INFUSE/WITHDRAW METHOD

The following procedure describes operation using the Quick Start Infuse/Withdraw Method.



Infuse/Withdraw Quick Start Method screen.

1. From the Quick Start screen, the Infuse/Withdraw Quick Start Method should be displayed in the Method Select button. If that Method is not displayed, select the correct Method using the procedure outlined in Running The Pump.
2. Choose the Syringe Select button to enter the Syringe Selection screen.
3. Follow the instructions in the Syringe Selection section of this Guide to complete the selection of a syringe from the built-in Syringe Lookup Table or to create a new syringe. When finished, choose the Accept button to save your changes, or choose the Cancel button to cancel your changes, and return to the Quick Start screen.

4. Choose the Infuse Rate Select button to access the Set Infuse and Withdraw Rates screen.
5. Enter the required parameters on the Set Infuse and Withdraw Rates screen. Details on setting the Infuse and Withdraw Rates are provided in the Quick Start Method Variables section of this Guide. When finished, choose the Accept button to save your changes, or choose the Cancel button to cancel your changes, and return to the Quick Start screen.
6. Choose the Target Volume Select button to enter the Set Target Volume screen.
7. Enter the required data on the Set Target Volume screen as described in the Quick Start Method Variables section of this Guide.

Quick Start Method Variables

INFUSE RATE SELECT/WITHDRAW RATE SELECT

The Quick Start Infuse Rate and Withdraw Rate Select functions define the rate of pumping while infusing or withdrawing liquids respectively. The two functions are controlled identically, so we have described the operation here only once.

When adjusting the Infuse Rate, you can set the rate in ml, μ l, nl or pl units of volume and use sec, min or hr as the units of time. The system automatically calculates a minimum and maximum flow rate based on the syringe selected or custom-defined. The min/max values are made available as button selection options on the Set Infuse and Withdraw Rate screens.



NOTE: The following instructions describe setting the Infuse Rate. The instructions are the same for Withdraw Rate. On an Infuse/Withdraw combination Method, you can set both rates on a single screen by toggling between the two rate options using the Infuse Rate or Withdraw Rate buttons at the top of the screen.

Set Infuse Rate screen in a Quick Start Infuse Only Method.

Set Infuse and Withdraw Rates in a Quick Start Infuse/Withdraw combined Method.

TO SET THE INFUSE RATE (INFUSE ONLY METHOD):

1. From the Quick Start or Method Main screen, choose the Infuse Rate Select button.
2. On the Set Infuse Rate screen, enter the desired rate value using the keypad or select the Minimum or Maximum Rate button.
3. If the Units of Rate are not correct for your application, choose the Units button.
4. On the Units Selection screen, select the unit of measure (ml, μ l, nl or pl) and the unit of time (sec, min, hr) as appropriate, then choose Accept to confirm your selections.
5. When all parameters are correctly set on the Set Infuse Rate screen, choose Accept to confirm your settings and return to the Quick Start or Method Main screen.

TARGET VOLUME/TIME SELECT

The Target Volume/Time Select function is used to control how long the PHD ULTRA™ will operate at the set flow rate. The run time can be controlled by either pumping to a total volume pumped or the total length of time pumped. Quick Start single function Methods (Infuse Only or Withdraw Only) permit controlling the pump for either target time or volume. Quick Start composite Methods (Infuse/Withdraw or Withdraw/Infuse) only permit control by Target Volume.

When setting this parameter, you can choose between the following units of volume (ml, μ l, nl or pl) and the following units of time(sec, h:min:sec). The system automatically calculates a Maximum Volume value based on the syringe selected or custom defined for the Method.

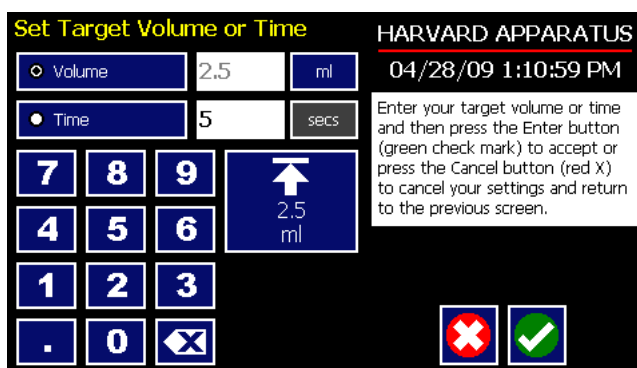

Set Target Volume/Time for setting pumping duration in a Quick Start Infuse Only Method.



NOTE: For Infuse/Withdraw Methods, this parameter only permits the setting of the Target Volume parameter.

TO SET THE TARGET VOLUME OR TIME:

1. From the Quick Start screen, choose the Target Volume/Time Select button.
2. On the Set Target Volume or Time screen, select the Volume or Time button, as desired.
3. Enter the desired value using the keypad, or select the Maximum Volume button.
4. If the Units of Volume/Time are not correct for your application, choose the Units button to the right of the parameter entry box. For the Units of Volume, this choice takes you to the Units Selection screen. For the Units of Time option, this choice will toggle the button between sec (seconds) and h:m:s (hours:minutes:seconds). To use the h:m:s option, enter your time value in hours, minutes and seconds, separating each value with a colon.
5. If you are changing the Units of Volume, on the Units Selection screen, select the unit of measure (ml, μ l, nl or pl) as appropriate, then choose Accept to confirm your selection.
6. When all parameters are correctly set on the Set Target Volume or Time screen, choose Accept to confirm your settings and return to the Quick Start screen.

USING AN EZ PRO™ PRELOADED/USER-DEFINED METHOD

The Preloaded Methods and User-defined Methods each use the PHD ULTRA™'s integrated tools that guide users through creation/editing of a custom Pump Control Method. Pump Control Methods consist of the following set of operating parameters:

- The Method Name
- Syringe Information
- The set of Pump Operation Profile steps that describe how the pump will control the flow of material for infusion or withdrawal operations
- Any additional commands to control the execution of the steps
- Any input/output (I/O) triggers/responses used to control external devices or respond to input signals from external devices.

Both the Preloaded and User-Defined Methods offer the user the flexibility to apply pumping profiles other than continuous rate infusion/withdrawal. The PHD ULTRA™ offers a menu of advanced pumping profiles, including:

- Constant Rate: a single continuous rate of flow
- Ramped Rate: a linearly changing flow rate between a starting and ending flow rate
- Stepped Rate: an evenly-stepped, changing flow rate between a starting and ending flow rate
- Pulsed Flow: an oscillating flow rate varying between a starting and a target rate
- Bolus Delivery: an infusion operation to occur for a specified volume and time. The Infusion Rate is automatically calculated
- Concentration Infusion: a measured flow rate based on delivery of a specific dosage to a recipient based on the recipient's weight
- Gradient: Combined flow streams from multiple pumps into a common output stream.
- Autofill Cycling: continuous infuse/withdraw or withdraw/infuse operation.

In addition, you have access to a variety of Advanced Options that allow the PHD ULTRA™ to repeat, loop back or jump forward in a Method, as well as send signals to external devices or react to signals received from external devices. This package of pumping profiles and commands provides users with an extremely broad array of applications that can be easily configured without the use of complex external programming.

The Preloaded Methods provide a starting set of Methods that define some commonly used application protocols. These Methods can be edited and saved under a new name, or simply edited to fit your specific requirements. Creating a new User-Defined Method permits you to leverage all the options available on the PHD ULTRA™.

Preloaded/User-Defined Method Workflow

The following flow diagram describes the use of an existing Preloaded or user-Defined Method:

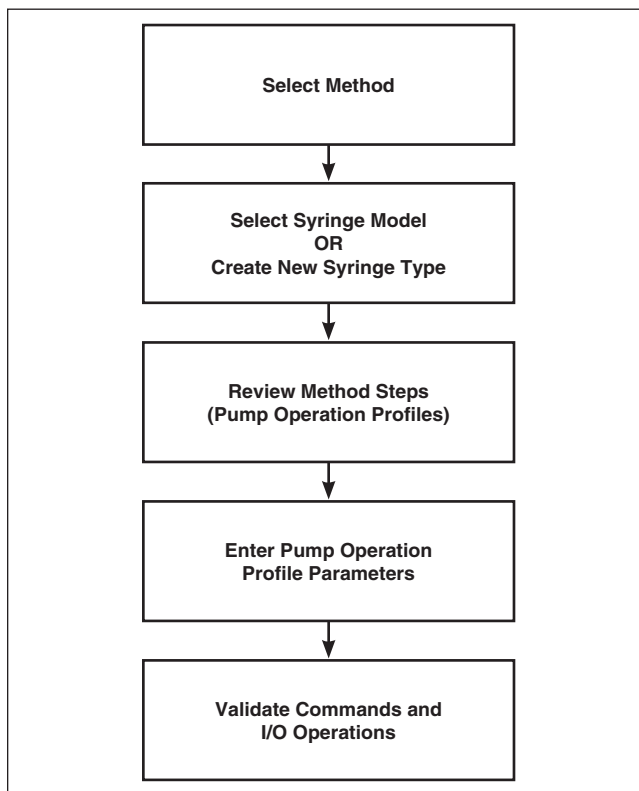

*Preloaded/User-Defined
Method workflow.*

As with Quick Start Methods, the EZ PRO™ software provides the user with a variety of prompts and warnings to help guide the setup of methods. For example, if a pump Method incorporates steps that exceed the capacity of the defined syringe, the system will prompt you that parameters are out-of-range. The system also prompts users if required values are not entered.



NOTE: The pump will check the validity of parameters entered for each Step in the Method, but will not review the Method in its entirety to verify that it is logical and can be fully executed.

STEP-BY-STEP OPERATION EXAMPLE: USING A PRELOADED OR USER-DEFINED METHOD

The following steps describe operation using a Preloaded or User-Defined Method.

In the following description, we are assuming the use of a Method that is already saved on the PHD ULTRA™. Note that if you make any changes to the Method's operating parameters and choose Accept on the page where the changes are made, the changes automatically become part of the stored Method for future use.

1. From the Method Main screen, the Method you wish to use should be displayed in the Method Select button. If the Method is not displayed, select the correct Method using the procedure outlined in Running The Pump.
2. Choose the Syringe Select button to enter the Syringe Selection screen.
3. Follow the instructions in the Syringe Selection section of this Guide to complete the selection of a syringe from the built-in Syringe Lookup Table, or to create a new syringe. When finished, choose the Accept button to save your changes, or choose the Cancel button to cancel your changes, and return to the Method Main screen.
4. Review the Pump Operation Profile Steps described in the Step Definition button. Note that the software will display the first three Steps in the Method in the main button area. If the Method uses more than three Steps, the last Step in the Method will be displayed in the box beneath the Step Definition button.
5. To review the Method Steps in detail or to update/modify any of the stored Pump Operation Profile Parameters, choose the Step Definition button to enter the Method Steps Summary Screen. The name of the Method is listed at the top of the screen, and the complete list of Steps is listed in a series of buttons beneath the Method Name.

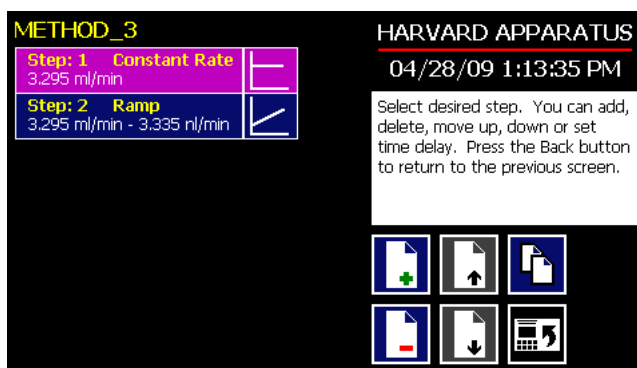

Step Definition Screen showing the list of Steps currently defined for the Method.

6. To review details for any individual Step in the Method, select the Step you wish to review, then press the Step button again to enter the Step Definition screen for that Step.



NOTE: To edit the existing profile, press the left side of the step button. To replace this step with a new profile, press the right side of the button (on the picture).

7. To edit the parameters for any Pump Operation Profile, follow the instructions supplied in the applicable Pump Operation Profile description contained in the Setting Method Parameters section later in this Guide.
8. To return to the Method Steps Summary screen when finished reviewing or editing the Step parameter details, choose the Accept button to save your changes or choose the Cancel button to cancel any changes you made.
9. When you are finished reviewing the operating details for all Steps, choose the Back button to return to the Method Main screen.
10. To preview the Method, choose the Preview button, or to run the Method, choose the Run button.

Setting A Time Delay For Method Operation

You can set the PHD ULTRA™ to run a Method at a specific date and time in the future. This delayed run function allows you to set up all the parameters for operation, then have the pump start unattended at the required time.

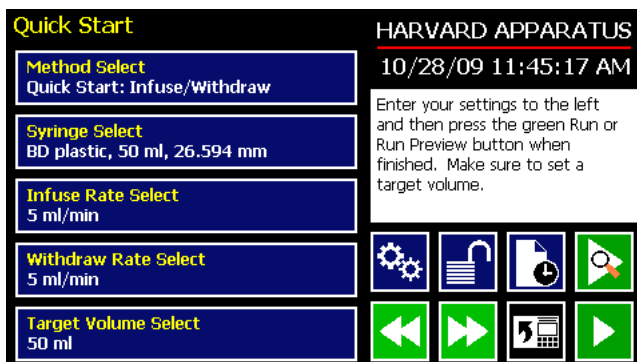

Set Delay Parameters button on Quick Start screen.

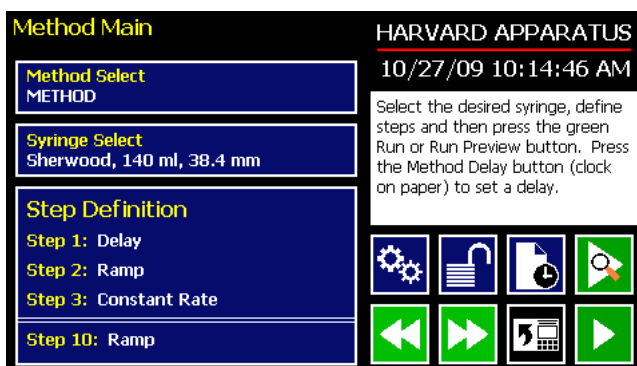

Set Delay Parameters button on Method screen.

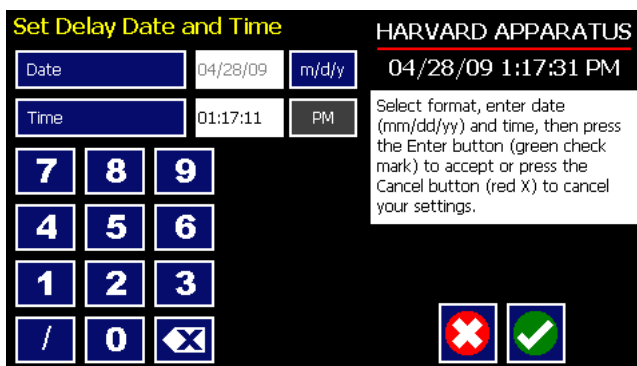

Set Delay Date and Time screen.

SETTING A TIME DELAY FOR METHOD OPERATION

1. From the Method Main or Quickstart configuration screen, choose the Set Delay Parameters button to enter the Set Delay Date and Time screen.
2. To enter the date, select the Date button and type the desired date using the onscreen number pad. Select the Date Format button to toggle between Month/Day/Year (m/d/y), Day/Month/Year (d/m/y) and Year/Month/Day (y/m/d) formats. Enter your values in two-digit format for each value. For example, April 3, 2009 would be entered as 04/03/09 in m/d/y format.
3. To enter the time, select the Time button and type the desired time using the onscreen number pad. Select the Time Period button to toggle between AM/PM and 24-hours settings. Time should be entered using hours:minutes:seconds (hh:mm:ss).

- A
4. When the desired values are entered, choose the Accept button to save your Changes and return to the Method Main screen. When a Time Delay value is active, the Time Delay Parameters button is displayed in Red on the screen to alert the user that a delay has been set.
5. Press the Run button to activate the Delay.

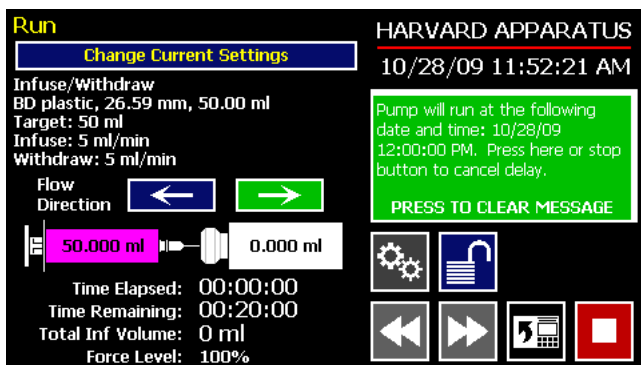

Quick Start method with a Time Delay set.

CREATING AN EZ PRO™ NEW METHOD

If none of the Methods stored on the PHD ULTRA™ match your requirements, you can create a new Method and store the Method for use. The following flow diagram outlines the basic steps you will follow to create a new Method:

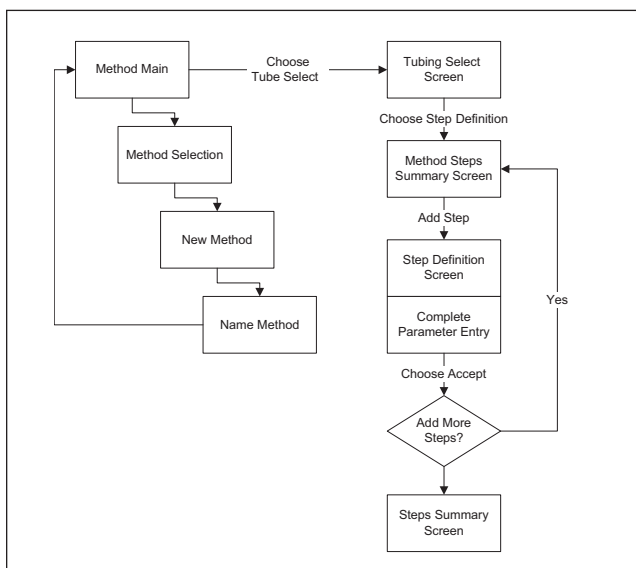

New User-Defined Method creation workflow.

TO CREATE A NEW USER-DEFINED METHOD

1. From the Method Main or Quick Start screen, choose the Method Select button to enter the Method Selection screen.
2. Select New Method then choose Accept or press New Method again.

- On the Method Name screen, type the name of your Method (up to 15 characters) using the onscreen keyboard. Choose the Symbols/Numbers button (.?123) to display the list of available numbers and symbols that can be included in the Method Name. To switch the keyboard back to letters mode, choose the Letters button (ABC).

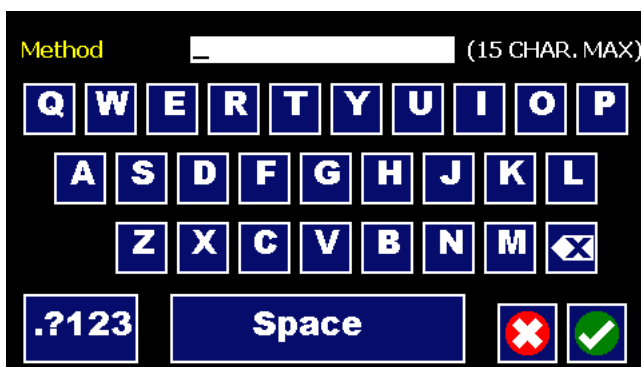

New Method Name Entry screen showing letter keys. To view numbers/symbols, choose the .?123 button in the lower left corner.

- When you have entered the desired name for your Method, choose the Accept button to return to the Method Main screen. Your new Method will now be listed in the Method Select button.
- Choose the Syringe Select button and complete the selection of the syringe by following the procedure outlined previously in the Syringe Selection section of this Guide.
- To begin creating Pump Operation Profile Steps, choose the Step Definition button to enter the Method Steps Summary screen.
- To add a Step to your Method, choose the Add Step button to access the Select Profile Menu screen. The available options include:

a. Constant Rate	c. Stepped	e. Bolus	g. Gradient	i. Advanced Options
b. Ramp	d. Pulse	f. Concentration	h. Autofill	

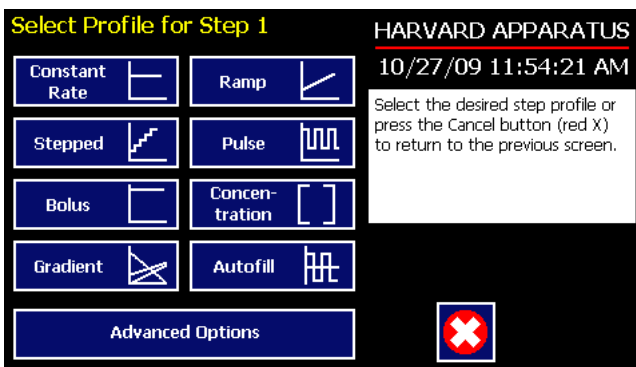

Method Steps Profile Menu screen.

- Choose the Method Step type that you want to add to the Method. If you choose a pumping profile (e.g. Constant Rate, Ramp, etc.) you will be taken to the Step Definition screen for the selected Method. If you choose Advanced Options, you will be taken to the Select Advanced Options screen.
- Complete the parameter entry applicable to the selected Pump Operation Profile, follow the detailed instructions supplied in the Pump Operation Profiles (Preloaded and User-Defined Methods) section later in this Guide. If you selected Advanced Options, follow the instructions supplied in the Incorporating Advanced Options Into a Method section later in this manual.



NOTE: When setting a Target Time for a method step, the minimum length is 0.5 seconds.

10. When you have completed all parameter entries on the Step Definition screen or completed the required entries for Advanced Options, choose the Accept button to save your changes and return to the Method Steps Summary screen.
11. Repeat items 7-10 in this procedure to include additional Steps in the Method.



NOTE: When adding a Step to a Method, the Step is added after the currently selected Step (i.e. the Step that is highlighted in purple)

12. When you are done adding all required Steps to the Method, choose the Back button to return to the Method Main screen.

Modifying a Preloaded/User-Defined Method

Once you have created a Method or have reviewed a Preloaded Method, you may have a need to modify the structure of the Method (i.e. the types of Steps and Commands included, not just changes in the operating parameters for a specific Step. The following procedures will help you to efficiently modify a stored Method.

CHANGING THE ORDER OF STEPS IN A METHOD

1. From the Method Main screen, choose the Step Definition button to enter the Method Steps Summary screen.
2. Highlight (select with a single touch) the Step for which you want to change the order.
3. Choose the Move Step Up or Move Step Down button, as required, to move the Step into the position that you want it executed.



NOTE: If there are Method Commands (e.g. Go To) that link to the Step, moving Steps can result in unexpected results as the Command may be linked to the Step number. You should always recheck all Method Commands after adding, deleting or moving Steps in a previously created Method.

DELETING A STEP FROM A METHOD

1. From the Method Main screen, choose the Step Definition button to enter the Method Steps Summary screen.
2. Highlight (select with a single touch) the Step that you want to delete.
3. Choose the Delete Step button. The application will display a warning message in the Message Area asking you to confirm your deletion request.

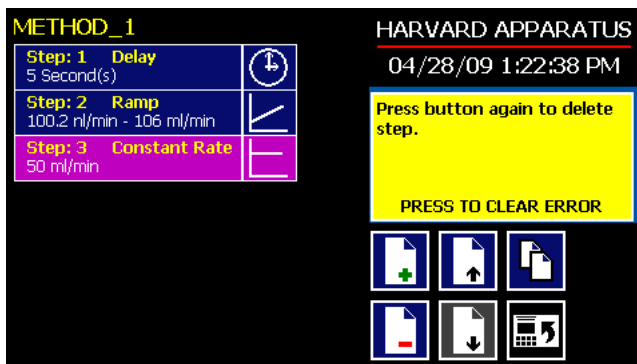

Delete Method Step showing confirmation message on the screen.

4. To confirm the deletion, choose the Delete Step button again. The Step is removed and you are returned to the Method Steps Summary screen.

DUPLICATE A STEP IN A METHOD

Use this procedure to insert a copy of a Step with all its associated parameter settings into a Method.

1. From the Method Main screen, choose the Step Definition button to enter the Method Steps Summary screen.
2. Highlight (select with a single touch) the Step that you want to copy.
3. Choose the Duplicate Step button. The application will insert a copy of the highlighted Step to the bottom of the Method (i.e. the last Step in the Method).

DEFINING METHOD STEP PARAMETERS

This section of the User Guide describes each of the available functions available for use in PHD ULTRA™ Preloaded and User-Defined Methods. The information in this section is designed to help you set the individual parameter values in each of the Method Step options and to properly use the Advanced Options commands.

The information that follows is organized into two sections:

- Pump Operation Profiles
- Advanced Options (Commands and I/O)

Pump Operation Profiles

The PHD ULTRA™ Preloaded Methods and all User-Defined Methods use Pump Operation Profiles as part of the Methods controlling the pump. These profiles are combined with a syringe selection and any Commands or Input/Output triggers to create a complete Method. The following sections describe each profile along with instructions for setting up the profile. The following Pump Operation Profiles are available on the PHD ULTRA™:

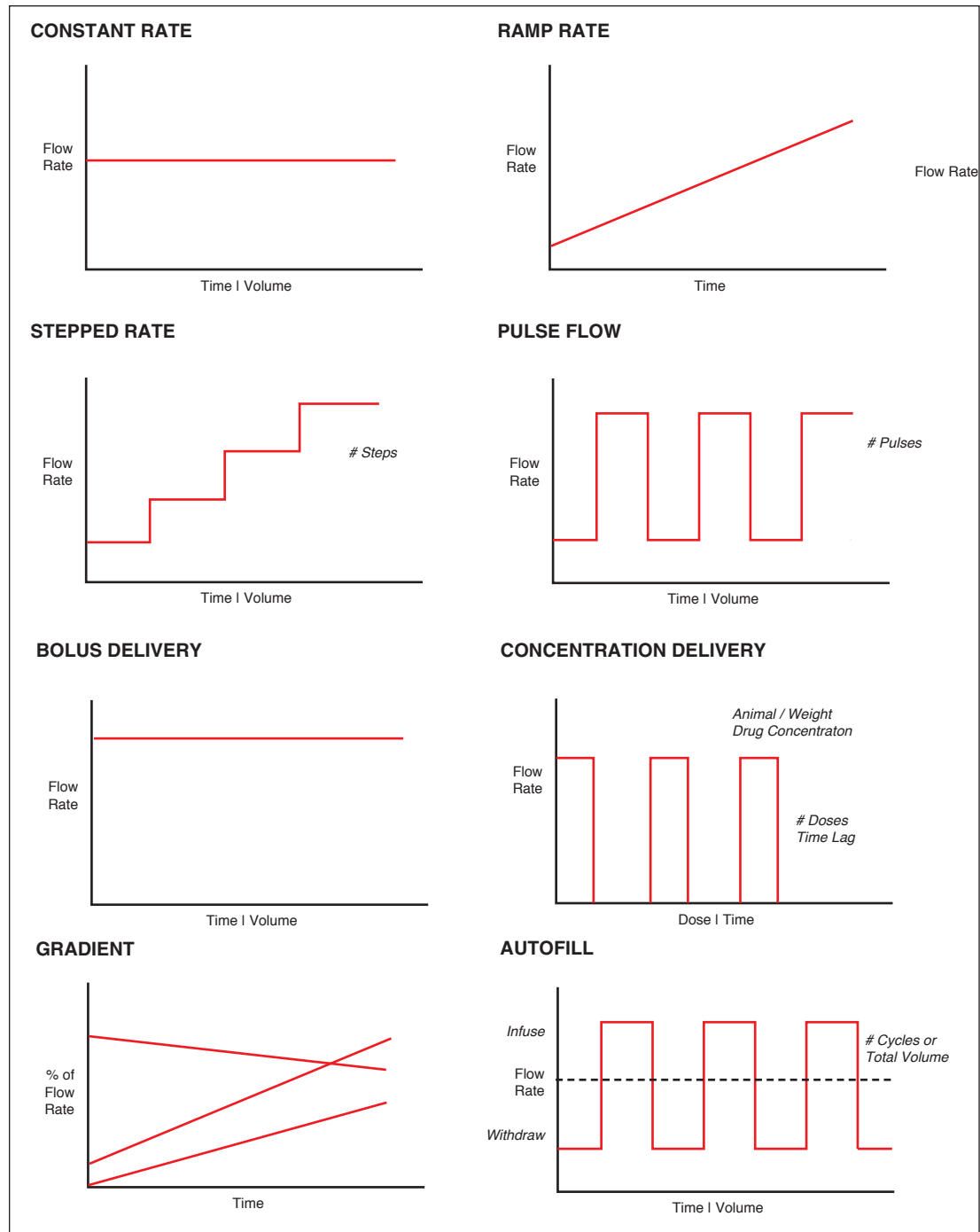

Pump Operation Profiles available on the PHD ULTRA™.

CONSTANT RATE PROFILE

The Constant Rate profile is used to run the pump at a defined flow rate and for a specific pumping mode (infuse or withdraw) up to a target volume or for a defined time period.

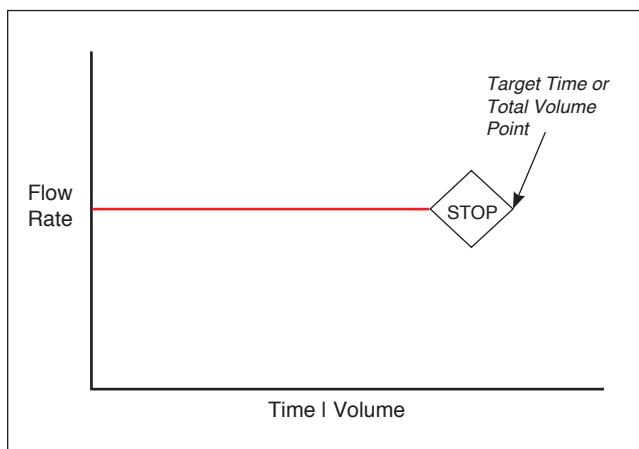

Constant Rate Pump Operation Profile.

When creating or editing a Constant Rate profile, you will define three primary operating parameters:

- The Flow Mode defining the direction of flow: infuse or withdraw
- The Flow Rate to define the rate of uptake or dispensing
- The Target Volume or Target Time that determine how long the pump will operate at the set rate

When creating or editing a Constant Rate profile, you can set the rate in ml, μ l, nl or pl units of volume using sec, min or hr as the units of time. The system automatically calculates a minimum and maximum flow rate based on the syringe selected or custom-defined. The min/max values are made available as button selection options on the Set Infuse and Withdraw Rate screens.

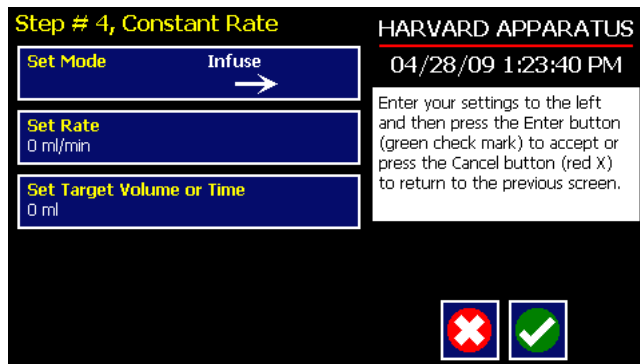

Step Definition Screen for a Constant Rate Profile.

TO SET UP/EDIT A CONSTANT RATE PROFILE:

1. From the Step Definition screen for a Constant Rate profile, choose the Set Mode button to toggle the Flow Mode between Infuse and Withdraw operation.
2. Choose the Set Rate button to enter the Set Rate screen.
3. Enter the flow rate value desired using the keypad or select the Minimum Rate or Maximum Rate button.
4. If the Units of Rate are not correct for your application, choose the Units button.
5. On the Units Selection screen, select the unit of measure (ml, μ l, nl or pl) and the unit of time (sec, min, hr) as appropriate, then choose Accept to confirm your selections.
6. When all parameters are correctly set on the Set Rate screen, choose Accept to confirm your settings and return to Step Definition screen.

7. Choose the Set Target Volume or Time button to enter the Set Volume or Time screen.
8. On the Set Volume or Time screen, select the Volume or Time button, as desired.
9. Enter the desired value using the keypad, or select the Maximum Volume button.
10. If the Units of Volume/Time are not correct for your application, choose the Units button to the right of the parameter entry box. For the Units of Volume, this choice takes you to the Units Selection screen. For the Units of Time option, this choice will toggle the button between sec (seconds) and h:m:s (hours:minutes:seconds). To use the h:m:s option, enter your time value in hours, minutes and seconds, separating each value with a colon.
11. If you are changing the Units of Volume, on the Units Selection screen, select the unit of measure (ml, µl, nl or pl) as appropriate, then choose Accept to confirm your selection.
12. When all parameters are correctly set on the Set Target Volume or Time screen, choose Accept to confirm your settings and return to the Step Definition screen.

RAMP PROFILE

The Ramp Rate profile is used to create a linearly increasing or decreasing flow rate for a single pumping mode (infuse or withdraw) over the course of a defined time period.

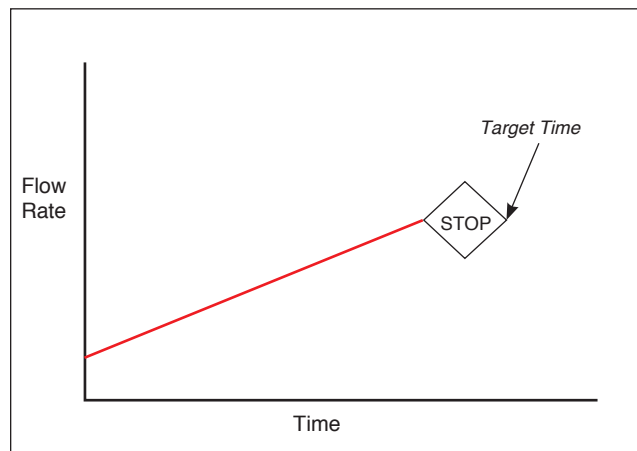

Ramp Rate Pump Operation Profile.

When creating or editing a Ramp Rate profile, you will define three primary operating parameters:

- The Flow Mode defining the direction of flow: infuse or withdraw
- The Flow Rate at the beginning and end of the pumping cycle
- The Target Time that determines the total length of time over which the ramp will be calculated

During a Ramp Rate profile, the PHD ULTRA™ varies the flow rate linearly between the starting rate and ending rate over the full time period entered. A Ramp Rate profile can be applied to an increasing or decreasing rate application.

When creating or editing a Ramp Rate profile, you can set the rate in ml, µl, nl or pl units of volume using sec or h:m:s (hours:minutes:seconds) as the units of time. The system automatically calculates a minimum and maximum flow rate based on the syringe selected or custom-defined. The min/max values are made available as button selection options on the Set Infuse and Withdraw Rate screens.

TO SET UP/EDIT A RAMP RATE PROFILE:

1. From the Step Definition screen for a Ramp Rate profile, choose the Set Mode button to toggle the Flow Mode between Infuse and Withdraw operation.

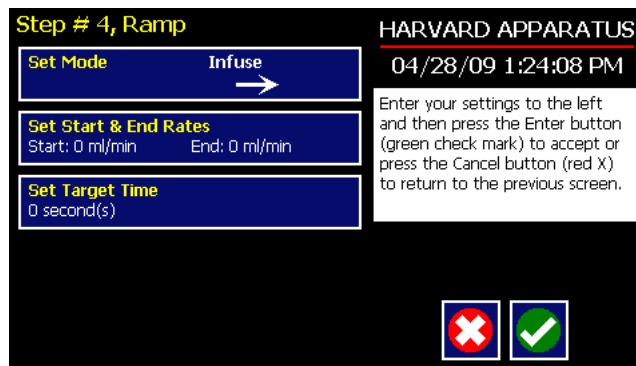

Step Definition screen for a Ramp Rate profile.

2. Choose the Set Start & End Rate button to enter the Set Start & End Rates screen.

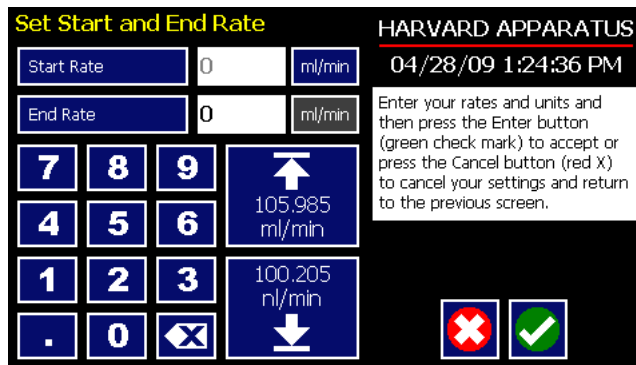

Set Start and End Rates screen.

3. Select the Start Rate button (it should be selected by default as indicated by the active data entry box to the right of the button). Enter the flow rate value desired using the keypad or select the Minimum Rate or Maximum Rate button.
4. If the Units of Rate are not correct for your application, choose the Units button.
5. On the Units Selection screen, select the unit of measure (ml, μ l, nl or pl) and the unit of time (sec, min, hr) as appropriate, then choose Accept to confirm your selections.
6. Repeat Steps 3 to 5 for the End Rate by selecting the End Rate button and continuing data entry.
7. When all parameters are correctly set on the Set Rate screen, choose Accept to confirm your settings and return to Step Definition screen.
8. Choose the Set Target Time button to enter the Set Time screen.
9. Enter the desired Time value using the keypad.
10. If the Units of Time are not correct for your application, select the Units button to toggle between sec (seconds) and h:m:s (hours:minutes:seconds). To use the h:m:s option, enter your time value in hours, minutes and seconds, separating each value with a colon.
11. When all parameters are correctly set on the Set Target Time screen, choose Accept to confirm your settings and return to the Step Definition screen.



NOTE: Ramps \leq 2 seconds from min to max rates may cause motor stalls.

STEPPED PROFILE

The Stepped Rate profile is used to create an increasing or decreasing flow rate that varies in a series of equal steps between a starting and ending flow rate.

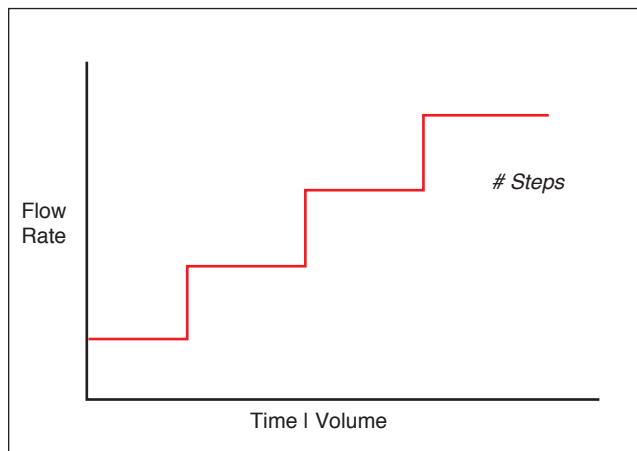

*Stepped Rate Pump
Operation Profile.*

When creating or editing a Stepped Rate profile, you will define four primary operating parameters:

- The Flow Mode defining the direction of flow: infuse or withdraw
- The Flow Rate at the beginning and end of the pumping cycle
- The Target Time that determines the total length of time over which the stepped profile will be calculated
- The Number of Steps that will be created in the profile

During a Stepped Rate profile, the PHD ULTRA™ calculates a series of equal rate increases that will vary the flow from the starting value to the ending value. You enter the Number of Steps you want to use. The Target Time defines the total length of pumping time, with the Target Time value divided equally into each stepped rate. A Stepped Rate profile can be applied to an increasing or decreasing rate application.

When creating or editing a Stepped Rate profile, you can set the rate in ml, μ l, nl or pl units of volume using sec or h:m:s (hours:minutes:seconds) as the units of time. The system automatically calculates a minimum and maximum flow rate based on the syringe selected or custom-defined. The min/max values are made available as button selection options on the Set screen.

TO SET UP/EDIT A STEPPED RATE PROFILE:

1. From the Step Definition screen for a Stepped Rate profile, choose the Set Mode button to toggle the Flow Mode between Infuse and Withdraw operation.
2. Choose the Set Start & End Rate button to enter the Set Start and End Rates screen.

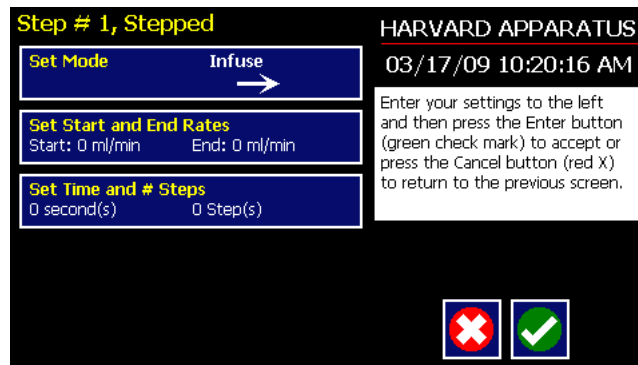
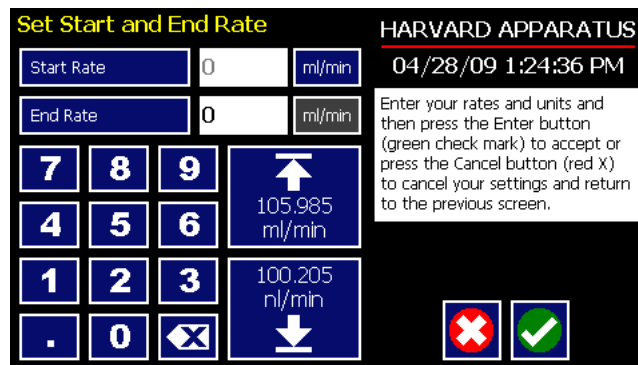
*Stepped Profile definition screen.**Set Start and End Rate screen.*

3. Select the Start Rate button (it should be selected by default as indicated by the active data entry box to the right of the button). Enter the flow rate value desired using the keypad or select the Minimum Rate or Maximum Rate button.
4. If the Units of Rate are not correct for your application, choose the Units button.
5. On the Units Selection screen, select the unit of measure (ml, μ l, nl or pl) and the unit of time (sec, min, hr) as appropriate, then choose Accept to confirm your selections.
6. Repeat Steps 3 to 5 for the End Rate by selecting the End Rate button and continuing data entry.
7. When all parameters are correctly set on the Set Rate screen, choose Accept to confirm your settings and return to Step Definition screen.
8. Choose the Set Time and # Steps button to enter the Set Time & Steps screen.
9. Select the Total Time button (it should be selected by default as indicated by the active data entry box to the right of the button). Enter the desired value using the keypad.
10. If the Units of Time are not correct for your application, select the Units button to toggle between sec (seconds) and h:m:s (hours:minutes:seconds). To use the h:m:s option, enter your time value in hours, minutes and seconds, separating each value with a colon.
11. Select the Number of Steps button and enter the desired value using the keypad.
12. When all parameters are correctly set on the Set Target Time screen, choose Accept to confirm your settings and return to the Step Definition screen.

PULSE PROFILE

The Pulse Flow profile is used to create an oscillating infusion or withdrawal profile that varies between a starting flow rate and a second rate that can be either higher or lower than the start rate. The flow rate is constant within each segment of the pulsed flow profile and the user defines the total number of repetitions (pulses) for the oscillating pattern. Each segment of the profile must be set to run for either a specific length of time or to deliver a set volume.

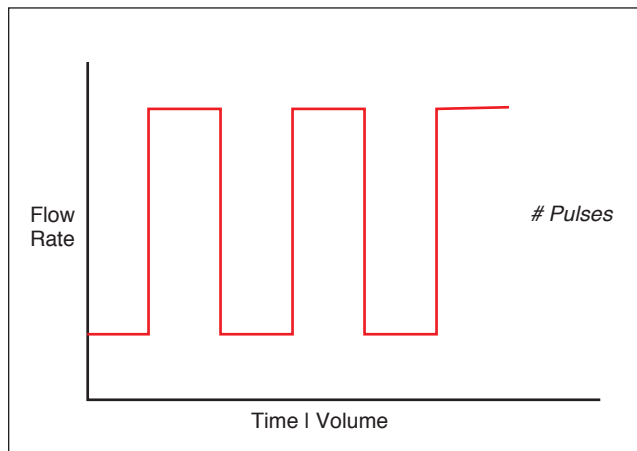

*Pulse Flow Pump
Operation Profile.*

When creating or editing a Pulse Flow profile, you will define four primary operating parameters:

- The Flow Mode defining the direction of flow: infuse or withdraw
- The Flow Rate to be used at each level of the pulsed profile within the pumping cycle
- The length of Time that each segment of the profile will run or the specific Volume to be infused/withdrawn during each segment of the profile
- The Number of Pulses (repetitions) that will be executed during the pumping cycle

During a Pulse Flow profile, the PHD ULTRA™ calculates a series of equal length pumping stages at two user-defined flow rates: a starting rate and a “pulse” rate. You enter the Number of Pulses (repetitions) that you want to use, along with how you want the system to calculate the length of each stage — by time or by volume pumped. A Pulse Rate profile can be applied to pulses that are higher in rate or lower in rate than the starting flow rate.

When creating or editing a Pulse Flow profile, you can set the rate in ml, μ l, nl or pl units of volume using sec, min or hr as the units of time. The system automatically calculates a minimum and maximum flow rate based on the syringe selected or custom-defined. The min/max values are made available as button selection options on the Set Pulse Rates screens.

Step # 4, Pulse

Set Mode Infuse →

Set Rates
Rate 1: 0 ml/min Rate 2: 0 ml/min

Set Volume
0 ml 0 ml

○ Volume

● Time

of Pulses
0 Pulse(s)

HARVARD APPARATUS
04/28/09 1:25:31 PM

Enter your settings to the left and then press the Enter button (green check mark) to accept or press the Cancel button (red X) to return to the previous screen.

✖

✔

*Step Definition screen for
a Pulse Rate Profile with
Volume mode selected.*

TO SET UP/EDIT A PULSE FLOW PROFILE:

1. From the Step Definition screen for a Pulse Rate Flow choose the Set Mode button to toggle the Flow Mode between Infuse and Withdraw operation.
2. Choose the Set Rates button to enter the Set Pulse Rates screen.
3. Select the Rate 1 button (it should be selected by default as indicated by the active data entry box to the right of the button). Enter the flow rate value desired using the keypad or select the Minimum Rate or Maximum Rate button.
4. If the Units of Rate are not correct for your application, choose the Units button.
5. On the Units Selection screen, select the unit of measure (ml, μ l, nl or pl) and the unit of time (sec, min, hr) as appropriate, then choose Accept to confirm your selections.
6. Repeat Steps 3 to 5 for the second flow rate by selecting the Rate 2 button and continuing data entry.
7. When all parameters are correctly set on the Set Pulse Rates screen, choose Accept to confirm your settings and return to Step Definition screen.
8. Select the Volume or Time button to determine how the pump cycle length will be managed. Volume calculates each cycle stage by pumping for the length of time needed to pump the specified volume. Time manages each cycle stage by pumping for the amount of time specified.
9. Depending on whether you have selected the Volume or Time button in the preceding step, choose the Set Time or the Set Volume button to enter the Set Pulse Times or the Set Pulse Volumes screens.

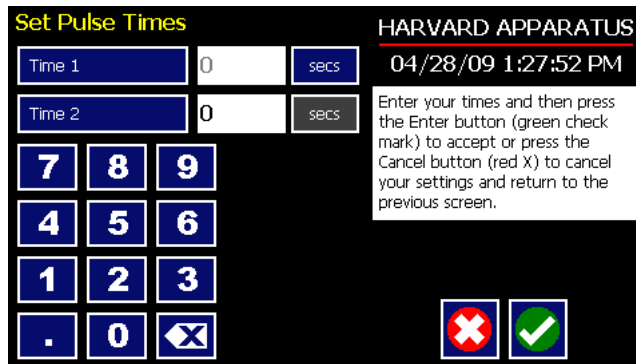

Set Pulse Times screen used to define the length of time the pump will operate at each pulse step level.

10. If you selected Set Time, continue with Step 11. If you selected Set Volume, proceed to Step 14.
11. On the Set Pulse Times screen, select the Time 1 button (it should be selected by default as indicated by the active data entry box to the right of the button). Enter the desired value using the keypad. Repeat for Time 2.
12. If the Units of Time associated with Time 1 or Time 2 are not correct for your application, select the Units button associated with either parameter to toggle between sec (seconds) and h:m:s (hours:minutes:seconds). To use the h:m:s option, enter your time value in hours, minutes and seconds, separating each value with a colon.
13. When both Time parameters are set to the correct values, choose the Accept button to return to the Step Definition screen.
14. On the Set Pulse Volumes screen, select the Volume 1 button (it should be selected by default as indicated by the active data entry box to the right of the button). Enter the desired value using the keypad. Repeat for Volume 2.
15. If the Units of Volume associated with Volume 1 or Volume 2 are not correct for your application, choose the Units button associated with either parameter to enter the Units selection screen. Select the unit of measure button (ml, μ l, nl, pl) applicable to your application, then choose the Accept button to return to the Set Pulse Volumes screen.
16. When both Volume parameters are set to the correct values, choose the Accept button to return to the Step Definition screen.
17. Select the # of Pulses button to enter the Set # Pulses screen.
18. On the Set # Pulses screen, enter the desired value using the keypad, then choose the Accept button.

BOLUS PROFILE

The Bolus Delivery profile is used to infuse a defined dose of fluid controlled by the total volume and the total time the pump operates. Bolus profiles are used for infusion only. In a bolus profile, you set both the time the pump operates and the total volume to be delivered. The pump automatically calculates the flow rate based on the syringe selected. The flow rate is constant during a Bolus Delivery profile.

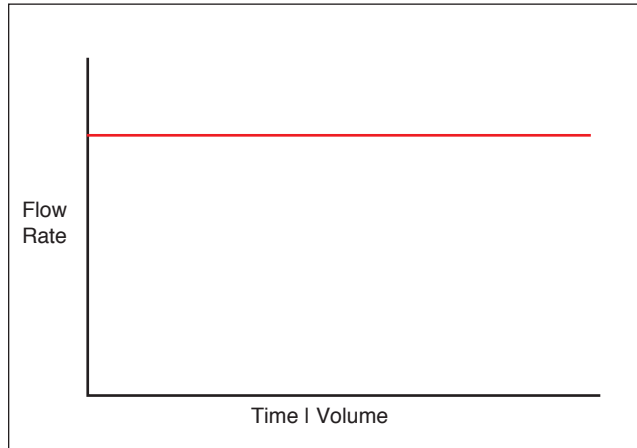

*Bolus Delivery Pump
Operation Profile.*

When creating or editing a Bolus Delivery profile, you will define the following operating parameters:

- The Target Volume to be infused.
- The Target Time value which is the total time the pump will operate.

The screenshot shows the 'Step Definition' screen for a Bolus Delivery Profile. The title is 'Step # 4, Bolus' and the device is 'HARVARD APPARATUS'. The timestamp is '04/28/09 1:28:28 PM'. The screen displays the 'Calculated Rate' as 'Rate: 100 ml/min'. There are two input fields: 'Set Target Volume' with a value of '50 ml' and 'Set Target Time' with a value of '30 second(s)'. At the bottom, there are two buttons: a red 'X' (Cancel) and a green checkmark (OK).

*Step Definition screen for a
Bolus Delivery Profile.*

TO SET UP/EDIT A BOLUS DELIVERY PROFILE:

1. From the Step Definition screen for a Bolus Delivery profile, choose the Set Target Volume button.
2. On the Set Target Volumes screen, enter the desired value using the keypad.
3. If the Units of Measure are not correct for your application, choose the Units button to enter the Units selection screen. Select the unit of measure button (ml, µl, nl, pl) applicable for your application, then choose the Accept button to return to the Set Target Volumes screen.
4. When the Volume parameters are correctly set, choose the Accept button to return to the Step Definition screen.
5. Select the Target Time button.
6. On the Set Target Times screen, enter the desired value using the keypad.
7. If the Units of Time are not correct for your application, select the Units button to toggle between sec (seconds) and h:m:s (hours:minutes:seconds). To use the h:m:s option, enter your time value in hours, minutes and seconds, separating each value with a colon.
8. When the Time parameters are correctly set, choose the Accept button to return to the Step Definition screen. The pump will automatically calculate the flow rate based on the entered Target Volume and Time.

CONCENTRATION PROFILE

The Concentration Delivery profile is used to manage infusion of a defined concentration of drug or other liquid to a set dosage level based on the subject's weight.

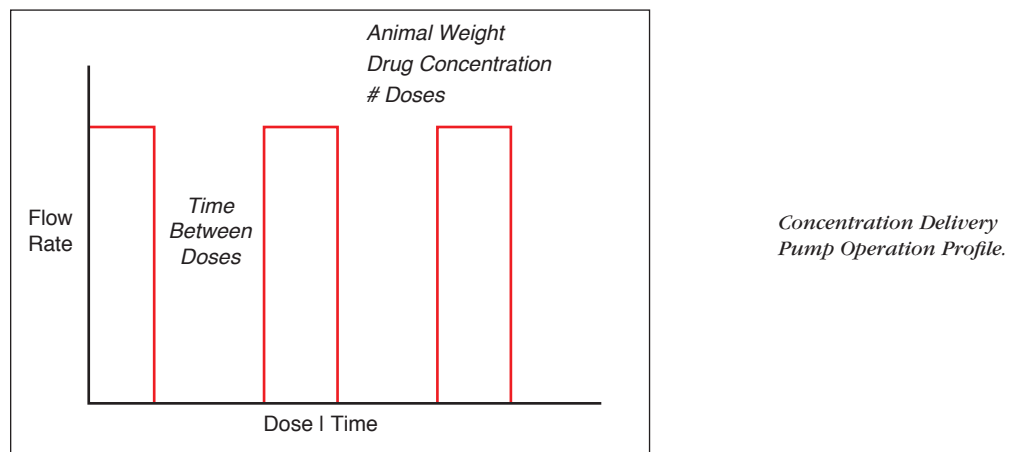

When creating or editing a Concentration Delivery profile, you will define the following operating parameters:

- The Weight of the target subject
- The Flow Rate to be used during infusion
- The concentration of the drug or other liquid being infused
- Either the target dosage or the target infusion time — the pump automatically calculates whichever value you do not enter.
- If you wish to infuse multiple doses to the target, you can specify the number of doses along with a delay between dosings.

During a Concentration profile, the PHD ULTRA™ operates at a constant infusion rate and automatically stops when the target dosage rate is reached.

When creating or editing a Concentration flow profile, you can set the rate in ml, µl, nl or pl units of volume using sec, min or hr as the units of time. The system automatically calculates a minimum and maximum flow rate based on the syringe selected or custom-defined. The min/max values are made available as button selection options on the Set Rate and Concentration screen. The ingredient concentration is entered in mg/ml.

Step Definition screen for a Concentration Delivery profile.

TO SET UP/EDIT A CONCENTRATION DELIVERY PROFILE:

1. From the Step Definition screen for a Concentration profile, choose the Animal Weight button to enter the Set Animal Weight screen.

Set Animal weight screen in Concentration profile.

2. Enter the Weight then choose the Accept button to return to the Step Definition screen.
3. Choose the Set Rate and Concentration button to enter the Set Rate and Concentration screen.

Set Rate and Concentration screen in Concentration profile.

4. Select the Infuse Rate (it should be selected by default as indicated by the active data entry box to the right of the button). Enter the desired rate using the keypad or select the Min Rate or Max Rate button.
5. If the Units of Rate are not correct for your application, choose the Units button.
6. On the Units Selection screen, select the unit of measure (ml, μ l, nl or pl) and the unit of time (sec, min, hr) as appropriate, then choose Accept to confirm your selections.
7. Select the Concentration button and enter the concentration of the active ingredient in the infusion fluid in mg/ml.
8. When all parameters are correctly set on the Set Rate and Concentration screen, choose Accept to confirm your settings and return to Step Definition screen.
9. Choose the Set Dose or Duration button to enter the Set Dose or Duration screen.
10. On the Set Dose or Duration screen, select either the Dose button (if you wish to enter the target dosage value in which case the PHD ULTRA™ will calculate the required pumping duration) or Duration (if you wish to infuse for a specific time period in which case the PHD ULTRA™ will calculate the delivered dose).
11. As appropriate enter either the Dose in mg/ml or the Duration using the keypad.
12. If the Units of Time associated with Duration are not correct for your application, select the Units button to toggle between sec (seconds) and h:m:s (hours:minutes:seconds). To use the h:m:s option, enter your time value in hours, minutes and seconds, separating each value with a colon.
13. When all parameters on the Set Dose or Duration screen are correct, choose the Accept button to return to the Step Definition screen.
14. Choose the Set # Doses & Time Between Doses button to enter the Set # Doses & Time Lag screen.

Set # Doses and Time Lag screen in Concentration profile.

15. Select the Doses button (it should be selected by default as indicated by the active data entry box to the right of the button). Enter the desired number of doses using the keypad.
16. If the # Doses is greater than one, select the Time Lag button and enter the desired length of time between individual doses.
17. If the Units of Time associated with Time Lag are not correct for your application, select the Units button to toggle between sec (seconds) and h:m:s (hours:minutes:seconds). To use the h:m:s option, enter your time value in hours, minutes and seconds, separating each value with a colon.
18. When all parameters on the Set # Doses & Time Lag screen are correct, choose the Accept button to return to the Step Definition screen.

GRADIENT PROFILE (Available in firmware v1.2.2 and later)

The Gradient profile is used to combine multiple flow streams from different pumps into a common output stream. The flow profiles can be flat or ramped smooth flowing or can execute in a stepped format.

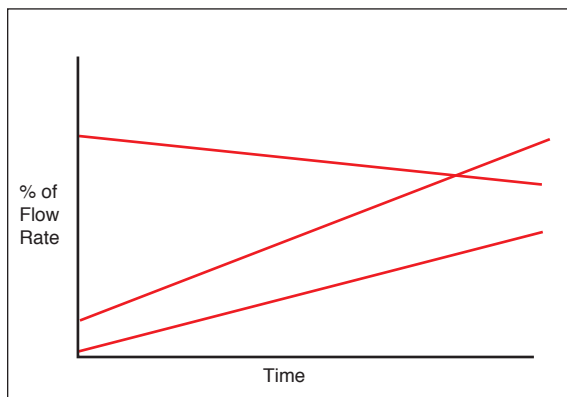

*Gradient Delivery Pump
Operation Profile.*

When creating or editing a Gradient profile you will define 4 primary operating parameters:

- The combined Flow Rate
- The Target Starting and Ending Percentages for each pump in the system.
- The Target Time that determines the total length of time over which the Gradient profile will be calculated
- The Number of Steps that will be created in the profile



NOTE: See Appendix E: External Connections for instructions on setting up a Gradient System and controlling satellite pumps.



NOTE: Master ADDRESS must be set at 00. Satellite ADDRESSES range from 01 to 99 and must be set thru USB. While the actual satellite's address is not zero, ensure that the Remote Address field under the settings screen is set to 0 when running a gradient step.



CAUTION: All pumps must use the same syringe size and type. If there is a syringe change at Master then same change must occur at all Satellites.



CAUTION: For firmware versions prior to 1.3.0, force changed at Master will not change Force Setting at Satellite. Must set thru USB if different Force is desired at the Satellite(s).



NOTE: Make all cable connections, then power-up the satellite pump before powering-up the master pump.

TO SET UP/EDIT A GRADIENT PROFILE:

1. From the Step Definition screen for Gradient, choose Set Combined Flow Rate to enter the Set Rate screen.

*Gradient Step Definition
Screen.*

2. Enter the desired combined flow rate value for all pumps using the keypad or select the Minimum Rate or Maximum Rate button.

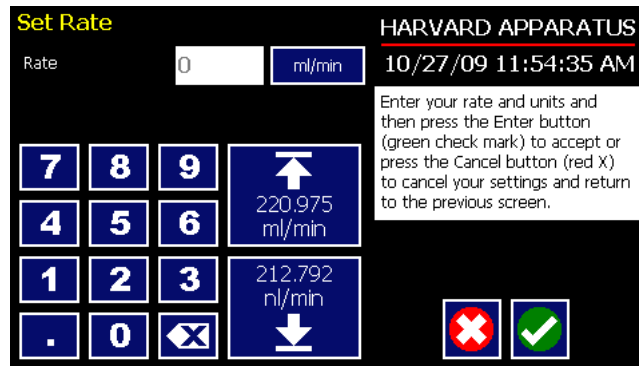

Combined Flow Rate Entry screen.

3. If the Units of Rate are not correct for your application, choose the Units button.
4. On the Units Selection screen, select the unit of measure (ml, μ l, nl, or pl) and the unit of time (sec, min, hr) as appropriate, then choose Accept to confirm your selections.
5. When all parameters are correctly set on the Set Rate screen, choose Accept to confirm your settings and return to the Step Definition screen.
6. Choose the Set Percentages button for pump 00.
7. Set the Start and End Percentages for pump 00 then choose Accept.
8. Choose the Address button, and then set the address of the second pump. Choose Accept to return to the Step Definition screen.

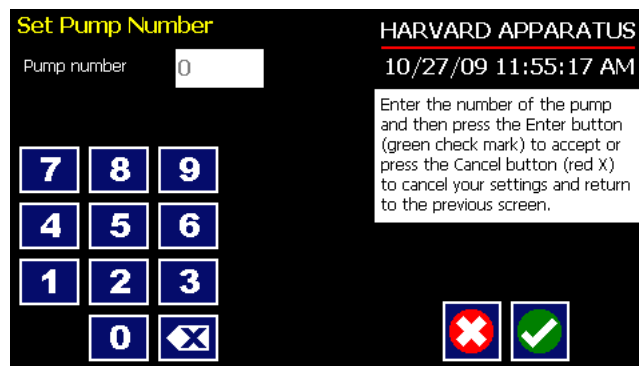

Gradient Pump Address Entry Screen.

9. Choose the Set Percentages button for the second pump and enter your desired percentage then press the accept button.
10. Choose the second Address button, and then set the address of the third pump. Choose Accept to return to the Step Definition screen.
11. The pump will calculate the remaining percentages for the third pump.



NOTE: If performing binary gradients, you do not have to set the address for the third pump. Verify that the calculated values for this non-existent pump are equal to zero %.



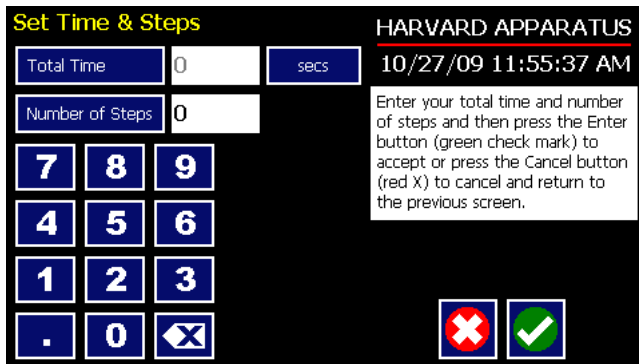

NOTE: To unassign a pump from a gradient step, set pump address to zero in the Set Pump Number screen.

12. Choose the Set Time & Steps button. Enter the total amount of time and the number of steps desired and then choose Accept.



Gradient Time and Type Entry Screen.



NOTE: For a Constant rate  or Ramp  profile choose 0 steps. For a Stepped profile  select the number of steps desired.



NOTE: When running a gradient step, ensure that no unused pumps are included in the pump chain.

AUTOFILL CYCLING PROFILE

The Autofill Cycling Profile is an automated Infuse/Withdraw or Withdraw/Infuse step that operates at constant, but separately defined, flow rates for the withdraw and infuse operations. The Autofill profile is designed to work in conjunction with an autofill valve that controls the switching of flows from a reservoir for refilling the syringe, to the target infusion subject.



NOTE: Pin 8 of the 15-pin I/O Connector adapter on the rear of the PHD ULTRA™ will actuate to control a Harvard Apparatus Valve Box used in conjunction with an Autofill Pump Operation Profile.

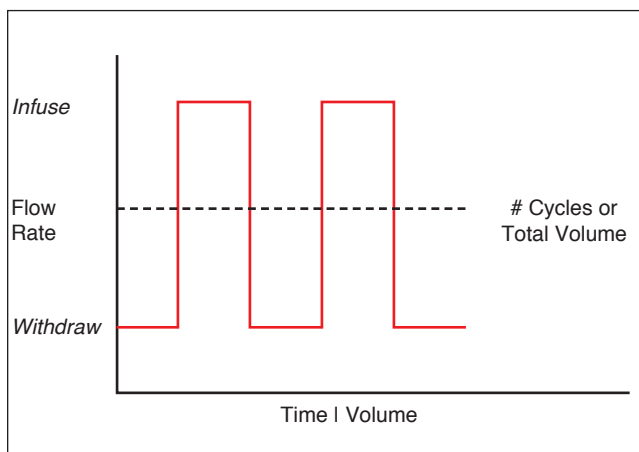

Autofill Cycling Pump Operation Profile.

When creating or editing an Autofill Cycling profile, you will define the following operating parameters:

- The Flow Mode defining the cycle: Infuse/Withdraw (INF/WD) or Withdraw/Infuse (WD/INF)
- The Flow Rates to be used during infuse/withdraw operations
- The infusion volume to be delivered during each pump cycle
- The total volume to be delivered during all cycles or the total number of Infuse/Withdraw or Withdraw/Infuse cycles that you want the pump to execute. For example, if you want to pump 100 ml using a 10 ml syringe, the pump will execute 10 Infuse/Withdraw or Withdraw/Infuse cycles, depending upon the chosen flow mode.

During an Autofill profile, the PHD ULTRA™ operates at a constant pump rate during the infusion and withdrawal stages, although the rate can be different for each direction (i.e. infuse vs. withdraw).

When creating or editing an Autofill Cycling profile, you can set the rate in ml, μ l, nl or pl units of volume using sec, min or hr as the units of time. The system automatically calculates a minimum and maximum flow rate based on the syringe selected or custom-defined. The min/max values are made available as button selection options on the Set Rate and Concentration screen.

Step # 1, Autofill		HARVARD APPARATUS	
Set Mode	INF/WD	04/28/09 1:38:44 PM	
Set Rates	INF: 0 ml/min WD: 0 ml/min	Enter your settings to the left and then press the Enter button (green check mark) to accept or press the Cancel button (red X) to return to the previous screen.	
Set Volume per Cycle	50 ml per Cycle		
Set Total Volume or # Cycles	0 ml		
		<input type="button" value="X"/> <input type="button" value="✓"/>	

Step Definition screen for an Autofill cycling profile.

TO SET UP/EDIT AN AUTOFILL CYCLING PROFILE:

1. From the Step Definition screen for an Autofill Cycling, choose the Set mode button to toggle between the Withdraw/Infuse (WD/INF) and Infuse/Withdraw (INF/WD) modes. Withdraw/Infuse begins by withdrawing into the syringe, following by infusing into the target.
2. Choose the Set Rates button to enter the Set Infuse/Withdraw Rate screen.
3. Select the Infuse Rate (it should be selected by default as indicated by the active data entry box to the right of the button). Enter the desired rate using the keypad or select the Minimum Rate or Maximum Rate button.
4. If the Units of Rate are not correct for your application, choose the Units button.
5. On the Units Selection screen, select the unit of measure (ml, μ l, nl or pl) and the unit of time (sec, min, hr) as appropriate, then choose Accept to confirm your selections.
6. Select the Withdraw Rate and enter the desired rate using the keypad or select the Minimum Rate or Maximum Rate button.
7. When all parameters are correctly set on the Set Infuse/Withdraw Rate screen, choose Accept to confirm your settings and return to Step Definition screen.
8. Choose the Set Volume per Cycle button to enter the Set Volume per Cycle screen.
9. Enter the Volume using the keypad.
10. If the Units of Measure associated with Volume are not correct for your application, choose the Units button to enter the Units selection screen. Select the unit of measure button (ml, μ l, nl, pl) appropriate for your application, then choose the Accept button to return to the Set Target Volumes screen.
11. When all parameters on the Set Volume per Cycle screen are correct, choose the Accept button to return to the Step Definition screen.
12. Choose the Set Total Volume or # Cycles button to enter the Set Total Volume or # Cycles screen.
13. Select either Total Volume or # Cycles to define how the pump will control pumping activity. Total Volume will cycle the pump the correct number of times to deliver the total volume according to the Volume per Cycle setting. For example, if you set a 10 ml Volume per Cycle and set 100 ml in Total Volume, the pump will cycle 10 times.
14. If you select Total Volume, enter the volume desired using the keypad. If you select # Cycles, enter the total number of Infuse/Withdraw or Withdraw/Infuse cycles that you wish to perform.
15. If the Units of Measure associated with Volume are not correct for your application, choose the Units button to enter the Units selection screen. Select the unit of measure button (ml, μ l, nl, pl) appropriate for your application, then choose the Accept button to return to the Set Target Volumes screen.
16. When all parameters on the Set Total Volume or # Cycles screen are correct, choose the Accept button to return to the Step Definition screen.



NOTE: Using maximum rate may not be appropriate during the Withdraw stage of an Autofill profile, since air can be drawn into the syringe, or a high vacuum pressure can be produced depending on the syringe and/or tubing being used, or the fluid viscosity.

Incorporating Advanced Options (Commands and I/O) Into A Method

PHD ULTRA™ Methods can incorporate a variety of commands that expand the versatility of the system by permitting convenient looping, chaining of events, sending signals to external devices, or accepting inbound signals from external devices. These Advanced Options controls are described in this section of the Guide.

To access the Advanced Options, choose Advanced Options from the Select Profile screen.

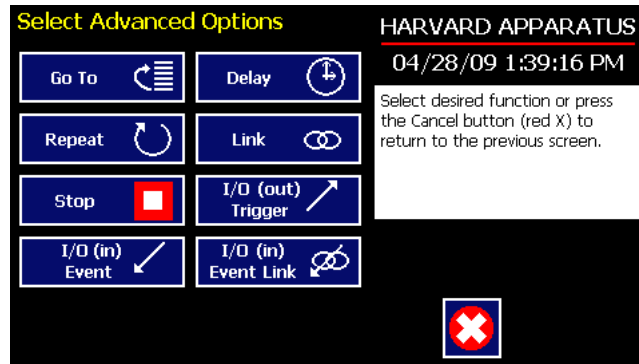

Method Step Profile Selection Advanced Options screen showing available command options.

GO TO STEP

The Go To Command is used to instruct the PHD ULTRA™ to jump to a particular Step in a Method. This can be used to help you loop back or jump forward in a Method protocol and can be used in conjunction with I/O Events to make the pump respond to a trigger from an external device.

When defining a Go To jump in a Method, the Command targets the Step sequence position and not the function that currently occupies that position. For example, if you create a Go To jump to Step 4 in a Method (currently a Bolus Pump Operation Profile) and subsequently move a Constant Rate profile into the Step 4 position, the Go To jump will then connect to the Constant Rate operation and not to the Bolus operation.

TO INSERT A GO TO JUMP:

1. From the Method Main screen, choose Step Definition to enter the Method Steps Summary screen.
2. Highlight (select once) the Method Step that you want the Go To jump to follow.
3. Choose the Add Step button to access the Method Steps Menu screen.
4. Choose Advanced Options to enter the Set Advanced Options screen.
5. Choose Go To to insert the Go To Step and view an updated list of all current Steps in the Method.

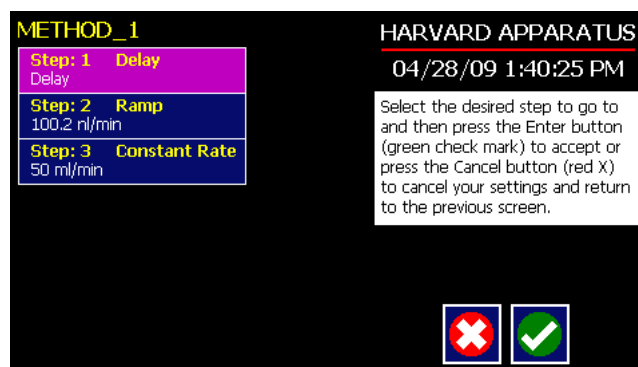

Advanced Options Go To Step screen. Choosing the Go To Command brings you to a listing of the available steps in the Method.

6. Double tap the Step that you want to jump to with the Go To Command. The system automatically returns to the Method Steps Summary screen which now shows the Go To Step inserted in the Method.

DELAY

The Delay Command is used to insert a time delay in a procedure. You can program a time delay between 0.2 seconds up to 99:99:99 (99 hours, 99 minutes, 99 seconds).

TO INSERT A TIME DELAY IN A METHOD:

1. From the Method Main screen, choose Step Definition to enter the Method Steps Summary screen.
2. Highlight (select once) the Method Step that you want the time delay to follow.
3. Choose the Add Step button to access the Method Steps Menu screen.
4. Choose Advanced Options to enter the Set Advanced Options screen.
5. Choose Delay to enter the Set Delay screen.

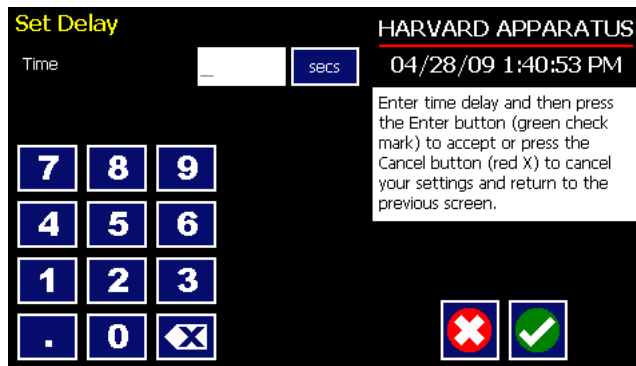

Advanced Options Set Delay screen.

6. Enter the desired Time using the keypad.
7. If the Units of Time associated with Time are not correct for your application, select the Units button to toggle between sec (seconds) [0.2 seconds minimum allowable value] and h:m:s (hours:minutes:seconds). To use the h:m:s option, enter your time value in hours, minutes and seconds, separating each value with a colon. You can enter a value up to 99:99:99.
8. When your Time entry is correct, choose the Accept button to insert the Delay Step in the Method and return to the Method Steps Summary screen.

REPEAT STEP

The Repeat Command is used to repeat Steps in a procedure a defined number of times. To use this Command, you will tell the application what Steps you want to Repeat and how many times you want them repeated. The Repeat Step command creates a “jump” back to a specific Step in a Method that executes the defined Step plus all following Steps up to the Repeat command (i.e. it creates a Method loop).

When defining a Repeat jump in a Method, the Command targets the Step sequence position and not the function that currently occupies that position. For example, if you create a Repeat jump to Step 4 in a Method (currently a Bolus Pump Operation Profile) and subsequently move a Constant Rate profile into the Step 4 position, the Repeat jump will then connect to the Constant Rate operation and not to the Bolus operation.



NOTE: Do not use nested loops (repeat within a repeat)

TO INSERT A STEP REPEAT SEQUENCE IN A METHOD:

1. From the Method Main screen, choose Step Definition to enter the Method Steps Summary screen.
2. Highlight (select once) the Method Step that you want the repeat step to follow.
3. Choose the Add Step button to access the Method Steps Menu screen.
4. Choose Advanced Options to enter the Set Advanced Options screen.
5. Choose Repeat to insert the Repeat Step function into the Method.
6. Select the Step(s) you would like to repeat from by selecting the Step button twice or selecting once and then choosing Accept.

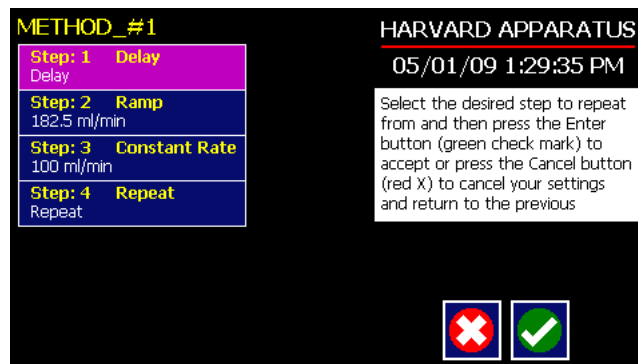

Advanced Options Repeat Step screen. Choosing Repeat brings you to a listing of the available steps in the Method.

7. Enter the number of repeats using the keypad then choose the Accept button to save your changes and return to the Method Steps Summary screen.

This command creates a loopback to the designated Step in a Method, executing the selected Step, plus all subsequent Steps up to the point of insertion of the Repeat command. For example, in the above figure, if the Repeat command is set to repeat Step 2 one time, the system will loop back to Step 2 and execute both Steps 2 and 3 one additional time.

LINK METHOD

The Link Command is used to insert a link to another stored Method into the operating sequence of a Method. You can Link a Method any place in the Method sequence.

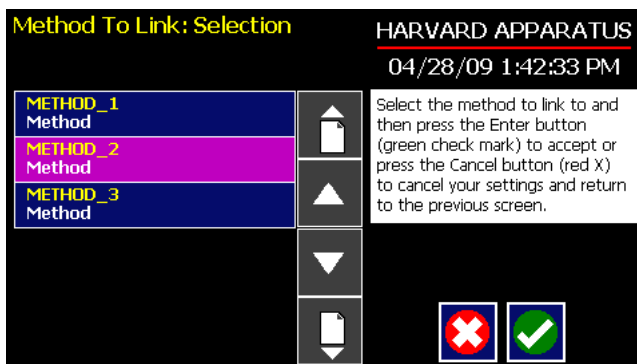

Advanced Options Link Command selection screen.

TO LINK TO A STORED METHOD:

1. From the Method Main screen, choose Step Definition to enter the Method Steps Summary screen.
2. Highlight (select once) the Method Step that you want the Link Command to follow.
3. Choose the Add Step button to access the Method Steps Menu screen.
4. Choose Advanced Options to enter the Set Advanced Options screen.
5. Choose Link to enter the Link Selection screen and display a list of the saved Methods available.
6. Double tap the Method that you want to link to in the current Method. If the desired Method is not listed on the screen, use the Scroll Up/Scroll Down or Page Up/Page Down buttons to scroll through the Method List. Upon selection you are returned to the Method Steps Summary screen.

STOP

The Stop Command is used to instruct the pump to stop operation. This Command can be used in conjunction with I/O Events to control pump operation based on external events.

TO INSERT A STOP COMMAND IN A METHOD:

1. From the Method Main screen, choose Step Definition to enter the Method Steps Summary screen.
2. Highlight (select once) the Method Step that you want the Stop Command to follow.
3. Choose the Add Step button to access the Method Steps Menu screen.
4. Choose Advanced Options to enter the Set Advanced Options screen.
5. Choose Stop to insert the Stop Command into the Method.

I/O EVENT TRIGGERS

The PHD ULTRA™ pump permits easy connection to external I/O devices via a variety of interfaces, including a built-in 15-pin D-sub connector. The PHD ULTRA™ software contains simple commands for incorporating I/O controls into your pump Methods. Integrated commands for control of an external valve, multi-pump synchronization, and general trigger signals are integrated in the software. The following procedure describes the use of the Advanced Options I/O commands. Following the procedure is a description of the selection menu options for each of the I/O command types. Details for the electrical connection controls and pin-out description for the 15-pin User I/O Connector are provided in Appendix E of this manual.

The PHD ULTRA™ manages trigger events through specific pins on the I/O Connector port on the back of the pump. The following details define pin logic:

- Triggers are communicated via Pin 4 or Pin 5.
- Pump synchronization commands are communicated via Pin 6.
- Event signals are communicated via Pin 2.

I/O TRIGGER (OUT)

The I/O Trigger (out) command is used to send a signal to an external device when the Step in the Method is reached.

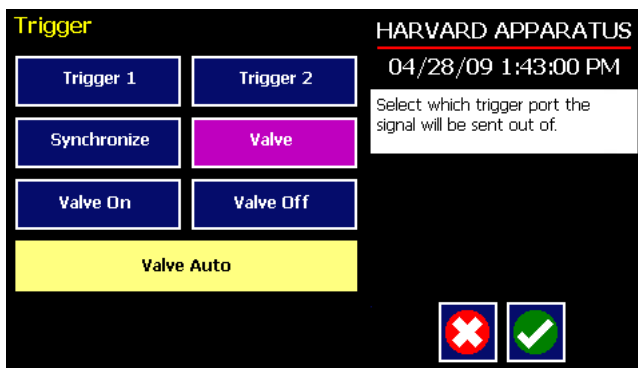

*Advanced Options
I/O Trigger (out) Selection
Screen.*

The following options are available when setting an I/O Trigger (out) command:

- **Trigger 1:** Specifies output via the Trigger 1 (Pin 4) port. When selected, you must also specify whether the signal to be sent is High Signal or Low Signal.
 - **High Signal:** Sets the output signal to logic high.
 - **Low Signal:** Sets the output signal to logic low.
- **Trigger 2:** Specifies output via the Trigger 2 (Pin 5) port. When selected, you must also specify whether the signal to be sent is High Signal or Low Signal.
 - **High Signal:** Sets the output signal to logic high.
 - **Low Signal:** Sets the output signal to logic low.
- **Synchronize:** Select this to send a signal via Pin 6 to a connected pump to trigger activity. When selected, you must define whether the desired action is to start an Infuse activity or a Withdraw (Refill) activity.
 - **Start Infuse:** Defines the rising edge signal to trigger an infusion action.
 - **Start Withdraw:** Defines the falling edge signal to trigger a withdraw (refill) action.
- **Valve:** Select automatic or manual valve control (automatic is controlled by pumping). [pin 8]
 - **Valve On:** Activates the valve.
 - **Valve Off:** De-Activates the valve.
 - **Valve Auto:** Returns the pump to Automatic valve control.

TO INSERT AN I/O TRIGGER (OUT) COMMAND:

1. From the Method Main screen, choose Step Definition to enter the Method Steps Summary screen.
2. Highlight (select once) the Method Step that you want the I/O Trigger (Out) to follow.
3. Choose the Add Step button to access the Method Steps Menu screen.
4. Choose Advanced Options to enter the Select Advanced Options screen.
5. Choose the I/O Trigger (out) button to enter the Trigger Step Definition Screen.
6. Set your Trigger settings by choosing the appropriate option from the following sub-procedures:
 - a. To send a Trigger signal to an external device via Pin 4, select the Trigger 1 button. To send a Trigger signal via Pin 5, select the Trigger 2 button. Then select whether the signal will be High or Low by selecting the appropriate button.
 - b. To send a trigger signal to an external valve, select Valve. Then select whether the trigger will actuate (On button) or close (Off button) by selecting the appropriate button. This overrides the 'Valve Auto' setting, which means that the valve is controlled by a direction change. The valve will default back to 'auto' after leaving the Method Run screen.
 - c. To send a synchronization signal to a connected pump, select Synchronize. Then select whether you want to start an infusion action (Start Infuse button) or a withdraw action (Start Withdraw button) by selecting the appropriate button.
7. Choose the Accept button to save your changes and return to the Method Steps Summary screen.



NOTE: When using triggers, the first step in your method should define the trigger starting level (High or Low). You may then use the trigger command to change the level as desired for your Method.

I/O EVENT (IN)

The I/O Event (in) command is used to have the pump pause and wait for a signal from an external device or for a manual user input at the touchscreen. These external signals are communicated via Pin 2 on the 15-pin I/O Connector port.

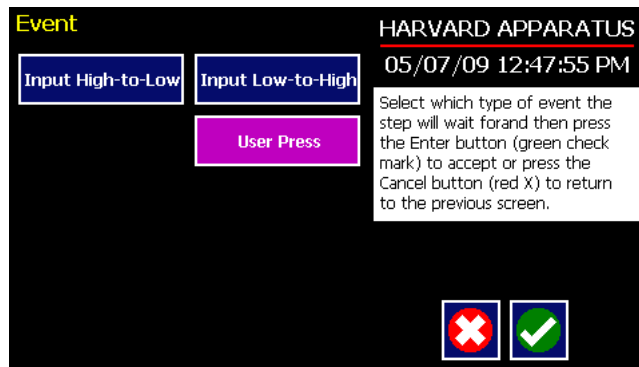

*Advanced Options menu
I/O Event (in) Selection
Screen.*

The following options are available when setting an I/O Event (in) command.

- **Input High-to-Low:** Sets the pump to wait for a logic low input signal falling edge.
- **Input Low-to-High:** Sets the pump to wait for a logic high input signal rising edge.
- **User Press:** Sets the pump to wait for manual input from the user at the touchscreen (screen touch).

TO INSERT AN I/O EVENT (IN) COMMAND:

1. From the Method Main screen, choose Step Definition to enter the Method Steps Summary screen.
2. Highlight (select once) the Method Step that you want the I/O Event (in) to follow.
3. Choose the Add Step button to access the Method Steps Menu screen.
4. Choose Advanced Options to enter the Select Advanced Options screen.
5. Choose the I/O Event (in) button to enter the Event Step Definition Screen.
6. Select either Input High, Input Low or User Press, as appropriate.
7. Choose the Accept button to save your changes and return to the Method Steps Summary screen.

I/O EVENT LINK (IN)

The I/O Event Link (in) command is used to have the pump jump to a linked method if the signal is received. The external signals are communicated via Pin 2 on the 15-pin I/O Connector.

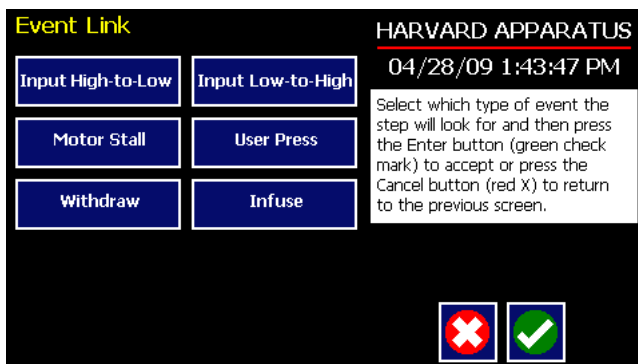

Advanced Options I/O Event Link (in) Selection Screen.

The following options are available when setting an I/O Event Link (in) command. This command requires that you have a method set with the specific actions (steps) you want to perform if the event occurs so that you can choose the Method name being linked by this command.

- **Input High-to-Low:** Will link to the desired method upon a logic low input signal falling edge.
- **Input Low-to-High:** Will link to the desired method upon a logic high input signal rising edge.
- **User Press:** Will link to the desired method upon a manual input.
- **Motor Stall:** Will link to the desired method upon a Motor Stall event.
- **Withdraw:** Will link to the desired method upon a Withdraw activity.
- **Infuse:** Will link to the desired method upon an Infuse activity.

TO INSERT AN I/O EVENT LINK (IN) COMMAND:

1. From the Method Main screen, choose Step Definition to enter the Method Summary screen.
2. Highlight (select once) the Method Step that you want the I/O Event Link (in) command to follow.
3. Choose the Add Step button to access the Method Steps Menu screen.
4. Choose Advanced Options to enter the Select Advanced Options screen.
5. Choose the I/O Event Link (in) button to enter the Event Link Step Definition Screen.
6. Select the desired Event type that you want to have the event associated with from the options available (Input Low, Input High, User Press, Motor Stall, Withdraw, Infuse).
7. After selecting the desired option in the Event Link screen, choose Accept to access the Method Steps Summary selection screen. Choose the Method name to jump to. To use this command, you must have defined a linkable Method.
8. Choose the Accept button to save your changes and return to the Method Steps Summary screen.



NOTE: Since the 'Event Link' will cause a jump (link) to a different method, be cautious not to use embedded links in your method programming.

MANAGING EZ PRO™ METHODS

All Preloaded and User-Defined Methods are stored in the Method List for ongoing use. Over time, you may want to manage previously created Methods to keep your Method List easy to navigate. In addition, the PHD ULTRA™ allows you to export Method information to an externally connected pump or to a computer that will be used to control operation. This section of the Guide describes the file management facilities available on the PHD ULTRA™.



NOTE: The method management procedures outlined in this section are not available for Quick Start or Analog Mode Methods.

Saving A Copy Of A Method

Follow these instructions to save a copy of a Method under a new name:

1. From the Quick Start or Method Main screen, choose the Method Select button to enter the Method Selection screen.
2. From the list of available Methods, select (press once) the Method you want to save a copy of, then choose the File Options button to enter the File Options screen.
3. Choose Save As/Copy to access the Method Name Entry screen. The current Method Name will be displayed in the text entry box.
4. On the Method Name screen, type the new name for your Method (up to 15 characters) using the onscreen keyboard. Choose the Symbols/Numbers button (.?123) to display the list of available numbers and symbols that can be included in the Method Name. To switch the keyboard back to letters mode, choose the Letters button (ABC).
5. When finished entering the new Method Name, choose Accept to save your changes and return to the File Options screen.
6. Choose Back to return to the Method Selection screen.

Renaming A Method

Follow these instructions to rename a previously saved Method:

1. From the Quick Start or Method Main screen, choose the Method Select button to enter the Method Selection screen.
2. From the list of available Methods, select (press once) the Method you want to rename, then choose the File Options button to enter the File Options screen.
3. Choose Rename Method to access the Method Name Entry screen. The current Method Name will be displayed in the text entry box.
4. On the Method Name screen, type the new name for your Method using the onscreen keyboard. Choose the Symbols/Numbers button (.?123) to display the list of available numbers and symbols that can be included in the Method Name. To switch the keyboard back to letters mode, choose the Letters button (ABC).
5. When finished entering the new Method Name, choose Accept to save your changes and return to the File Options screen.
6. Choose Back to return to the Method Selection screen.

Appending A Method

Follow these instructions to Append a previously created Method into a new Method:

1. From the Quick Start or Method Main screen, choose the Method Select button to enter the Method Selection screen.
2. From the list of available Methods, select (press once) the Method you want as the base Method.
3. Choose the File Options button to enter the File Options screen.
4. Choose Append to access the Method to Append screen.
5. Choose (press twice) the Method you would like to Append (attach) to your base Method. The pump will return you to the File Options screen and display a confirmation that the Method was copied.
6. Choose Back to return to the Method Selection screen.

Deleting A Method

Follow these instructions to delete a previously saved Method:

1. From the Quick Start or Method Main screen, choose the Method Select button to enter the Method Selection screen.
2. From the list of available Methods, select (press once) the Method you want to delete, then choose the File Options button to enter the File Options screen.
3. Choose Delete Method. The application will display a warning message in the Message Area asking you to confirm your deletion request.
4. Choose Delete Method again to confirm the deletion and return to the Method Selection screen.

PHD ULTRA™ Method Export and Import

The PHD ULTRA™ pump permits the daisy chaining of multiple pumps, as well as integration with/control by an external computer through HyperTerminal. To facilitate operation in these modes, the PHD ULTRA™ application software includes a variety of commands designed to simplify the export/import of Methods between the pump and external devices. This section outlines the use of these commands.

NOTE:



- If both pumps have software versions 2.0.0 or higher, methods can be transferred via RS-485
- If both pumps have software versions 1.3.7 or lower, methods can be transferred via RS-485
- If one pump has software version 1.3.7 or lower and the other pump has 2.0.0 or higher, methods must first be uploaded to the PC and then downloaded to the desired pump using the Method Manager program



NOTE: Do not attempt to Export/Import Methods while the pump is running. Do not change screens while Importing/Exporting a method.



NOTE: For additional details on the physical interfaces used to connect the PHD ULTRA™ to external devices, refer to the External I/O Connections section in the Appendices.



NOTE: Before downloading or transferring a method to the pump, verify the number of steps available on the pump information screen.

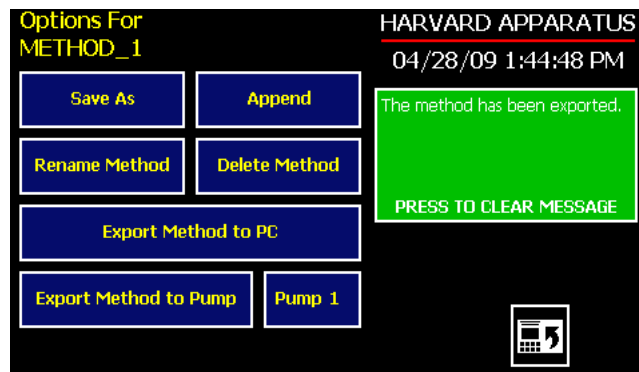

Export Method confirmation screen showing successful export.

TRANSFER A METHOD BETWEEN PUMPS

Follow these instructions to transfer a Method between two PHD ULTRA™ pumps.

1. Connect two pumps together via a RS-485 (firewire type) cable and set the address on the first pump to '00' using the Set Pump Address command in the Settings menu.
2. Set the address on the second pump to something other than '00' using the Set Pump Address command in the Settings menu.
3. On the first pump, from the Method Main screen, choose Method Select then choose the Method you would like to export.
4. Choose the File Options button then choose the Pump button and enter the address of the pump you would like to receive the Method.
5. Choose Export Method to Pump.
6. The pump will display a confirmation message in the Message Area on the screen when the export is complete. Note that long Methods may take a few seconds to export.
7. Before disconnecting the pumps, verify that the Method was successfully exported by choosing Method Select from the Method Main screen on the destination pump, then browse the available Methods to verify that the exported Method is shown in the menu.

EXPORTING A METHOD TO AN EXTERNAL COMPUTER

Follow these instructions to export a Method to an external computer.

1. Connect the pump to the external computer via an RS-232 or USB cable.
2. On the computer, open the HyperTerminal application and verify that the computer can communicate with the pump.
3. On the PHD ULTRA™, from the Method Main screen, choose Method Select then choose the Method you would like to export.
4. Choose the File Options button.
5. In HyperTerminal, choose Transfer→Capture Text...
6. Enter the File Name that you want to save the Method under, then choose Start.
7. Choose Export Method to PC.
8. The pump will display a confirmation message in the Message Area on the screen when the export is complete. Note that long Methods may take a few seconds to export.
9. At the destination computer, in HyperTerminal, when the Method is done transferring, the message “mend” will appear onscreen.
10. In HyperTerminal, choose Transfer→Capture Text...→Stop. Your Method is now saved on the external computer.

IMPORTING A METHOD FROM AN EXTERNAL COMPUTER

Follow these instructions to import a Method from an external computer.

1. Connect the pump to the external computer via an RS-232 or USB cable and set the Address value to '00' using the Set Pump Address command in the Settings menu.
2. On the computer, open the HyperTerminal application and verify that the computer can communicate with the pump.
3. In HyperTerminal, click on the Properties icons and choose the Settings tab on the pop-up box that is displayed.
4. Click on the ASCII Setup button.
5. In the Line Delay field, enter 500. This will set a 500 millisecond delay after each line is transferred during the import process.
6. Click OK twice to return to the HyperTerminal Main Menu screen.
7. In HyperTerminal, choose Transfer→Send Text File...
8. Select the Method that you want to import to the PHD ULTRA™ pump and click Open.
9. Before disconnecting, verify that the Method was transferred by choosing Method Select from the Method Main screen at the destination PHD ULTRA™ pump, then browse the Method menu to confirm that the new Method is now saved at the pump.



NOTE: The Harvard Apparatus Method Manager program, provided on the ULTRA CD, can be used to simplify the import / export process for programmable pumps. Please refer to the Method Manger manual for instructions.



EXTERNAL PUMP CONTROL

This section of the PHD ULTRA™ manual describes the control of the pump using an external computer device.



NOTE: The Harvard Apparatus Pump Terminal program, provided on the PHD ULTRA CD, can be used for easy external control of the PHD ULTRA through RS-232 or USB connection.

Setting Up HyperTerminal

HyperTerminal is a Windows application designed to support the external control of devices such as the PHD ULTRA™ pump through an RS-232 or USB connection. The following instructions describe the configuration of the HyperTerminal application.

1. Select “Start - All Programs - Accessories - Communications - HyperTerminal”.



2. Enter a name for a New Connection (i.e PHD_Ultra_Comm), then click OK.



3. Select the Virtual Comm Port from the “Connect using” drop-down list. Click OK. (If the Virtual Comm Port is not known, use Device Manager to find it. Instructions on setting up the Virtual CommPort Driver are supplied in Appendix E.)

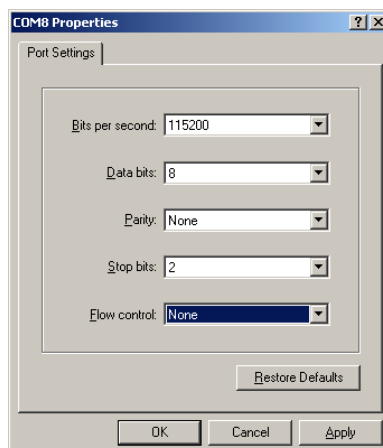

4. Set up the Port Settings as shown above and click OK.

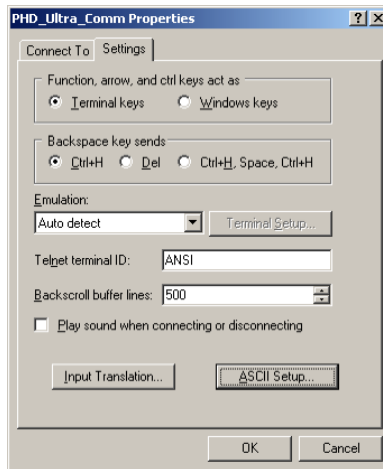

5. Verify the Settings are as shown above.

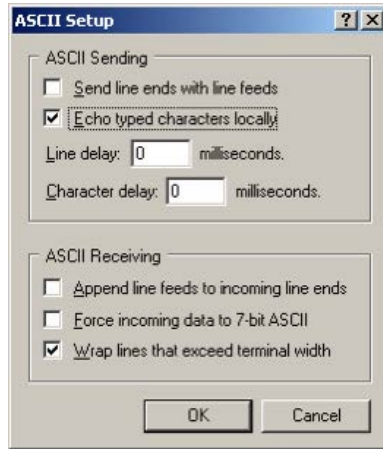

6. Choose ASCII Setup and select “Echo typed characters locally” then click OK to complete the setup.

PUMP CHAIN COMMANDS

The Pump Chain commands allow all pump control information to be managed from an external computer source. These commands can also be used to control a series of pumps (up to 100) from a single computer interface.

PHD ULTRA™ commands are communicated to the pump via the RS-232 or USB port interfaces through a terminal program such as HyperTerminal. In using the Pump Chain commands, you will need to assign each pump in the pump chain a unique address, using the Set Pump Address command in the Settings menu. The address range is from 00 to 99. This address value is used to identify which pump is to receive a command and which pump is responding. The first pump in the chain, the one connected to the computer, must use address 0 (zero). Configure each pump with its assigned address and baud rate as described in the Pump Settings section of this Guide.



NOTE: Once communication is established, if you manipulate the touchscreen, you must reestablish communication <CR>.



NOTE: When daisy-chaining using the RJ-11 option, all pumps must use the same baud rate. Values above 38400 are recommended.



NOTE: If you are using the optional RJ-11 connections for daisy-chaining, the connection from the computer must also come through the RJ-11 or RS-232 connectors.



NOTE: System commands and start/stop commands can be executed from method or Quickstart screens. For parameter commands it is necessary to run from Quickstart screen.



NOTE: To maximize communication speed [as fast as 50 ms rate changes]:
 (a) prefix commands with the @ symbol to turn off GUI updates (ex: @irate 100 u/m)
 (b) use the 'NVRAM off' command to turn off writes of rate to memory

Using PHD ULTRA™ Pump Chain Commands

Commands may be abbreviated to the first four letters, i.e. address would be abbreviated addr. A space must follow the command if arguments are included.

If the pump address is nonzero, the one or two-digit pump address precedes the command without any separator. For example, to set the infuse rate for pump 12, the command would look like "12irat 3.2 u/m". If the pump address is one digit, it doesn't have to be preceded by a 0. Note that if the USB port is used on a pump with a nonzero address, the pump address doesn't need to be used.

Every line of the response from a pump with a nonzero address is prefixed by the two digit pump address (prefixed with a 0 if necessary) followed by a colon. No colon is used to separate the pump address from the prompt however.

In the command list below, the following convention is used:

{ }	Required parameter
[]	Optional parameter
	Separator between parameter choices
#	Numeric value without preceding zeros
###	Numeric value with preceding zeros
##	A range of values
<cr>	Carriage return

PHD ULTRA™ - Pump Chain Commands (continued)

<lf>	Line feed
<sp>	Space
[prefix]	Pump address prefix in the format #: if the pump address is not zero
<prompt>	Prompt (see below)

The following prompts are returned after a command is executed:

:	The pump is idle
>	The pump is infusing
<	The pump is withdrawing
*	The pump stalled
T*	The target was reached

If the pump is in poll REMOTE mode, there will be no prompts or carriage returns.

If the pump is in poll ON mode, a XON character is added after the prompt.

If the pump address is nonzero, the pump address is prefixed to the prompt without a colon.

In the following list of commands:

- The pump address is prefixed to every response line followed by a colon.
- <lf>[##]<prompt> is the response unless otherwise noted.

Error messages

Error messages are displayed if the entered command cannot be executed for some reason. The error message will take up two lines with the first line being the message type and the second line describing the error itself. The second line may be up to 80 characters long.

COMMAND ERRORS

Command errors are displayed when the command is unrecognized, entered in the wrong mode, or the state of the pump keeps the command from executing (i.e. using the IRUN command if a limit switch is active).

The command error has the following format:

```
<lf>[##:]Command error:<cr>
<lf>[##:]<sp><sp><sp>{error message}<cr>
<lf>[##]<prompt>
```

ARGUMENT ERRORS

Argument errors are displayed when a command argument is unrecognized or out of range. The argument in question will be displayed except in the case of missing arguments.

The argument error has the following format:

```
<lf>[##:]Argument error: [bad argument]<cr>
<lf>[##:]<sp><sp><sp>{error message}<cr>
<lf>[##]<prompt>
```

System commands

ADDRESS

Sets or displays the pump address. Valid range is 0 to 99.

Command format:

address [0-99]

Query response:

<lf>[##:]Pump address is #<cr>

<lf>[##]<prompt>

Notes:

Pumps with an address of 0 are masters, and pumps with an address between 1 and 99 are slaves.

BAUD

Sets or displays the RS232 port baud rate. Valid baud rates are 9600, 19200, 38400, 57600, 115200, 128000, 230400, 256000, 460800, and 921600. Note that some computers may not be able to handle baud rates above 115200.

Command format:

baud [9600 | 19200 | 38400 | 57600 | 115200 | 128000 | 230400 | 256000 | 460800 | 921600]

Query response:

<lf>[##:]# baud<cr>

<lf>[##]<prompt>

Notes:

If this command is entered via RS232, the prompt is displayed at the previous baud rate and then the baud rate is changed.

CATALOG

Displays a catalog of methods stored in the pump.

Command format:

cat

Query response:

<lf>[##:]Method name Size<cr>

<lf>[##:]----- ---<cr>

<lf>[##:]{method name} #<cr> This line is repeated for each file on the disk

<lf><lf>[##:]# file(s) using # steps<cr>

<lf>[##]<prompt>

Notes:

The file size is the number of steps in the method plus one for the file information header.

The last line shows the number of files and the total number of steps being used on the disk.

CMD

Sets or displays the command set. The pump is capable of operating in the ULTRA command set or the legacy Model 22 or PHD 44 command sets. Valid sets are ultra, 22, and 44.

Command format:

```
cmd [{command set}]
```

Query response:

```
<lf>[##:] Ultra<cr>
```

```
<lf>[##]<prompt>
```

or:

```
<lf>[##:] 22<cr>
```

```
<lf>[##]<prompt>
```

or:

```
<lf>[##:] 44<cr>
```

```
<lf>[##]<prompt>
```

CONFIG

Sets or displays the pump configuration.

Command format:

```
config[{config designation}]{value}
```



NOTE: After changing the configuration, the pump must be power cycled.

DELMETHOD

Deletes a method stored in the pump.

Command format:

```
delmethod {method}
```

DIM

Sets or displays the backlight level in percent. Valid range is 0 to 100. Note that specifying 0 will turn the backlight off so that the screen will not be visible.

Command format:

```
dim [0-100]
```

Query response:

```
<lf>[##:] #%<cr>
```

```
<lf>[##]<prompt>
```

ECHO

Sets or displays the RS232/USB echo state. Valid states are on or off.

Command format:

```
echo [on|off]
```

Query response:

```
<lf>[##:] OFF<cr>
```

```
<lf>[##]<prompt>
```

or:

```
<lf>[##:] ON<cr>
```

```
<lf>[##]<prompt>
```

FREE

Displays the number of free method steps left on the disk.

Command format:

free

Query response:

<lf>[##:]# steps used<cr>

<lf>[##:]# steps free<cr>

<lf>[##:]# total steps<cr>

<lf>[##]<prompt>

The number of steps displayed is a four digit number, right justified, and padded with spaces.

FORCE

Sets or displays the infusion force level in percent. Valid range is 1 to 100.

Command format:

force [1-100]

Query response:

<lf>[##:]#%<cr>

<lf>[##]<prompt>

FTSWITCH

Sets or displays the footswitch setting. The footswitch may be used in a toggle on or off mode (momentary), a press to run mode (falling), or a release to run mode (rising).

Command format:

ftswitch [mom|rise|fall]

Query response:

<lf>[##:]Momentary<cr>

<lf>[##]<prompt>

or:

<lf>[##:]Active high<cr>

<lf>[##]<prompt>

or:

<lf>[##:]Active low<cr>

<lf>[##]<prompt>

POLL

Sets or displays the polling mode state.

When polling mode is off, prompts are displayed when an event happens, such as a target being reached.

When polling mode is on, prompts are not displayed when an event happens, and a XON character is output when the pump is ready for another command

When polling mode is in remote mode, the following occurs

- Prompts are not displayed
- Carriage returns are not displayed
- The pump address is displayed even if 0
- Echo is forced off and the echo command is illegal

Command format:

```
poll [on|off|remote]
```

Query response:

```
<lf>[#:] OFF<cr>
```

```
<lf>[#]<prompt>
```

or:

```
<lf>[#:] ON<cr>
```

```
<lf>[#]<prompt><xon>
```

or:

```
[#:] REMOTE<lf>
```

TILT

Calibrates the tilt sensor.

Command format:

```
tilt
```

Query response:

```
<lf>[#:]Calibrating the tilt sensor...<cr>
```

```
<lf>[#:]Tilt calibration value is #<cr>
```

```
<lf>[#]<prompt>
```

TIME

Sets or displays the date and time.

Command format:

```
time [mm/dd/yy] [hh:mm:ss]
```

Query response:

```
<lf>[#:]##/##/## ##:##:## #M<cr>
```

```
<lf>[#]<prompt>
```

The date order format is dependent on the settings made when setting the date from the touch screen. The time format is 24 hours.

SYRMANU

Sets or displays the syringe manufacturer. Quick Start mode only.

Valid 3-character manufacturer codes are shown in the table below.

Typing 'syrm' with no arguments displays the current syringe setting.

Typing 'syrm ?' displays a list of manufacturers with their associated 3-letter code.

Typing 'syrm {code} ?' shows a list of syringe sizes associated with the specified manufacturer.

air	Air-Tite, HSW Norm-Ject
bdg	Becton Dickinson, Glass (all types)
bdp	Becton Dickinson, Plasti-pak
cad	Cadence Science, Micro-Mate Glass
has	Harvard Stainless Steel
hm1	Hamilton 700, Glass
hm2	Hamilton 1000, Glass
hm3	Hamilton 1700, Glass
hm4	Hamilton 7000, Glass
hos	Hoshi
ils	ILS, Glass
nip	Nipro
sge	SGE (Scientific Glass Engineering)
smp	Sherwood-Monoject, Plastic
tej	Terumo Japan, Plastic
top	Top

Command format:

syrm [?]{3 char code}[{volume}ul|ml]

Query response:

<lf>[##:]{manufacturer}, {diameter} mm<cr>

<lf>[##]<prompt>

or:

<lf>[##:]Custom, {diameter} mm<cr>

<lf>[##]<prompt>

or:

<lf>[##:]{code}, {diameter} mm<cr> This line is repeated for each syringe manufacturer.

<lf>[##]<prompt>

or:

<lf>[##:]{volume}, {unit}<cr> This line is repeated for each syringe size.

<lf>[##]<prompt>

VALVE

Displays or sets the valve state. When the valve is set to auto, the motor direction determines the valve state. Valve defaults to Auto on power-up. When set to auto, OFF = Infuse and ON = Refill.

Command format:

valve [on|off|auto]

Query response:

<lf>[##:]On<cr>

<lf>[##]<prompt>

or:

<lf>[##:]Off<cr>

<lf>[##]<prompt>

VER

Displays the short version string.

Command format:

ver

Query response:

<lf>[##:]PHD Ultra #.#.#<cr>

<lf>[##]<prompt>

VERSION

Displays the full version string.

Command format:

version

Query response:

<lf>[##:]Firmware: v#.#.#<cr>

<lf>[##:]Pump address: #<cr>

<lf>[##:]Serial number: C#####<cr>

<lf>[##:]Device ID: #####<cr>

<lf>[##]<prompt>

RUN COMMANDS**IRUN**

Runs the pump in the infuse direction. Quick Start mode only.

Command format:

irun

RRUN

Runs the pump in the opposite direction. Quick Start mode only.

Command format:

rrun

RUN

Simulates a key press of the run button located in the lower right corner of the screen.

Command format:

run

STOP / STP

Stops the pump.

Command formats:

stop

stp

WRUN

Runs the pump in the withdraw direction. Quick Start mode only.

Command format:

wrun

RATE COMMANDS

CRATE

Displays the current rate that the motor is running at. A valid response is returned only in dynamic situations (while the pump is running). Quick Start mode only.

Command format:

crate

Query response:

<lf>[##:]Infusing at # xl/xxx<cr>

<lf>[##]<prompt>

or:

<lf>[##:]Withdrawing at # xl/xxx<cr>

<lf>[##]<prompt>

DIAMETER

Sets or displays the syringe diameter in mm. Quick Start mode only.

Command format:

diameter [{syringe diameter}]

Query response:

<lf>[##:]#.##### mm<cr>

<lf>[##]<prompt>

GANG

Sets or displays the syringe count. Quick Start mode only.

Command format:

gang [{syringe count}]

Query response:

<lf>[##:]# syringes<cr>

<lf>[##]<prompt>

IRAMP

Sets or displays the infusion rates while ramping. Quick Start mode only.

Command format:

```
iramp [{start rate} {start units} {end rate} {end units} {ramp time in seconds}]
```

Query response:

```
<lf>[##:]Ramp not set up.<cr>
```

```
<lf>[##]<prompt>
```

or:

```
<lf>[##:]# xl/xxx to xl/xxx in # seconds<cr>
```

```
<lf>[##]<prompt>
```



NOTE: When using the iramp command, rate/time remaining, on display, will not reflect actual pump rate/time remaining during ramping.

IRATE

Sets or displays the infusion rate. Quick Start mode only. The rate argument may be replaced by “max” or “min” to set the maximum or minimum rate, respectively. “lim” may be used to display the range limits.

Command format:

```
irate [max | min | lim | {rate} {rate units}]
```

Query response:

```
<lf>[##:]# xl/xxx<cr>
```

```
<lf>[##]<prompt>
```

or:

```
<lf>[##:]# xl/xxx to # xl/xxx<cr>
```

```
<lf>[##]<prompt>
```

WRAMP

Sets or displays the withdraw rates while ramping. Quick Start mode only.

Command format:

```
wramp [{start rate} {start units} {end rate} {end units} {ramp time in seconds}]
```

Query response:

```
<lf>[##:]Ramp not set up.<cr>
```

```
<lf>[##]<prompt>
```

or:

```
<lf>[##:]# xl/xxx to # xl/xxx in # seconds<cr>
```

```
<lf>[##]<prompt>
```



NOTE: To clear a ramp, use CTTIME command.

WRATE

Sets or displays the withdraw rate. Quick Start mode only. The rate argument may be replaced by “max” or “min” to set the maximum or minimum rate, respectively. “lim” may be used to display the range limits.

Command format:

```
wrate [max|min|lim|{rate} {rate units}]
```

Query response:

```
<lf>[##:]# xl/xxx<cr>
```

```
<lf>[##]<prompt>
```

or:

```
<lf>[##:]# xl/xxx to # xl/xxx<cr>
```

```
<lf>[##]<prompt>
```



NOTE: For commands requiring rate units, use the following format:

m, u, n, p/h, m, s

Ex: m/m= milliliter/minute

n/s= nanoliter/second

VOLUME COMMANDS

CIVOLUME

Clears the infused volume. Quick Start mode only.

Command format:

```
civolume
```

CTVOLUME

Clears the target volume. Quick Start mode only.

Command format:

```
ctvolume
```

CVOLUME

Clears both the infused and withdrawn volumes. Quick Start mode only.

Command format:

```
cvolume
```

CWVOLUME

Clears the withdrawn volume. Quick Start mode only.

Command format:

```
cwvolume
```

IVOLUME

Displays the infused volume. Quick Start mode only.

Command format:

ivolume

Query response:

<lf>[##:]# x<cr>

<lf>[##]<prompt>

SVOLUME

Sets or displays syringe volume. Quick Start mode only.

Command format:

svolume [{syringe volume} {ul|ml}]

Query response:

<lf>[##:]#.##### ul<cr>

<lf>[##]<prompt>

or:

<lf>[##:]#.##### ml<cr>

<lf>[##]<prompt>

TVOLUME

Sets or displays the target volume. Quick Start mode only.

Command format:

tvolume [{target volume} {volume units}]

Query response:

<lf>[##:]Target volume not set<cr>

<lf>[##]<prompt>

or:

<lf>[##:] # x<cr>

<lf>[##]<prompt>

WVOLUME

Displays the withdrawn volume. Quick Start mode only.

Command format:

wvolume

Query response:

<lf>[##:]# x<cr>

<lf>[##]<prompt>

TIME COMMANDS

CITIME

Clears the infused time. Quick Start mode only.

Command format:

citime

CTIME

Clears both the infused and withdrawn times. Quick Start mode only.

Command format:

ctime

CTTIME

Clears the target time. Quick Start mode only.

Command format:

ctime

CWTIME

Clears the withdrawn time. Quick Start mode only.

Command format:

cwtime

ITIME

Displays the infused time. Quick Start mode only.

Command format:

itime

Query response:

<lf>[##.]# seconds<cr>

<lf>[##]<prompt>

or:

<lf>[##.]###:###:###<cr>

<lf>[##]<prompt>

TTIME

Sets or displays the target time. Quick Start mode only.

Command format:

ttime [{target time}]

Query response:

<lf>[#:]Target time not set<cr>

<lf>[#]<prompt>

or:

<lf>[#:]# seconds<cr>

<lf>[#]<prompt>

or:

<lf>[#:]###:###:###<cr>

<lf>[#]<prompt>

WTIME

Displays the withdrawn time. Quick Start mode only.

Command format:

wtime

Query response:

<lf>[#:]# seconds<cr>

<lf>[#]<prompt>

or:

<lf>[#:]###:###:###<cr>

<lf>[#]<prompt>

DIGITAL I/O COMMANDS**INPUT**

Reads and displays the trigger input port status.

Command format:

input

Query response:

<lf>[#:]Low.<cr>

<lf>[#]<prompt>

or:

<lf>[#:]High.<cr>

<lf>[#]<prompt>

OUTPUT

Sets the level on one of the output ports.

Command format:
output {1|2} {high|low}

SYNC

Sets the level on the sync port.

Command format:
sync {high|low}

INTERNAL COMMANDS

STATUS

Displays the raw status for use with a controlling computer.

Command format:
status

The output is in three integer fields and one flag field, all separated by spaces and terminated by a carriage return / linefeed pair. The first integer is the current rate in femtoliters per second. The second integer is the infuse time in milliseconds. The time has a granularity of 1 millisecond. The third integer is the infused volume in femtoliters. All three values are for the current direction.

The flag field consists of six flags.

- Flag one is the motor direction and will be “i or I” if the pump is infusing and “w or W” if the pump is withdrawing. If the letter is lower case, the pump motor is idle. If upper case, the pump motor is running.
- Flag two is the limit switch status. If the infuse limit switch was hit, “i or I” is displayed. If the withdraw limit switch was hit, “w or W” is displayed. If no limit switch was hit or the pump does not have limit switches, “.” is displayed.
- Flag three is the stall status and will be “S” if the pump has stalled. Otherwise it will be “.”.
- Flag four is the trigger input state and will be “T” if high and “.” if low.
- Flag five is the direction port state and will be “i or I” for infuse and “w or W” for withdraw.
- Flag six is the target reached status. It will be “T” if the target time or volume was reached and “.” if not.

Appendices

APPENDIX A: SYRINGE VOLUME/DIAMETER REFERENCE TABLE

<p>Harvard Apparatus Stainless Steel</p> <table border="1"> <thead> <tr> <th>Size</th> <th>Diameter</th> </tr> </thead> <tbody> <tr><td>2.5 ml</td><td>4.851 mm</td></tr> <tr><td>8</td><td>9.525</td></tr> <tr><td>20</td><td>19.13</td></tr> <tr><td>50</td><td>28.6</td></tr> <tr><td>100</td><td>34.9</td></tr> </tbody> </table> <hr/> <p>Air-Tite HSW Norm-Ject</p> <table border="1"> <thead> <tr> <th>Size</th> <th>Diameter</th> </tr> </thead> <tbody> <tr><td>1 ml</td><td>4.69 mm</td></tr> <tr><td>2.5</td><td>9.65</td></tr> <tr><td>5</td><td>12.45</td></tr> <tr><td>10</td><td>15.9</td></tr> <tr><td>20</td><td>20.05</td></tr> <tr><td>30</td><td>22.9</td></tr> <tr><td>50</td><td>29.2</td></tr> </tbody> </table> <hr/> <p>Becton Dickinson 'Plasti-pak'</p> <table border="1"> <thead> <tr> <th>Size</th> <th>Diameter</th> </tr> </thead> <tbody> <tr><td>1 ml</td><td>4.699 mm</td></tr> <tr><td>3</td><td>8.585</td></tr> <tr><td>5</td><td>11.989</td></tr> <tr><td>10</td><td>14.427</td></tr> <tr><td>20</td><td>19.05</td></tr> <tr><td>30</td><td>21.59</td></tr> <tr><td>50</td><td>26.594</td></tr> <tr><td>60</td><td>26.594</td></tr> </tbody> </table> <hr/> <p>Terumo Japan</p> <table border="1"> <thead> <tr> <th>Size</th> <th>Diameter</th> </tr> </thead> <tbody> <tr><td>1 ml tb</td><td>4.70 mm</td></tr> <tr><td>1 ml vc</td><td>6.50 mm</td></tr> <tr><td>2.5</td><td>9.00</td></tr> <tr><td>5</td><td>13.00</td></tr> <tr><td>10</td><td>15.80</td></tr> <tr><td>20</td><td>20.20</td></tr> <tr><td>30</td><td>23.2</td></tr> <tr><td>60</td><td>29.2</td></tr> </tbody> </table>	Size	Diameter	2.5 ml	4.851 mm	8	9.525	20	19.13	50	28.6	100	34.9	Size	Diameter	1 ml	4.69 mm	2.5	9.65	5	12.45	10	15.9	20	20.05	30	22.9	50	29.2	Size	Diameter	1 ml	4.699 mm	3	8.585	5	11.989	10	14.427	20	19.05	30	21.59	50	26.594	60	26.594	Size	Diameter	1 ml tb	4.70 mm	1 ml vc	6.50 mm	2.5	9.00	5	13.00	10	15.80	20	20.20	30	23.2	60	29.2	<p>SGE Scientific Glass Engineering</p> <table border="1"> <thead> <tr> <th>Size</th> <th>Diameter</th> </tr> </thead> <tbody> <tr><td>5 μl</td><td>0.343 mm</td></tr> <tr><td>10</td><td>0.485</td></tr> <tr><td>25</td><td>0.728</td></tr> <tr><td>50</td><td>1.03</td></tr> <tr><td>100</td><td>1.457</td></tr> <tr><td>250</td><td>2.303</td></tr> <tr><td>500</td><td>3.257</td></tr> </tbody> </table> <table border="1"> <thead> <tr> <th>Size</th> <th>Diameter</th> </tr> </thead> <tbody> <tr><td>1 ml</td><td>4.606 mm</td></tr> <tr><td>2.5</td><td>7.284</td></tr> <tr><td>5</td><td>10.301</td></tr> <tr><td>10</td><td>14.567</td></tr> <tr><td>25</td><td>23</td></tr> <tr><td>50</td><td>27.5</td></tr> <tr><td>100</td><td>35</td></tr> </tbody> </table> <hr/> <p>Hamilton Glass - All Types</p> <table border="1"> <thead> <tr> <th>Size</th> <th>Diameter</th> </tr> </thead> <tbody> <tr><td>0.5 μl</td><td>0.103 mm</td></tr> <tr><td>1</td><td>0.1457</td></tr> <tr><td>2</td><td>0.206</td></tr> <tr><td>5</td><td>0.3302*</td></tr> <tr><td>5</td><td>0.343**</td></tr> <tr><td>10</td><td>0.485**</td></tr> <tr><td>10</td><td>0.461***</td></tr> <tr><td>25</td><td>0.729</td></tr> <tr><td>50</td><td>1.03</td></tr> <tr><td>100</td><td>1.457</td></tr> <tr><td>250</td><td>2.304</td></tr> <tr><td>500</td><td>3.256</td></tr> </tbody> </table> <table border="1"> <thead> <tr> <th>Size</th> <th>Diameter</th> </tr> </thead> <tbody> <tr><td>1 ml</td><td>4.608 mm</td></tr> <tr><td>1.25</td><td>5.151</td></tr> <tr><td>2.5</td><td>7.285</td></tr> <tr><td>5</td><td>10.3</td></tr> <tr><td>10</td><td>14.567</td></tr> <tr><td>25</td><td>23.033</td></tr> <tr><td>50</td><td>32.573</td></tr> <tr><td>100</td><td>32.573</td></tr> </tbody> </table> <p>* = Series 7000 ** = Series 700 *** = Series 1700</p>	Size	Diameter	5 μ l	0.343 mm	10	0.485	25	0.728	50	1.03	100	1.457	250	2.303	500	3.257	Size	Diameter	1 ml	4.606 mm	2.5	7.284	5	10.301	10	14.567	25	23	50	27.5	100	35	Size	Diameter	0.5 μ l	0.103 mm	1	0.1457	2	0.206	5	0.3302*	5	0.343**	10	0.485**	10	0.461***	25	0.729	50	1.03	100	1.457	250	2.304	500	3.256	Size	Diameter	1 ml	4.608 mm	1.25	5.151	2.5	7.285	5	10.3	10	14.567	25	23.033	50	32.573	100	32.573	<p>Cadence Science, Inc. Formerly Popper & Sons MICRO-MATE Glass</p> <table border="1"> <thead> <tr> <th>Size</th> <th>Diameter</th> </tr> </thead> <tbody> <tr><td>0.25 ml</td><td>3.47 mm</td></tr> <tr><td>0.5</td><td>3.62</td></tr> <tr><td>1</td><td>4.82</td></tr> <tr><td>2</td><td>8.91</td></tr> <tr><td>3</td><td>8.91</td></tr> <tr><td>5</td><td>11.71</td></tr> <tr><td>10</td><td>14.65</td></tr> <tr><td>20</td><td>19.56</td></tr> <tr><td>30</td><td>22.7</td></tr> <tr><td>50</td><td>28.02</td></tr> <tr><td>100</td><td>35.7</td></tr> </tbody> </table> <hr/> <p>Becton Dickinson Glass-All Types</p> <table border="1"> <thead> <tr> <th>Size</th> <th>Diameter</th> </tr> </thead> <tbody> <tr><td>0.5 ml</td><td>4.64 mm</td></tr> <tr><td>1</td><td>4.64</td></tr> <tr><td>2.5</td><td>8.66</td></tr> <tr><td>5</td><td>11.86</td></tr> <tr><td>10</td><td>14.34</td></tr> <tr><td>20</td><td>19.13</td></tr> <tr><td>30</td><td>22.7</td></tr> <tr><td>50</td><td>28.6</td></tr> <tr><td>100</td><td>34.9</td></tr> </tbody> </table> <hr/> <p>Sherwood-Monoject Plastic</p> <table border="1"> <thead> <tr> <th>Size</th> <th>Diameter</th> </tr> </thead> <tbody> <tr><td>1 ml</td><td>4.674 mm</td></tr> <tr><td>3</td><td>8.865</td></tr> <tr><td>6</td><td>12.600</td></tr> <tr><td>12</td><td>15.621</td></tr> <tr><td>20</td><td>20.142</td></tr> <tr><td>35</td><td>23.571</td></tr> <tr><td>60</td><td>26.568</td></tr> <tr><td>140</td><td>37.948</td></tr> </tbody> </table>	Size	Diameter	0.25 ml	3.47 mm	0.5	3.62	1	4.82	2	8.91	3	8.91	5	11.71	10	14.65	20	19.56	30	22.7	50	28.02	100	35.7	Size	Diameter	0.5 ml	4.64 mm	1	4.64	2.5	8.66	5	11.86	10	14.34	20	19.13	30	22.7	50	28.6	100	34.9	Size	Diameter	1 ml	4.674 mm	3	8.865	6	12.600	12	15.621	20	20.142	35	23.571	60	26.568	140	37.948	<p>Hosbi</p> <table border="1"> <thead> <tr> <th>Size</th> <th>Diameter</th> </tr> </thead> <tbody> <tr><td>1 ml</td><td>6.50 mm</td></tr> <tr><td>2</td><td>9.10</td></tr> <tr><td>3</td><td>10.00</td></tr> <tr><td>5</td><td>12.60</td></tr> <tr><td>10</td><td>15.10</td></tr> <tr><td>20</td><td>20.45</td></tr> <tr><td>30</td><td>22.50</td></tr> <tr><td>50</td><td>25.60</td></tr> <tr><td>100</td><td>34.00</td></tr> </tbody> </table> <hr/> <p>ILS Glass</p> <table border="1"> <thead> <tr> <th>Size</th> <th>Diameter</th> </tr> </thead> <tbody> <tr><td>250 μl</td><td>2.303 mm</td></tr> <tr><td>500</td><td>3.260</td></tr> <tr><td>1 ml</td><td>4.606 mm</td></tr> <tr><td>2.5</td><td>7.280</td></tr> <tr><td>5</td><td>10.300</td></tr> <tr><td>10</td><td>14.567</td></tr> <tr><td>25</td><td>23.032</td></tr> <tr><td>50</td><td>32.573</td></tr> <tr><td>100</td><td>32.573</td></tr> </tbody> </table> <hr/> <p>Top</p> <table border="1"> <thead> <tr> <th>Size</th> <th>Diameter</th> </tr> </thead> <tbody> <tr><td>1 ml</td><td>6.40 mm</td></tr> <tr><td>2.5</td><td>9.30</td></tr> <tr><td>5</td><td>13.10</td></tr> <tr><td>10</td><td>15.3</td></tr> <tr><td>20</td><td>21.0</td></tr> <tr><td>30</td><td>23.0</td></tr> <tr><td>50</td><td>29.0</td></tr> </tbody> </table> <hr/> <p>NIPRO</p> <table border="1"> <thead> <tr> <th>Size</th> <th>Diameter</th> </tr> </thead> <tbody> <tr><td>1 ml long</td><td>6.6 mm</td></tr> <tr><td>1 ml short</td><td>4.7</td></tr> <tr><td>2.5 ml</td><td>9.0</td></tr> <tr><td>5</td><td>13.0</td></tr> <tr><td>10</td><td>15.8</td></tr> <tr><td>20</td><td>20.1</td></tr> <tr><td>30</td><td>23.2</td></tr> <tr><td>50</td><td>29.1</td></tr> </tbody> </table>	Size	Diameter	1 ml	6.50 mm	2	9.10	3	10.00	5	12.60	10	15.10	20	20.45	30	22.50	50	25.60	100	34.00	Size	Diameter	250 μ l	2.303 mm	500	3.260	1 ml	4.606 mm	2.5	7.280	5	10.300	10	14.567	25	23.032	50	32.573	100	32.573	Size	Diameter	1 ml	6.40 mm	2.5	9.30	5	13.10	10	15.3	20	21.0	30	23.0	50	29.0	Size	Diameter	1 ml long	6.6 mm	1 ml short	4.7	2.5 ml	9.0	5	13.0	10	15.8	20	20.1	30	23.2	50	29.1
Size	Diameter																																																																																																																																																																																																																																																																																						
2.5 ml	4.851 mm																																																																																																																																																																																																																																																																																						
8	9.525																																																																																																																																																																																																																																																																																						
20	19.13																																																																																																																																																																																																																																																																																						
50	28.6																																																																																																																																																																																																																																																																																						
100	34.9																																																																																																																																																																																																																																																																																						
Size	Diameter																																																																																																																																																																																																																																																																																						
1 ml	4.69 mm																																																																																																																																																																																																																																																																																						
2.5	9.65																																																																																																																																																																																																																																																																																						
5	12.45																																																																																																																																																																																																																																																																																						
10	15.9																																																																																																																																																																																																																																																																																						
20	20.05																																																																																																																																																																																																																																																																																						
30	22.9																																																																																																																																																																																																																																																																																						
50	29.2																																																																																																																																																																																																																																																																																						
Size	Diameter																																																																																																																																																																																																																																																																																						
1 ml	4.699 mm																																																																																																																																																																																																																																																																																						
3	8.585																																																																																																																																																																																																																																																																																						
5	11.989																																																																																																																																																																																																																																																																																						
10	14.427																																																																																																																																																																																																																																																																																						
20	19.05																																																																																																																																																																																																																																																																																						
30	21.59																																																																																																																																																																																																																																																																																						
50	26.594																																																																																																																																																																																																																																																																																						
60	26.594																																																																																																																																																																																																																																																																																						
Size	Diameter																																																																																																																																																																																																																																																																																						
1 ml tb	4.70 mm																																																																																																																																																																																																																																																																																						
1 ml vc	6.50 mm																																																																																																																																																																																																																																																																																						
2.5	9.00																																																																																																																																																																																																																																																																																						
5	13.00																																																																																																																																																																																																																																																																																						
10	15.80																																																																																																																																																																																																																																																																																						
20	20.20																																																																																																																																																																																																																																																																																						
30	23.2																																																																																																																																																																																																																																																																																						
60	29.2																																																																																																																																																																																																																																																																																						
Size	Diameter																																																																																																																																																																																																																																																																																						
5 μ l	0.343 mm																																																																																																																																																																																																																																																																																						
10	0.485																																																																																																																																																																																																																																																																																						
25	0.728																																																																																																																																																																																																																																																																																						
50	1.03																																																																																																																																																																																																																																																																																						
100	1.457																																																																																																																																																																																																																																																																																						
250	2.303																																																																																																																																																																																																																																																																																						
500	3.257																																																																																																																																																																																																																																																																																						
Size	Diameter																																																																																																																																																																																																																																																																																						
1 ml	4.606 mm																																																																																																																																																																																																																																																																																						
2.5	7.284																																																																																																																																																																																																																																																																																						
5	10.301																																																																																																																																																																																																																																																																																						
10	14.567																																																																																																																																																																																																																																																																																						
25	23																																																																																																																																																																																																																																																																																						
50	27.5																																																																																																																																																																																																																																																																																						
100	35																																																																																																																																																																																																																																																																																						
Size	Diameter																																																																																																																																																																																																																																																																																						
0.5 μ l	0.103 mm																																																																																																																																																																																																																																																																																						
1	0.1457																																																																																																																																																																																																																																																																																						
2	0.206																																																																																																																																																																																																																																																																																						
5	0.3302*																																																																																																																																																																																																																																																																																						
5	0.343**																																																																																																																																																																																																																																																																																						
10	0.485**																																																																																																																																																																																																																																																																																						
10	0.461***																																																																																																																																																																																																																																																																																						
25	0.729																																																																																																																																																																																																																																																																																						
50	1.03																																																																																																																																																																																																																																																																																						
100	1.457																																																																																																																																																																																																																																																																																						
250	2.304																																																																																																																																																																																																																																																																																						
500	3.256																																																																																																																																																																																																																																																																																						
Size	Diameter																																																																																																																																																																																																																																																																																						
1 ml	4.608 mm																																																																																																																																																																																																																																																																																						
1.25	5.151																																																																																																																																																																																																																																																																																						
2.5	7.285																																																																																																																																																																																																																																																																																						
5	10.3																																																																																																																																																																																																																																																																																						
10	14.567																																																																																																																																																																																																																																																																																						
25	23.033																																																																																																																																																																																																																																																																																						
50	32.573																																																																																																																																																																																																																																																																																						
100	32.573																																																																																																																																																																																																																																																																																						
Size	Diameter																																																																																																																																																																																																																																																																																						
0.25 ml	3.47 mm																																																																																																																																																																																																																																																																																						
0.5	3.62																																																																																																																																																																																																																																																																																						
1	4.82																																																																																																																																																																																																																																																																																						
2	8.91																																																																																																																																																																																																																																																																																						
3	8.91																																																																																																																																																																																																																																																																																						
5	11.71																																																																																																																																																																																																																																																																																						
10	14.65																																																																																																																																																																																																																																																																																						
20	19.56																																																																																																																																																																																																																																																																																						
30	22.7																																																																																																																																																																																																																																																																																						
50	28.02																																																																																																																																																																																																																																																																																						
100	35.7																																																																																																																																																																																																																																																																																						
Size	Diameter																																																																																																																																																																																																																																																																																						
0.5 ml	4.64 mm																																																																																																																																																																																																																																																																																						
1	4.64																																																																																																																																																																																																																																																																																						
2.5	8.66																																																																																																																																																																																																																																																																																						
5	11.86																																																																																																																																																																																																																																																																																						
10	14.34																																																																																																																																																																																																																																																																																						
20	19.13																																																																																																																																																																																																																																																																																						
30	22.7																																																																																																																																																																																																																																																																																						
50	28.6																																																																																																																																																																																																																																																																																						
100	34.9																																																																																																																																																																																																																																																																																						
Size	Diameter																																																																																																																																																																																																																																																																																						
1 ml	4.674 mm																																																																																																																																																																																																																																																																																						
3	8.865																																																																																																																																																																																																																																																																																						
6	12.600																																																																																																																																																																																																																																																																																						
12	15.621																																																																																																																																																																																																																																																																																						
20	20.142																																																																																																																																																																																																																																																																																						
35	23.571																																																																																																																																																																																																																																																																																						
60	26.568																																																																																																																																																																																																																																																																																						
140	37.948																																																																																																																																																																																																																																																																																						
Size	Diameter																																																																																																																																																																																																																																																																																						
1 ml	6.50 mm																																																																																																																																																																																																																																																																																						
2	9.10																																																																																																																																																																																																																																																																																						
3	10.00																																																																																																																																																																																																																																																																																						
5	12.60																																																																																																																																																																																																																																																																																						
10	15.10																																																																																																																																																																																																																																																																																						
20	20.45																																																																																																																																																																																																																																																																																						
30	22.50																																																																																																																																																																																																																																																																																						
50	25.60																																																																																																																																																																																																																																																																																						
100	34.00																																																																																																																																																																																																																																																																																						
Size	Diameter																																																																																																																																																																																																																																																																																						
250 μ l	2.303 mm																																																																																																																																																																																																																																																																																						
500	3.260																																																																																																																																																																																																																																																																																						
1 ml	4.606 mm																																																																																																																																																																																																																																																																																						
2.5	7.280																																																																																																																																																																																																																																																																																						
5	10.300																																																																																																																																																																																																																																																																																						
10	14.567																																																																																																																																																																																																																																																																																						
25	23.032																																																																																																																																																																																																																																																																																						
50	32.573																																																																																																																																																																																																																																																																																						
100	32.573																																																																																																																																																																																																																																																																																						
Size	Diameter																																																																																																																																																																																																																																																																																						
1 ml	6.40 mm																																																																																																																																																																																																																																																																																						
2.5	9.30																																																																																																																																																																																																																																																																																						
5	13.10																																																																																																																																																																																																																																																																																						
10	15.3																																																																																																																																																																																																																																																																																						
20	21.0																																																																																																																																																																																																																																																																																						
30	23.0																																																																																																																																																																																																																																																																																						
50	29.0																																																																																																																																																																																																																																																																																						
Size	Diameter																																																																																																																																																																																																																																																																																						
1 ml long	6.6 mm																																																																																																																																																																																																																																																																																						
1 ml short	4.7																																																																																																																																																																																																																																																																																						
2.5 ml	9.0																																																																																																																																																																																																																																																																																						
5	13.0																																																																																																																																																																																																																																																																																						
10	15.8																																																																																																																																																																																																																																																																																						
20	20.1																																																																																																																																																																																																																																																																																						
30	23.2																																																																																																																																																																																																																																																																																						
50	29.1																																																																																																																																																																																																																																																																																						

Suggested Force Level Settings for Common Syringes

Syringe Type/Material	Capacity	Force Setting	Common Manufacturer(s)
Plastic Syringes	\leq 20 ml	50%	BD plastic, Sherwood, Airtite, Terumo
	>20 ml	100%	
Stainless Steel	All	100%	Harvard Apparatus
Glass/Glass	\leq 20 ml	20%	Cadence (Popper)
	>20 ml	30%	
Glass/Plastic	\leq 1000 μ l	30%	Hamilton, SGE
	\leq 5 ml	50%	
	>5 ml	100%	

APPENDIX B: STAINLESS STEEL SYRINGES



Harvard High Pressure Stainless Steel Syringes
 Harvard offers a complete line (2.5 to 200 ml) of Stainless Steel Syringes intended for high pressure applications with good resistance to most aggressive liquids. Wetted parts are #316 stainless steel or Viton. Syringes are available in 2.5, 8, 20, 50, 100 and 200 ml sizes with removable replacement tips. The 20 to 200 ml stainless steel syringes offer SWAGELOK® fittings in 1/16, 1/8 and 1/4 inch sizes. A luer lock fitting is also available. The tips are interchangeable for 20 to 200 ml syringes. The 2.5 ml is available with a 1/16 inch SWAGELOK® tip only. The 8 ml offers SWAGELOK® fittings in 1/16 or 1/8 inch sizes.

Cat No	Product
	Replacement Parts (20 to 200 ml)
5013-089	Chemraz® O-Ring 20 ml
5013-090	Chemraz® O-Ring 50 ml
5013-091	Chemraz® O-Ring 100 ml
5013-092	Chemraz® O-Ring 200 ml
5013-109	Chemraz® Tip Seal O-Ring, sizes 20-200 ml
72-2472	Replacement Viton O-Ring 20 ml, pkg. of 10
72-2473	Replacement Viton O-Ring 50 ml, pkg. of 10
72-2474	Replacement Viton O-Ring 100 ml, pkg. of 10
72-2475	Replacement Viton O-Ring 200 ml, pkg. of 10
72-2616	Replacement Viton Tip Seal O-Ring, sizes 20-200 ml, pkg. of 20
72-2617	Stainless Steel Plunger Button to Adapt Syringe for Use with PHD 22/2000 HVP with Triple S Clamp (Required for 50 ml and 100 ml syringes only)

All stainless steel syringes are constructed entirely of #316 stainless steel. The 20 to 200 ml stainless steel syringes come standard with two Viton O-rings for the barrel and one for the tip. These Viton O-ring seals insure against leakage. These syringes are guaranteed to be leak free for pressures up to 750 psi.

The 2.5 ml stainless steel syringe contains one Perfluoroelastomer O-ring seal on the tip and one Bal-Seal™ on the barrel. The 8 ml stainless steel syringe contains two Perfluoroelastomer O-ring seals and two Teflon O-Ring seals on the barrel, and a Perfluoroelastomers O-ring on the tip. These syringes were designed to utilize the high forces available in our syringe pumps to produce pressures up to 7500 psi and 1500 psi respectively.

All syringes are supplied with inside diameter dimensions for use with Harvard microprocessor controlled pumps and rate charts for use with older "classic" pumps. Replacement Viton O-rings are available, as are more chemically resistant Perfluoroelastomer O-rings.

High Pressure Stainless Steel Syringes				
Syringe Size	With SWAGLOK		With Luer Lock	
	Diameter 1/16 inch	Diameter 1/8 inch	Diameter 1/4 inch	
2.5 ml	70-2269	N/A	N/A	N/A
8 ml	70-2267	70-2268	N/A	N/A
20 ml	70-2251	70-2252	70-2253	70-2254
50 ml	70-2255	70-2256	70-2257	70-2258
100 ml	70-2259	70-2260	70-2261	70-2262
200 ml	70-2263	70-2264	70-2265	70-2266
Replacement Tips, Furnished with Sealing O-Ring				
2.5 ml	70-2246	N/A	N/A	N/A
8 ml	70-2246	70-2245	N/A	N/A
20 ml to 200 ml	70-2247	70-2248	70-2249	70-2250

APPENDIX C: MIN/MAX FLOW RATE

Nominal Minimum/Maximum Flow Rates for Various Syringes. (Actual Limits will vary depending on syringe manufacturer)					
Syringe Size	Syringe ID	Minimum Rate	Units	Maximum Rate	Units
0.5 μ l	0.103 mm	1.50000	pl/min	1.59133	μ l/min
1 μ l	0.1457 mm	3.06000	pl/min	3.18423	μ l/min
2 μ l	0.206 mm	6.12000	pl/min	6.36532	μ l/min
5 μ l	0.343 mm	16.9800	pl/min	17.6471	μ l/min
10 μ l	0.485 mm	33.9600	pl/min	35.2833	μ l/min
25 μ l	0.729 mm	76.7400	pl/min	79.7151	μ l/min
50 μ l	1.030 mm	153.180	pl/min	159.133	μ l/min
100 μ l	1.457 mm	306.600	pl/min	318.423	μ l/min
250 μ l	2.304 mm	766.740	pl/min	796.252	μ l/min
500 μ l	3.256 mm	1.53126	nl/min	1.59021	ml/min
1 ml	4.608 mm	3.06702	nl/min	3.18501	ml/min
1 ml	4.699 mm	3.18936	nl/min	3.31205	ml/min
2.5 ml	4.851 mm	3.39900	nl/min	3.52979	ml/min
3 ml	8.585 mm	10.6457	nl/min	11.0552	ml/min
5 ml	11.989 mm	20.7616	nl/min	21.5601	ml/min
8 ml	9.525 mm	13.1046	nl/min	13.6087	ml/min
10 ml	14.427 mm	30.0640	nl/min	31.2204	ml/min
20 ml	19.050 mm	52.4186	nl/min	54.4347	ml/min
30 ml	21.590 mm	67.3288	nl/min	69.9183	ml/min
50 ml	26.594 mm	102.156	nl/min	106.085	ml/min
100 ml	35.700 mm	184.091	nl/min	191.171	ml/min
140 ml	37.948 mm	208.005	nl/min	216.005	ml/min

APPENDIX D: SYRINGE HOLDER OPTIONS

Mounting a 4x140 Multi-Rack

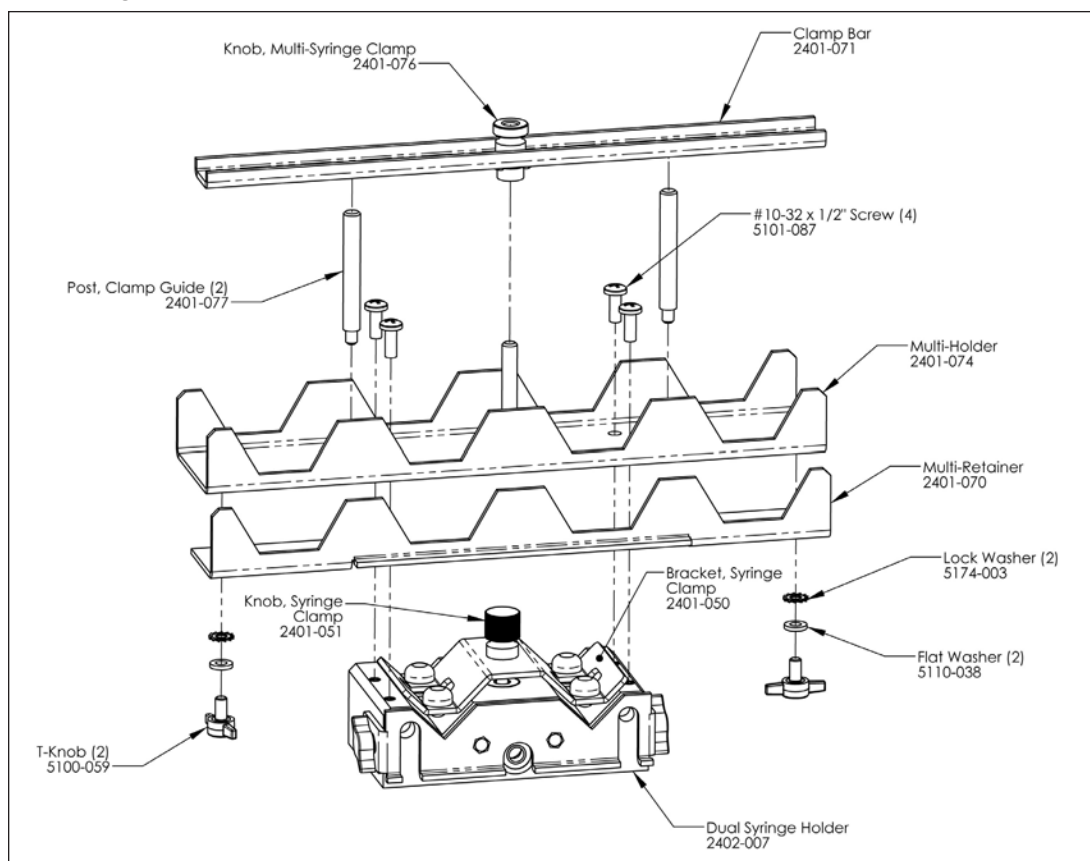

4x140 Multi-Rack Syringe Holder Assembly.

1. Remove the four Set Screws from Syringe Holder using the provided hex key.
2. Remove Syringe Clamp bracket from the Syringe Holder by unscrewing knob.
3. Place the Multi-Holder assembly on the Dual Syringe Holder and attach using four #10-32 x 1/2" Screws.
4. Attach Clamp Bar by screwing the Multi-Syringe Clamp Knob into the threaded bar attached to the Multi-Holder.

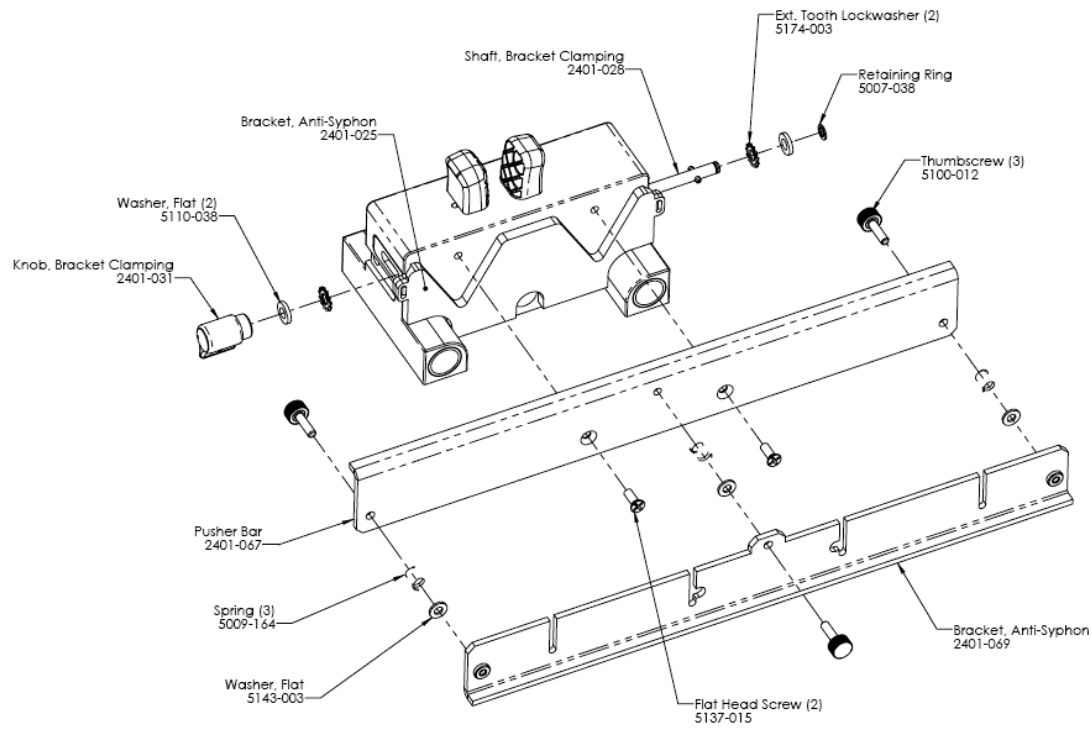

4x140 Multi-Rack Pusher Block Assembly.

1. Remove Dual Syringe Anti-Syphon Bracket by unscrewing the Bracket Clamping Knob completely and removing the Bracket Clamping Shaft.
2. Attach the Pusher Bar assembly to the Pusher Block using two flat head screws.

Mounting a 6/10 Multi-Rack

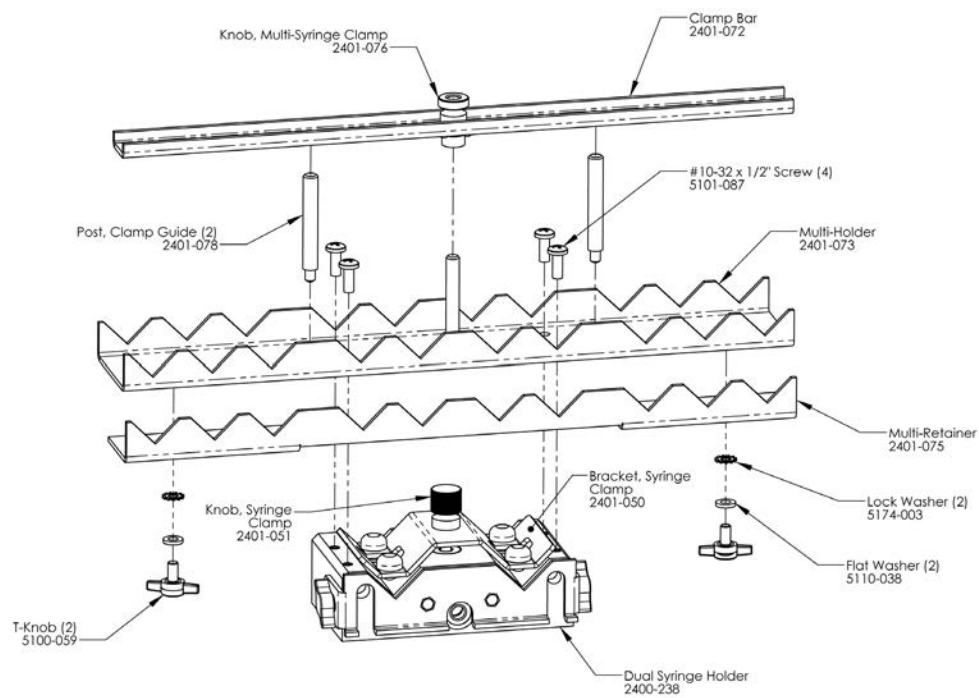

6/10 Multi-Rack Syringe Holder Assembly.

1. Remove the four Set Screws from Syringe Holder using the provided hex key.
2. Remove Syringe Clamp bracket from the Syringe Holder by unscrewing knob.
3. Place the Multi-Holder assembly on the Dual Syringe Holder and attach using four #10-32 x 1/2" Screws.
4. Attach Clamp Bar by screwing the Multi-Syringe Clamp Knob into the threaded bar attached to the Multi-Holder.

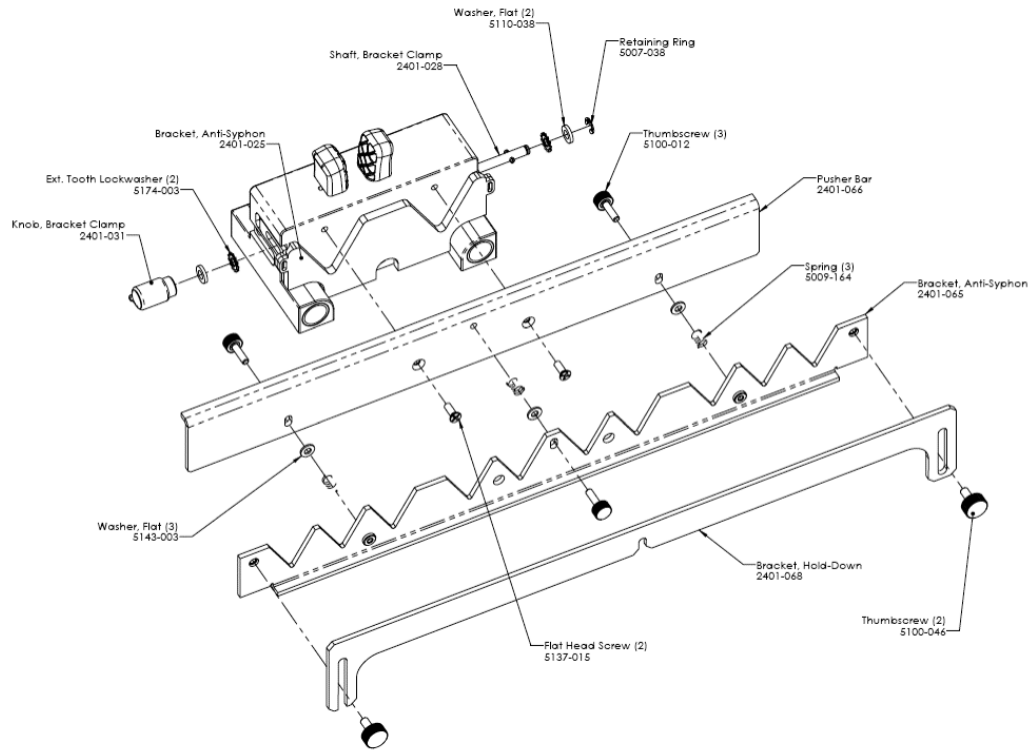

6/10 Multi-Rack Pusher Block Assembly.

1. Remove Dual Syringe Anti-Syphon Bracket by unscrewing the Bracket Clamping Knob completely and removing the Bracket Clamping Shaft.
2. Attach the Pusher Bar assembly to the Pusher Block using two flat head screws.

Syringe Loading – 4 x 140 & 6/10 Multi-Racks

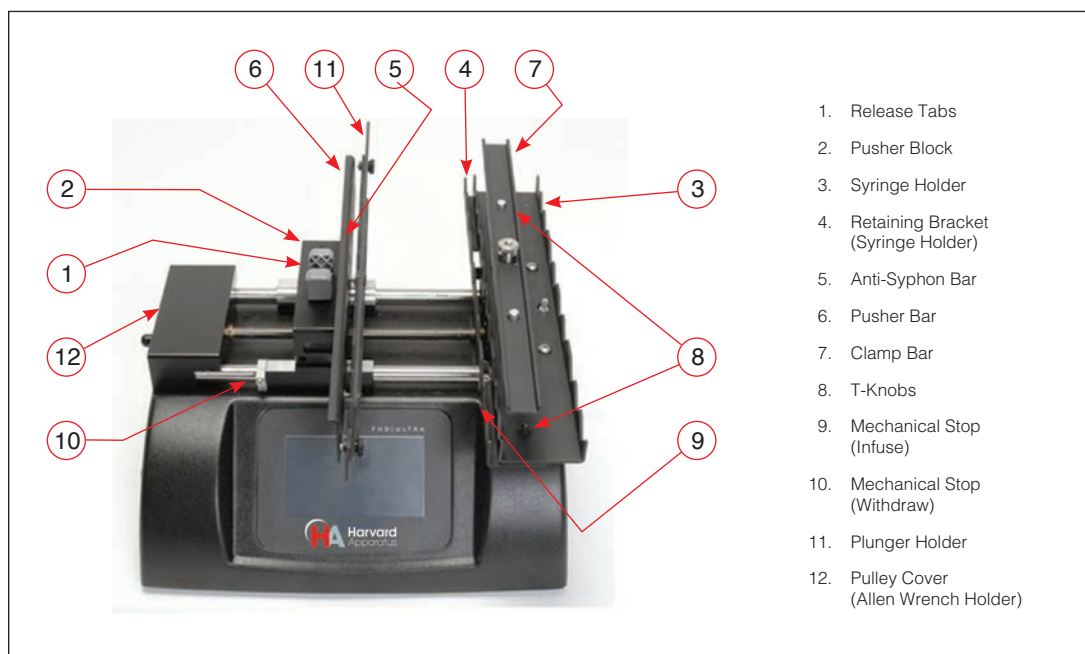

Front view of PHD ULTRA™ with 6/10 Multi-Rack showing controls for multi-rack syringe loading.



NOTE: Refer to Appendices for additional instructions on assembly of the Harvard Apparatus Multi-Rack Accessory.

1. Raise or remove Clamp Bar (7) by unscrewing thumb screw.
2. Loosen T-Knobs (8) and slide the Retaining Bracket (4) on the Syringe Holder (3) open.
3. Adjust the Pusher Block (2) to the approximate length of the syringe(s) by squeezing the Release Tabs (1) and sliding the Pusher Block into position.
4. Loosen the three thumb screws on the Anti-Syphon Bar (5) to provide enough room for the plunger flange of the syringe(s). If using the 6 x 10 rack, loosen the two thumb screws on the outside of the Plunger Holder (11). Flip the plunger holder open.
5. Place the syringe(s) on the Syringe Holder (3) ensuring that the barrel flanges are within the Syringe Holder's Retaining Bracket (4) and the plunger flanges are between the Pusher Bar (6) and Anti-Syphon Bar (5).



NOTE: If using fewer syringes than the maximum number of syringes, try to place them symmetrically about the lead screw to present a balanced load.

6. Push the Syringe Holder's Retaining Bracket (4) tight against the barrel flanges and tighten into place using the two T-Knobs (8).
7. Tighten the Anti-Syphon Bar (5) using the three thumb screws. If using the 6 x 10 rack, flip the Plunger Holder (11) back into place and secure by tightening thumb screws.
8. Lower or replace the Clamp Bar (7) and tighten thumb screw until Clamp Bar is firm against syringe(s).
9. Squeeze the Release Tabs (1) and move the Pusher Block (2) to the right until the syringe plunger is located as far into the syringe as it will travel.

10. Using the Allen Wrench, located in its holder in the rear of the Pulley Cover (12), loosen the Infusion Mechanical Stop (9) and slide it to the left until it is in contact with the Pusher Block (2). Use the Allen Wrench to tighten it in this position.
11. Squeeze the Release Tabs (1) and move the Pusher Block (2) to the left until the plunger is located just to the left of the maximum volume allowable. Use the Allen Wrench to loosen the refill Mechanical Stop (10) and slide it to the right until it is contact with the Pusher Block (2). Tighten the Withdraw Mechanical Stop (10) and then return the Allen Wrench to its holder (12).



Multi-Rack Configurations.



NOTE: When multiple syringes are loaded it may be difficult to manually move the Pusher Block in order to set the Mechanical Stops. Instead, use a single empty syringe to measure the proper lengths and set both the Infuse and Withdraw Mechanical Stops first. Then use the above procedure to load your syringes.

Mounting a Microliter Multi-Rack

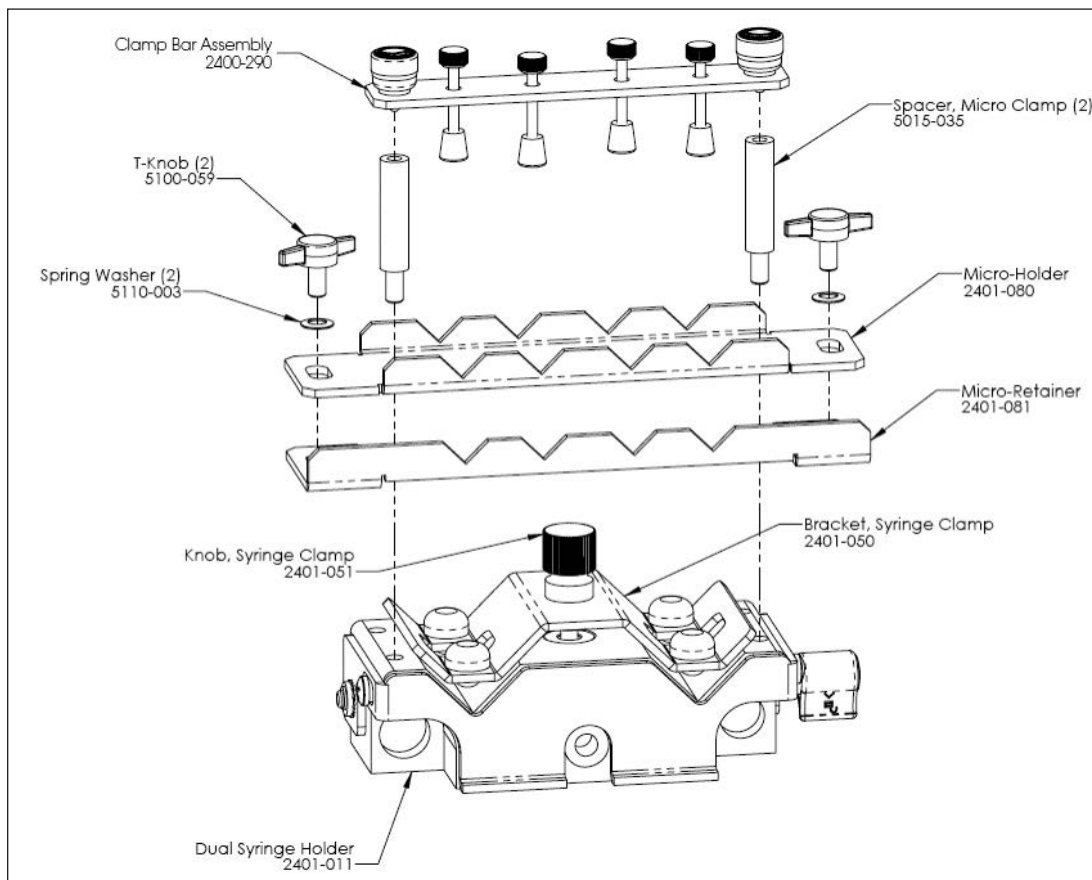

Microliter Multi-Rack Syringe Holder Assembly.

1. Remove the four Set Screws from Syringe Holder using provided hex key.
2. Remove Syringe Clamp and Knob from the Syringe Holder.
3. First assemble the Retaining Bracket to the Micro Holder using the two T-Knobs.
4. Place the assembled Micro Holder onto the syringe holder and screw in the two Standoff Bars.
5. Place the Clamp Bar Assembly onto the Micro Holder by screwing the Thumbscrew Caps into the Standoff Bars.

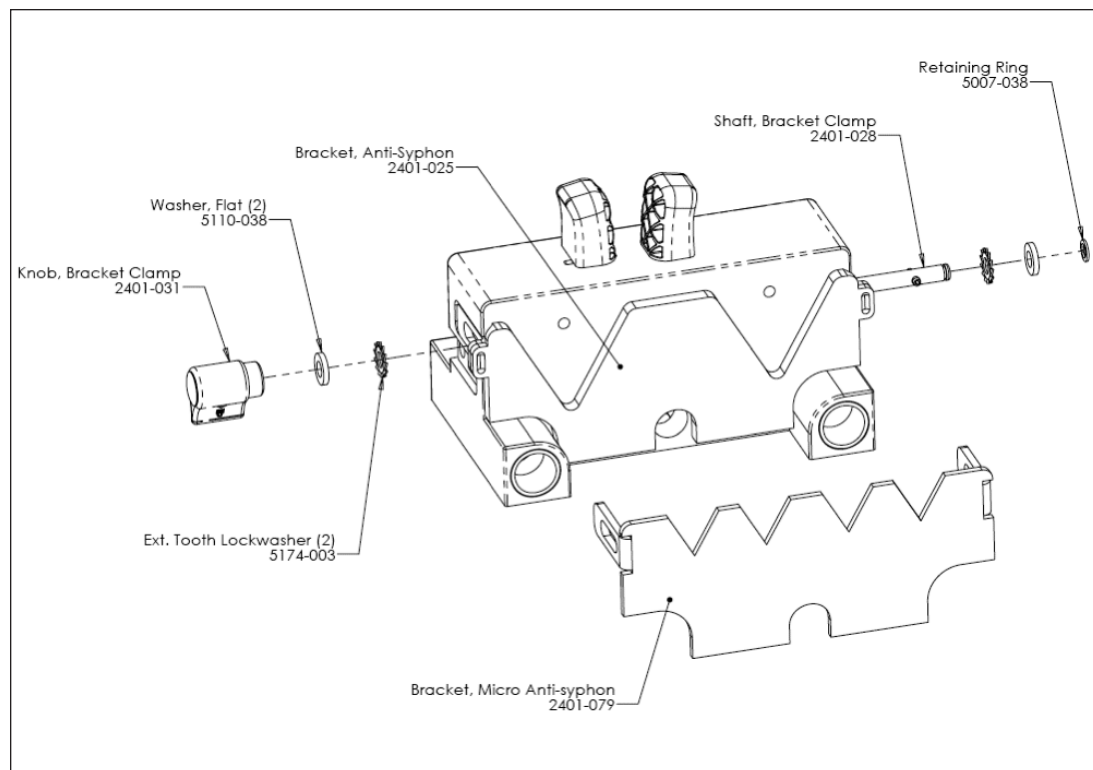

Microliter Multi-Rack Pusher Block Assembly.

1. Remove the Pusher Blocks Retaining Bracket by unscrewing the Bracket Clamping Knob completely and removing the Clamp Shaft.
2. Attach Anti-Syphon Bracket using the Clamp Shaft and Bracket Clamping Knob.

Syringe Loading – Microliter Multi-Rack

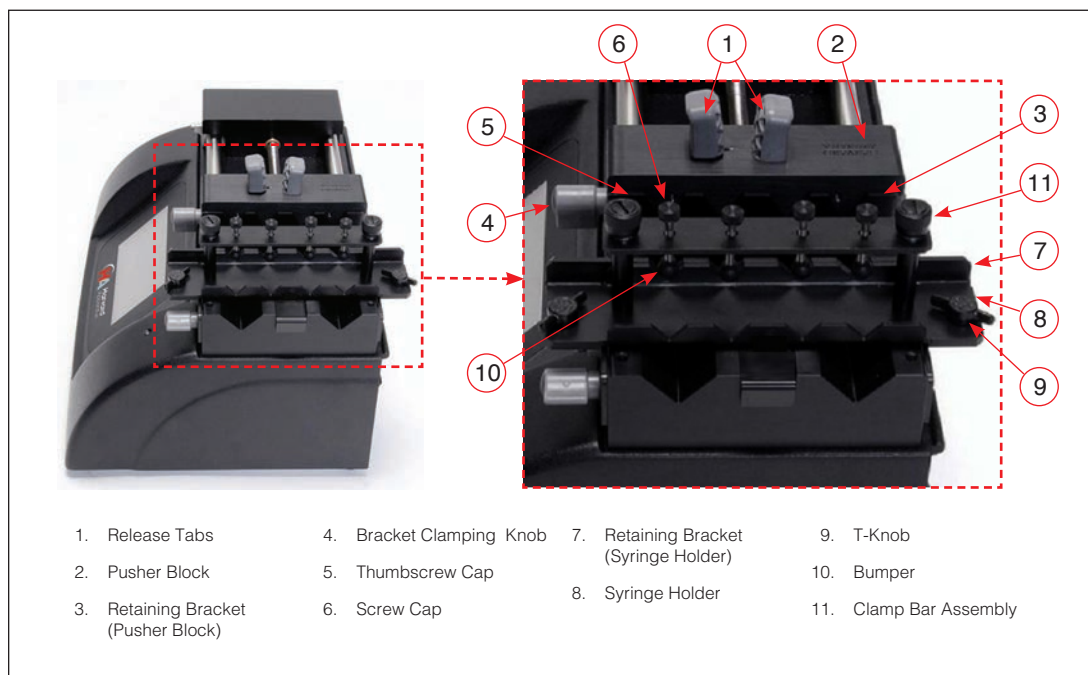

Front view of PHD ULTRA™ showing controls for microliter multi-rack syringe loading.

1. Squeeze Release Tabs (1) and adjust the Pusher Block (2) to the approximate length of the syringe(s).
2. Loosen the Retaining Bracket (3) on the Pusher Block (2) by unscrewing the Bracket Clamping Knob (4).
3. Loosen the Retaining Bracket (7) on the Syringe Holder (8) by unscrewing the two T-Knobs (9).
4. Create room for the syringe(s) by unscrewing the Screw Caps (6) until the Bumpers (10) are at their maximum height.
5. Slide the syringe under the Bumper (10) placing the barrel flange within the Syringe Holder's Retaining Bracket (7) and the plunger flange within the Pusher Block's Retaining Bracket (3).



NOTE: If you are using syringes larger than 1 ml it may be easier to unscrew one of the Thumbscrew Caps (5) and swing the Clamp Bar Assembly (11) to the side, making more room to load the syringe(s). After the syringe(s) are in place swing the Clamp Bar back over the Syringe Holder (8) and reattach the Thumbscrew Cap (5).

6. Lower the bumpers (10) until they are firm against the syringe(s) by screwing in the Screw Cap (6).
7. Push the Syringe Holder's Retaining Bracket (7) tight against the barrel flange and tighten into place using the T-knobs (9). Then push the Pusher Block's Retaining Bracket (3) tight against the plunger flange and tighten using the Bracket Clamping Knob (4).



NOTE: Mechanical stops are set using the same steps as a standard 2 syringe holder.



Microliter Multi-Rack Configuration.

Syringe Loading - Push-Pull Mechanism

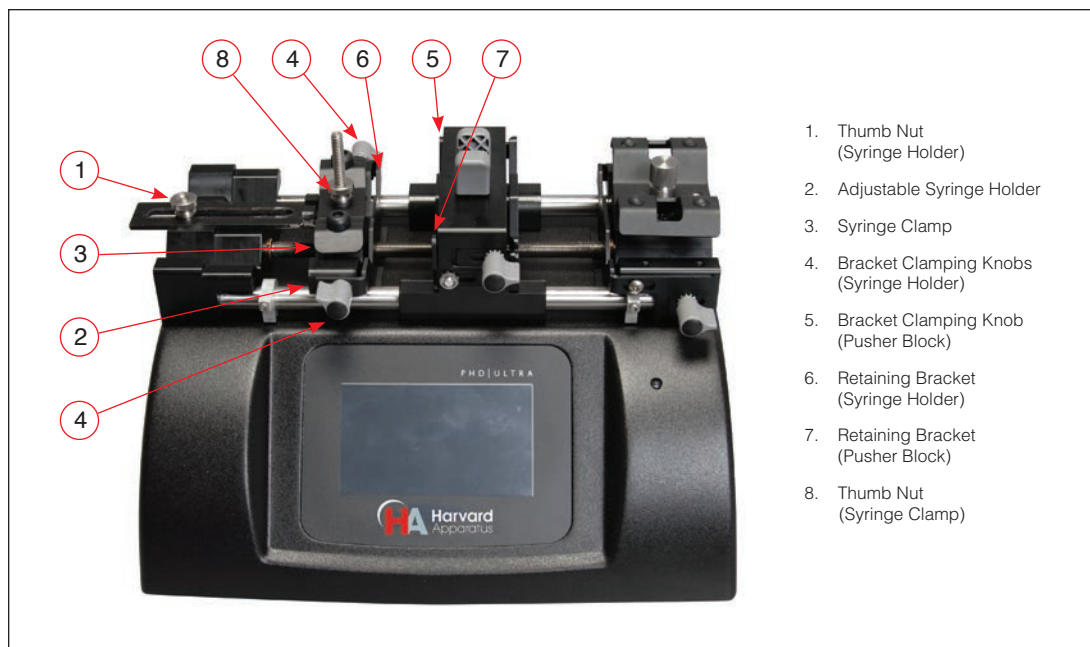

PHD ULTRA™ showing Push-Pull Mechanism installed.

To load syringes on the push/pull pump:

1. Loosen Thumb Nut (1) to release the Adjustable Syringe Holder (2).
2. Loosen the Retaining Bracket (7) on the Pusher Block using the Bracket Clamping Knob (5).
3. Loosen the Retaining Bracket (6) on the Adjustable Syringe Holder (2); note that there are bracket clamping knobs (4) on both the front and rear of this assembly that need to be loosened.
4. Extend Plunger on syringe(s) to maximum capacity.
5. Loosen Thumb Nut (8) and lift Syringe Clamp (3). Place the syringe on the Adjustable Syringe Holder (2), extend as necessary then lock into place by tightening the Thumb Nut (1).
6. Lock the syringe flanges into place by tightening the Retaining Brackets (6,7).
7. Secure the syringe clamp (3) and tighten using the Thumb Nut (8).



PHD ULTRA™ showing syringes installed on both sides of the Pusher Block.



NOTE: For Syringes <10ml you will need to remove the Thumb Nut (8) and then remove and flip over the Syringe Clamp (3).

APPENDIX E: EXTERNAL CONNECTIONS

User I/O Connector Specifications

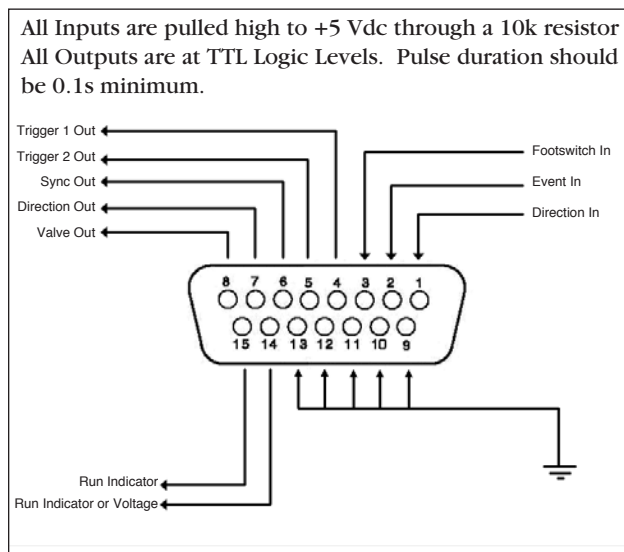

NOTE: For remote pumps, I/O connection must be made at the remote box. (Not the control box)

Pin Assignments:

1. **Direction control input**
 Rising edge sets pump to infuse
 Falling edge sets pump to refill
 2. **Trigger Input**
 Event trigger - falling edge triggers a program event
 3. **Footswitch Input (or Timer)**
 Settable to work as:
 - Momentary switch closure to ground or TTL Logic Low; falling edge toggles between states (run/stop)
 - Starts on rising edge, stops on falling edge
 - Starts on falling edge, stops on rising edge
 4. **Trigger 1 Output**
 TTL Logic Output-Default = Low Control thru method or serial comm
 5. **Trigger 2 Output**
 TTL Logic Output-Default = Low Control thru method or serial comm
 6. **Sync Output**
 TTL Logic Output -
 Rising Edge = Start Infuse
 Falling Edge = Start Refill
 7. **Direction Output**
 TTL Logic Output -
 High = Refill
 Low = Infuse
 8. **Valve Output (controls voltage only)**
 TTL Logic Output -
 High = Valve Actuated
 Low = Valve Off
- NOTE:** Valve follows direction change when set to 'auto'.
- 9-13. **Signal Return / Ground**
 14. **Run Indicator Voltage**
 +5V through a 470 ohm resistor (connect to LED Anode)
 15. **Run Indicator Output**
 TTL Logic Output, active low (low = run) (connect to LED Cathode)

Electrical Specifications:

Inputs:	$V_{IH} \geq 2V$	$I_{IH} \leq 20\mu A$
	$V_{IL} \geq 0.4V$	$I_{IL} \leq 0.5mA$
Outputs:	$V_{OH} \geq 3.8V$	$I_{OH} \leq 6mA$
	$V_{OL} \geq 0.4V$	$I_{OL} \leq 6mA$

Analog Input Option

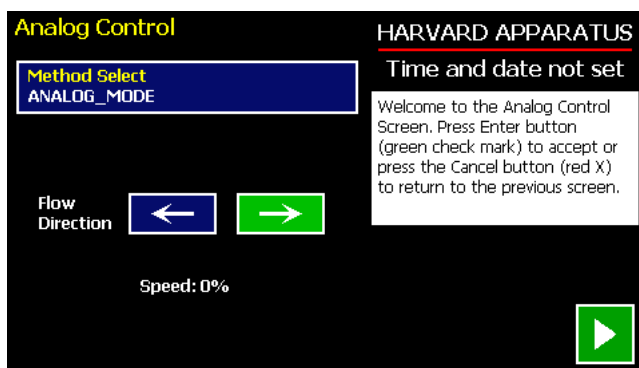

Analog Control Screen.

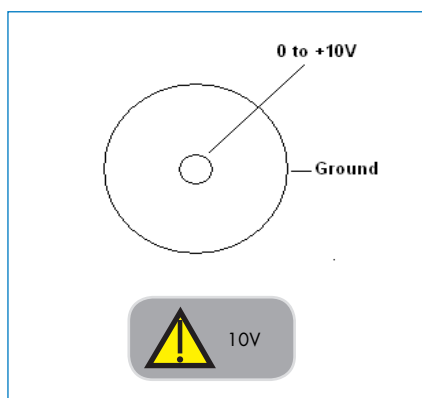

BNC Connector



NOTE: Voltage must be set to 0 VDC when pump is turned on.



NOTE: Although the Analog Mode cycle time is 100 ms, when changing from min to max (or max to min) rates please allow a minimum of 250 ms.



NOTE: Not available on satellite units

USB

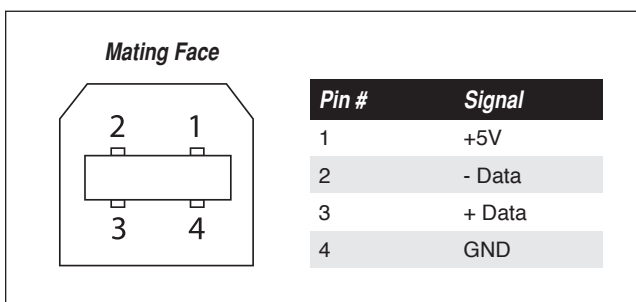

USB Type B Female.

USB VIRTUAL COMMPORT DRIVER INSTALLATION

When you connect the PHD Ultra pump to a computer via USB, Windows will seek to install a driver for communication. The following section details the installation of the Virtual CommPort Driver supplied with the PHD Ultra pump.

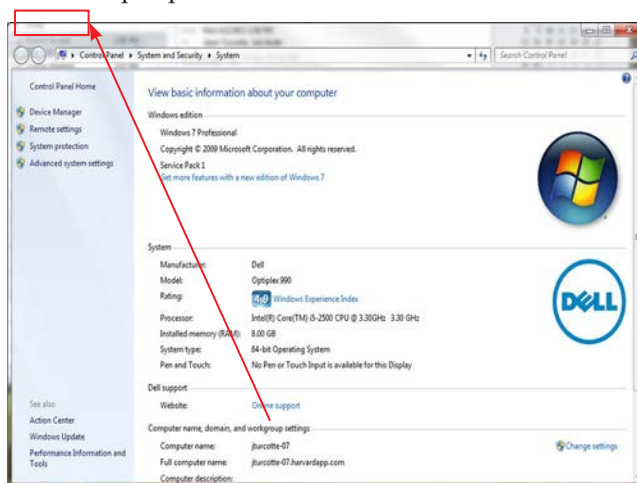

1. Connect the pump to the computer via USB. Open the control panel and select System and Security and then System. Click Device Manager on the left hand menu.

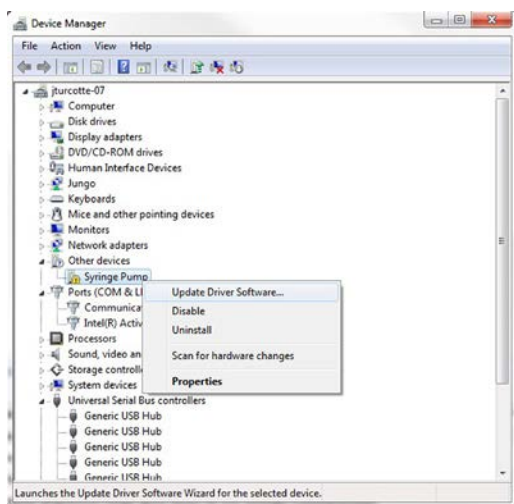

2. Two Flash Update Applications will be displayed in the device manager, under Other Devices. Right click on either of the flash update applications and select Update Driver Software.

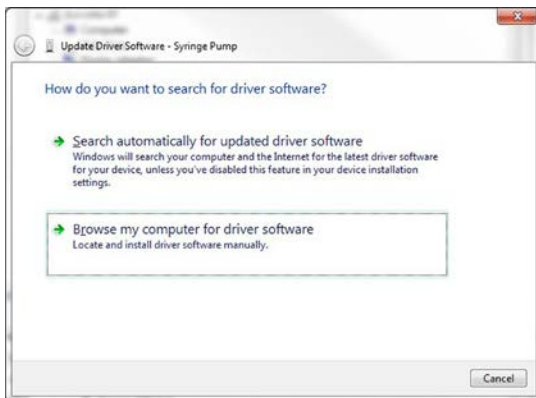

3. Select Browse my computer for driver software.



4. Click Browse and navigate to the pump drivers folder located on the CD supplied with the pump. Select the file Harvard Apparatus USB-CDC.inf. Make sure the Include Subfolders box is checked and then click next.

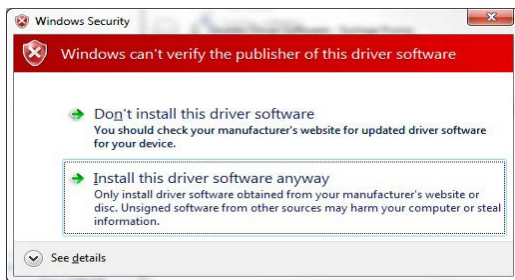

5. If a warning message regarding the driver publisher is displayed, choose Install this driver software anyway.

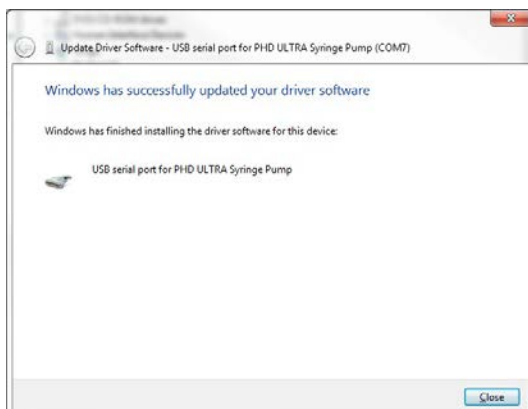

6. Click Close after the software has been successfully installed.

RS-232 Specifications

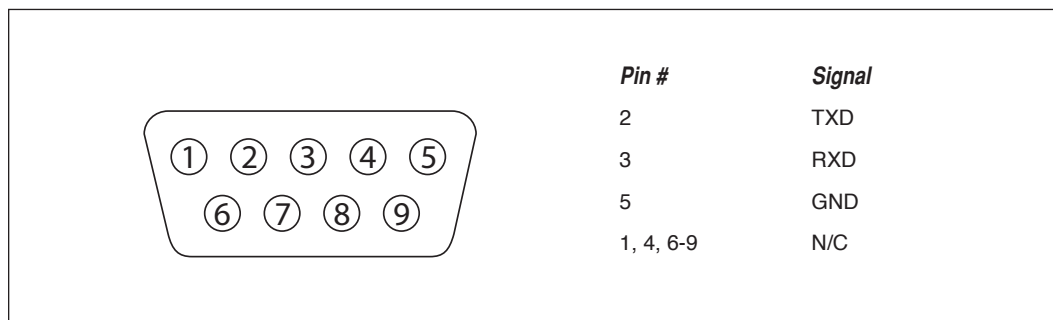

RS-232 9-Pin D-Sub Male

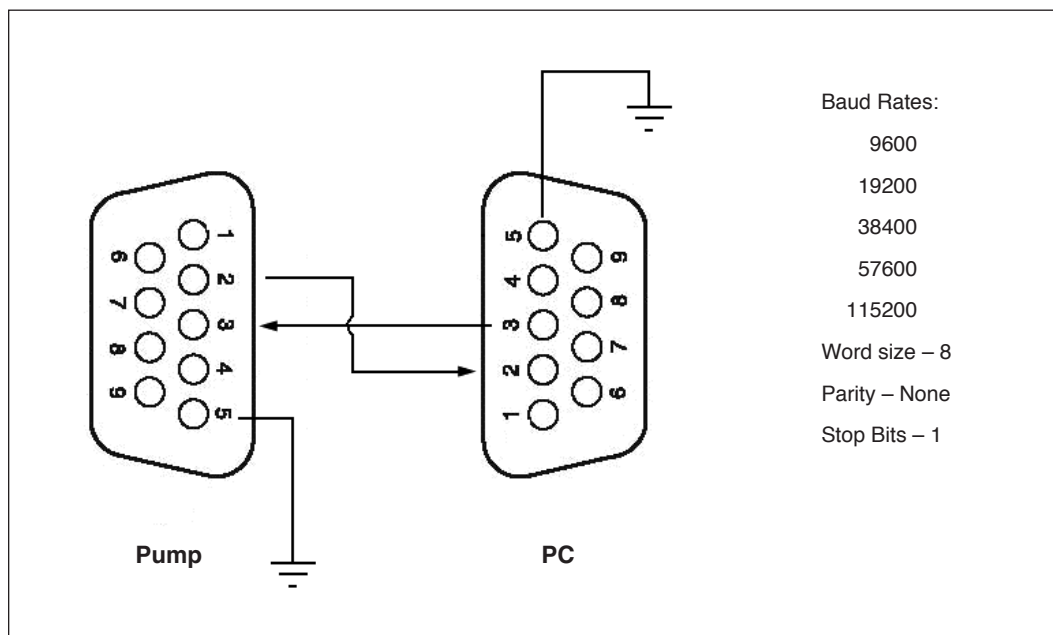

RS-232 Specifications

Legacy RJ-11 Option

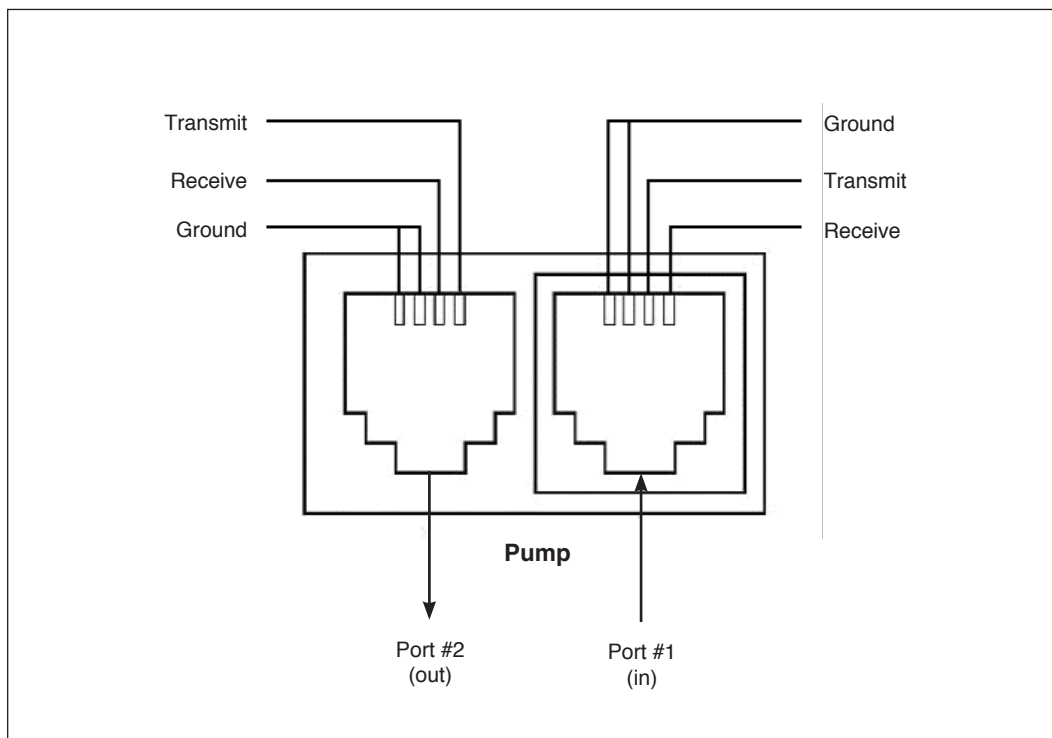

Pumps with Legacy RJ-11 Option.

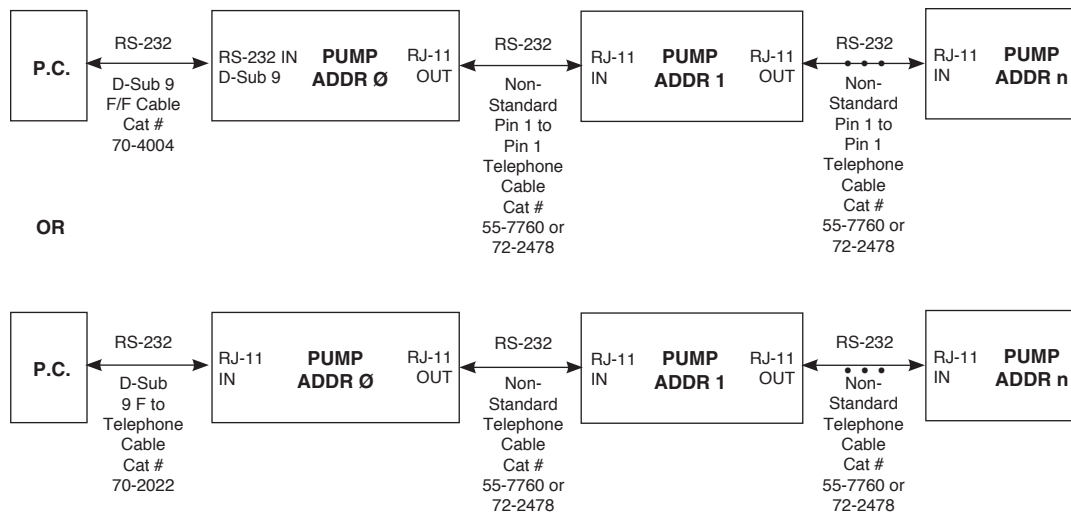

Daisy-Chaining with Legacy RJ-11 Option.

 **NOTE:** Pumps 1...n also have RJ-11 telephone jacks.

 **NOTE:** When daisy-chaining with RS-232, each pump must be self-powered. If a pump in the RS-232 daisy-chain is powered down, all pumps “down-stream” from it will lose communications.

PUMP-TO-PUMP CONNECTION RS-485



CAUTION: Do not connect to firewire ports on a PC. Damage may occur to pump and/or PC.

Mating Face	Pin #	RS-485 In Signal	RS-485 Out Signal	Notes
	1	PWR IN	PWR OUT (+30V)*	* Protected by resettable fuse
	2	GND	GND	
	3	RS-485 A	TIED TO PIN 4**	**100 Ω, ½ w to GND termination
	4	RS-485 B	TIED TO PIN 3**	
	5	TIED TO PIN 6**	RS-485 A	
	6	TIED TO PIN 5**	RS-485 B	

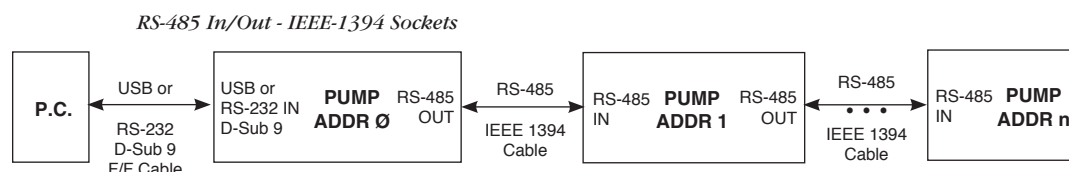

Daisy chaining via RS-485.

RS-485 Dasiy Chain Connection Options:

- If all pumps have software versions 2.0.0 or higher, 99 pumps in chain.
- If all pumps have software versions 1.3.7 or lower, 99 pumps in chain.
- If mix of pumps with software version 1.3.7 or lower and 2.0.0 or higher, maximum of 5 pumps in chain and 1 RS-485 adapter (catalog # 70-4025) required.



NOTE: When daisy-chaining with RS-485, at minimum, every fourth pump must be self powered (i.e., another stand-alone unit). This can be affected by Force Selection.



NOTE: When applying power to pumps in a daisy-chain, apply power to the last group and work backwards.



NOTE: When removing power, be sure to remember that power removed from a stand-alone unit will also cause power to be removed from all RS-485 powered units deriving power from it.



NOTE: Power may be removed from any group of pumps, except the first group, without affecting communications “down-stream”.



NOTE: If a chain of pumps with mixed software is desired, pumps with software versions 1.3.7 or lower can be returned to manufacturer for a hardware update.

Remote / Gradient Systems

Remote systems consist of a control box and remote unit attached via an RS-485 cable. Gradient systems consist of up to two pumps, satellites or stand alones, attached to a master pump via RS-485 cables.

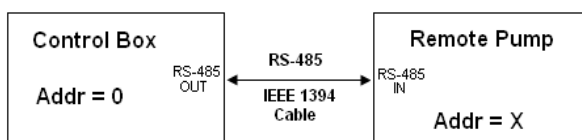

Remote System

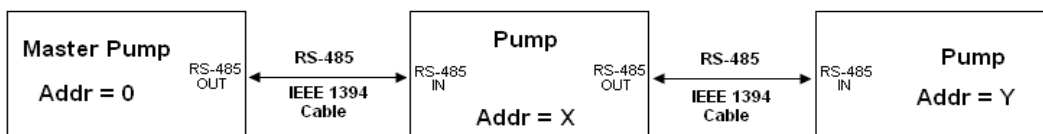

Gradient System

Connecting a Remote / Satellite Pump

When a remote pump is connected, using an RS-485 cable, to a control box or stand alone ULTRA a pump control button representing the remote unit will be displayed on the Method Main or Quick Start Main screen. In this button is a number that represents the remote's address. Gradient systems with two satellite units attached through an RS-485 cable will have two buttons displayed, one for each satellite.

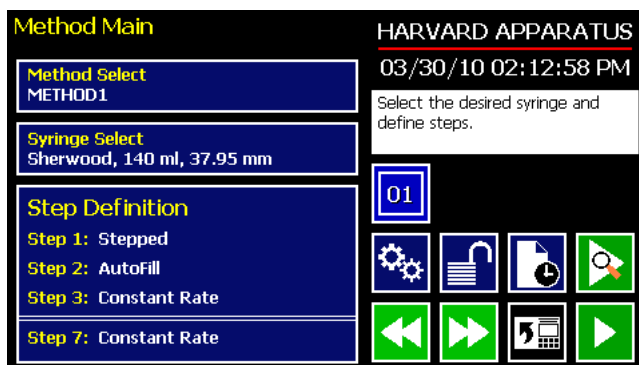

Method Main screen showing an active remote with an address of '01'

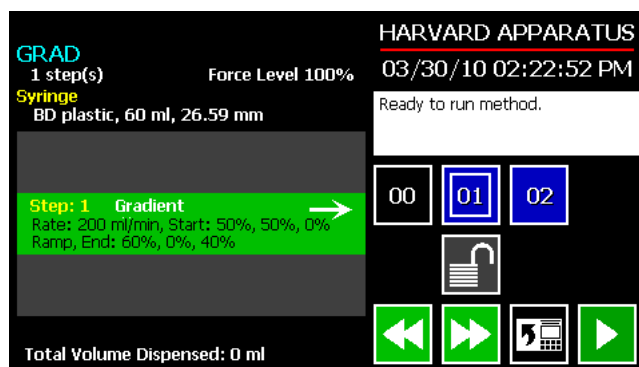

Method Main screen showing a Gradient system with 2 active satellites, addressed '01' and '02'. Pump '01' is being controlled by the master

The pump control button's background color indicates the status of the remote unit.

- Blue Background= Connected / Motor Stopped
- Red Background= Comm Error
- Yellow Background= Motor Stall
- Green Background= Motor Running

The user can select which pump to control by pressing the button with its corresponding address. The currently selected pump's button will contain an interior white box. When a satellite pump is being controlled the Fast Forward/Fast Reverse buttons on the master will move the satellite's pusher block.

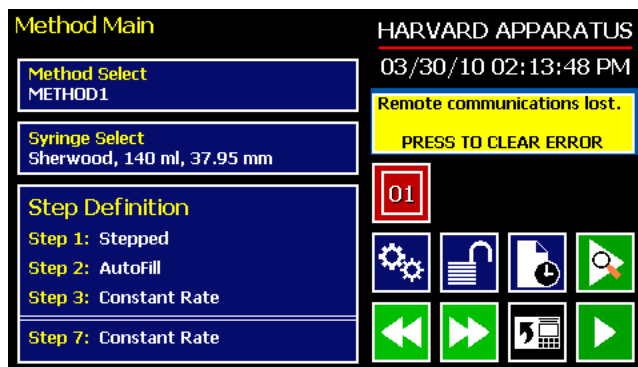

Method Main screen showing a comm error with the remote pump addressed '01'

Setting Addresses on Remote / Satellite Units

To change the address of a remote or satellite unit you need to communicate directly to the pump through a USB cable.

1. Connect the Remote / Satellite unit to a PC via a USB cable
2. Launch HyperTerminal
3. Set address using the appropriate Pump Chain Commands



NOTE: Remote units are set at a default address of '1'.

Setting the Address on the Control Box / Master Unit

The address of the control box or master unit must always be set to 0 (zero).

1. On the pump's touchscreen go to the Settings menu
2. Press the 'Address 0 / Remote X' button

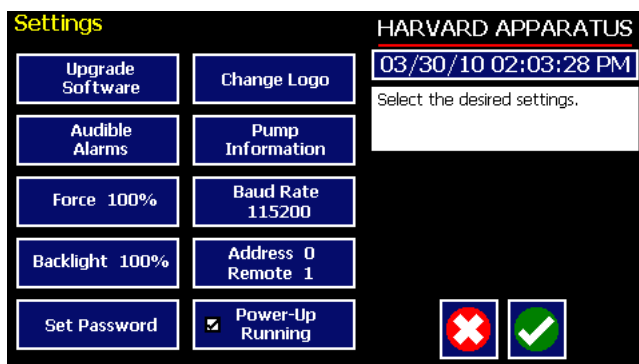

Settings screen showing the 'Address button'

3. Set the Pump Address to 0
4. Press 'Remote Address' and enter the address of the remote unit
5. Press 'Accept'

Set Pump Address

Pump Address 0

Remote address 1

HARVARD APPARATUS
03/30/10 02:06:42 PM

Enter a value between 0 and 99.

7 8 9
4 5 6
1 2 3
0

✖ ✔

*Set Pump Address
screen*



NOTE: For gradient systems the Remote Address must also be set to 0 in the Settings menu.

APPENDIX F: MAINTENANCE

Maintenance

PHD ULTRA™ series pumps require no special maintenance other than keeping them clean by avoiding accidental spills of pumped material. Refer to the chemical compatibility chart below for specific chemical resistance information.

The two guide rods and the lead screw should be sparingly lubricated periodically; every 100 hrs the pump will remind you. The guide rods and the lead screw should be lubricated with Super Lube Synthetic Grease provided with the pump.

To clean the exterior surfaces, use a lint-free cloth to remove loose dust. Use care to avoid scratching the clear display window. For more efficient cleaning, use a soft cloth dampened [not soaked] with water, an aqueous solution of 75% isopropyl alcohol, or a mild detergent.

Chemical Compatibility Chart				
Chemical	Concentration	Overlay Cover	Overlay Adhesive	Chassis
Acetonitrile	99.5%	A	A	A
Methyl alcohol	99.8%	A	-	A
Hydrochloric Acid	36.5%	A	A	A
Bleach	100%	A	A	A
Windex®	100%	A	A	A
Isopropyl Alcohol	99.5%	A	D	A
Dish Soap	–	A	A	A
Motor Oil	100%	A	A	A
Simple Green	100%	A	A	A
Gasoline	100%	A	D	C
Ethylene Glycol (Antifreeze)	100%	A	A	A
Mineral Oil	100%	A	A	A
Ammonia	27%	A	A	A
Magnalube	100%	A	A	A
Superlube	100%	A	A	A
Acetone	99.5%	A	D	D
Soda (Coca-Cola)®	100%	A	A	A
Sulfuric Acid	95%	D	D	A
Dimethyl Sulfoxide	99.9%	A	C	A
Sodium Hydroxide	50%	A	A	A
Nitric Acid	68%	D	D	C
Chloroform	100%	D	D	D

The chemical resistance data provided is for reference only. The data is based on the manufacturer's recommendations and is not a guarantee of chemical compatibility for your test conditions. Wipe any spills immediately.

A Satisfactory	D Severe Effects
B Fair, Minor Effects	– not tested
C Poor, Moderate Effects	

Fuse Replacement

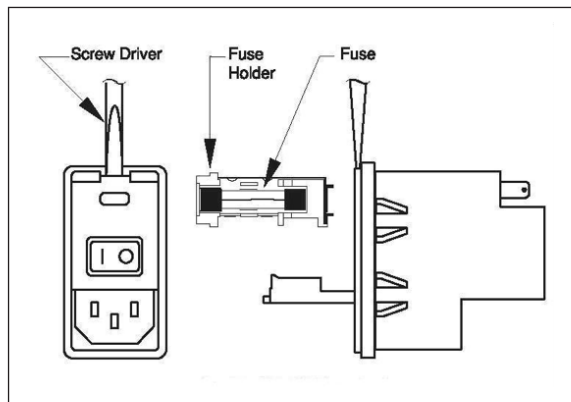

Key Information

1. Make sure the power cord is disconnected from the main supply before servicing the fuse.
2. Use only Type 3AG, 1/4" x 1 1/4, 1/2 amp, 250 volt; Type T (time delay) fuses (Harvard Apparatus Part No. 5146-037 or equivalent).

Turn off power and remove power cord from power module. Use a straight blade screwdriver to pry open the access door. Remove the fuse holder and then remove the fuses from this holder as shown in figure below. Replace fuses, and then replace the fuse holder.

Battery Replacement

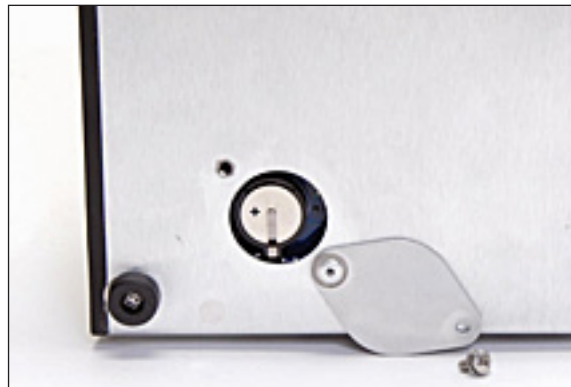

1. Remove screw and swing cover to the side.
2. Slide battery out from under clip.
3. Install Lithium Coin Battery: 3V, 16mm CR1620 (Harvard Part No. 5155-288 or equivalent) by sliding under clip with positive side facing out



CAUTION: Use only same type & rated battery. Observe polarity when installing.



NOTE: Does not apply to Remote/Satellite units.

Troubleshooting

Infusion Accuracy

To ensure infusion accuracy always use new syringe(s) and measure syringe bore diameter and enter actual dimensions in millimeters (mm) using the Custom Syringe entry option. Additionally, make sure that the guide rods and lead screw are properly lubricated.

RS-232 Difficulties

Verify that the baud rates, data framing parameters, data bits, parity, and stop bits on all devices are the same. Verify flow control (handshaking) is set to None. If an address is set to other than address Ø, make sure commands and queries are prefixed with the address. Make sure straight-through pinning is used for the cables; do not use null-modem cables.

Erase/Clear Disc:

There may be an instance where you want to delete all of your custom methods from the pump. There may also be instances where you may need to delete/clear the disc in order to power up the pump. To do so:

- Turn the pump on.
- When the start-up screen appears, press the 4 corners of the display in a clockwise order starting at the top left. After each corner is correctly pressed, it will turn dark gray.
- Press yes to confirm or wait 5 seconds to allow the pump to start normally without clearing the disc.
- There is a 5 second time limit for each press of the screen. If the time limit expires, the pump will start normally without clearing the disc.

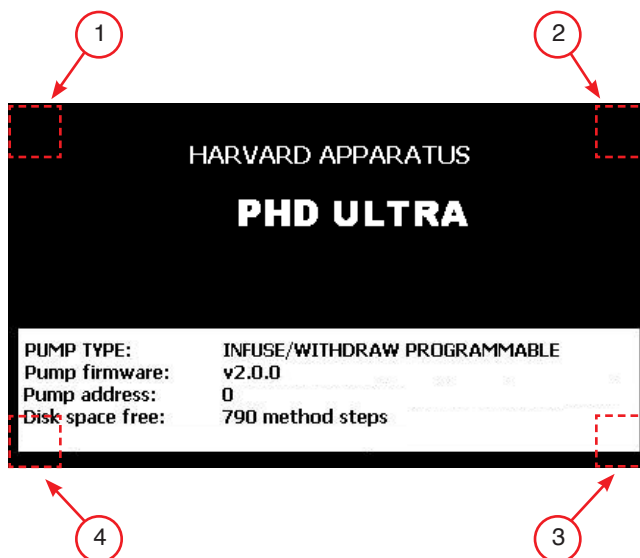

Press the 4 corners of the start-up screen display in a clockwise order to delete/clear the disc.



NOTE: It is recommended that you save your methods periodically by uploading them to a PC.

Unit won't power-up

Verify that the Power Source Switch on the rear of the pump is set to AC-IN if powering through linecord or RS-485 if powering in a chain.

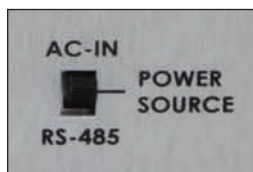

Upgrading EZ PRO™ Software

1. Upload the latest software version to your desktop (format is *filename.srec*).
2. Disconnect all I/O devices and then connect the pump to PC using a USB cable.
3. Press settings button then press Upgrade Software button twice to enter “Boot Loader Mode”..



NOTE: To exit bootloader mode without upgrading the software, power cycle the pump.



NOTE: Prior to upgrading, users will need to install the PHD ULTRA™ USB driver as well as the bootloader driver file (PHDUltra-Bootloader.inf). Reference “USB Virtual Comport Driver Installation”.

4. From the CD provided with the pump, open the ULTRA series Pump Updater Application.

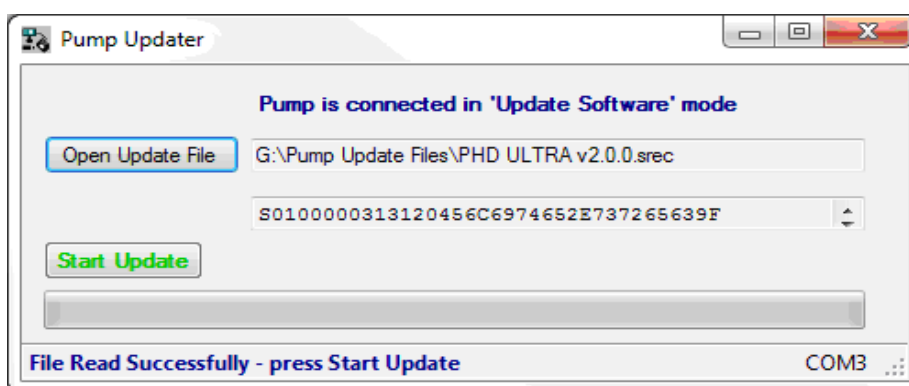

5. Click Open Update File and browse the file previously saved on your desktop and click Open.
6. Click Start Update

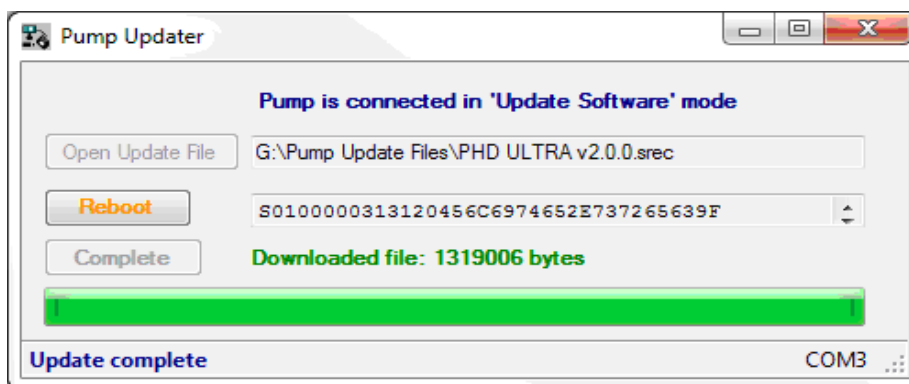

7. After the update is complete, press Reboot to power Cycle the pump.

PHD ULTRA™ Display Error Messages

Motor Stalled

This indicates that the pusher block travel has been impeded. This may be caused by the syringe plunger hitting bottom, a kink in the tubing (occlusion), syringe plunger binding or any situation requiring more force to the head of the syringe than the pump is capable of delivering. To restart the pump, remove the cause of stalling and/or increase the force setting, then press RUN. The pump will continue the interrupted procedure where it stopped.

Out of Range

A value was entered or encountered in a pump program that was beyond the pump's limits.

Power Failure Notification

If power to the pump is interrupted during operation, an alarm will sound to alert the user to the interruption. When power is restored, an onscreen message is displayed to indicate the interruption.

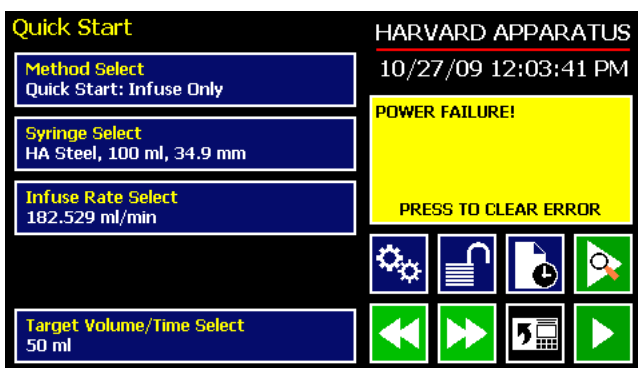

The PHD ULTRA™ Pump will notify you of a power failure with a message when power is restored.

Low Battery Indication

Time/Date area will turn red when battery is low. [See page 119 for instructions on changing the battery.]



The Time/Date area turns red when the battery is low.

APPENDIX G: SATELLITE BOXES

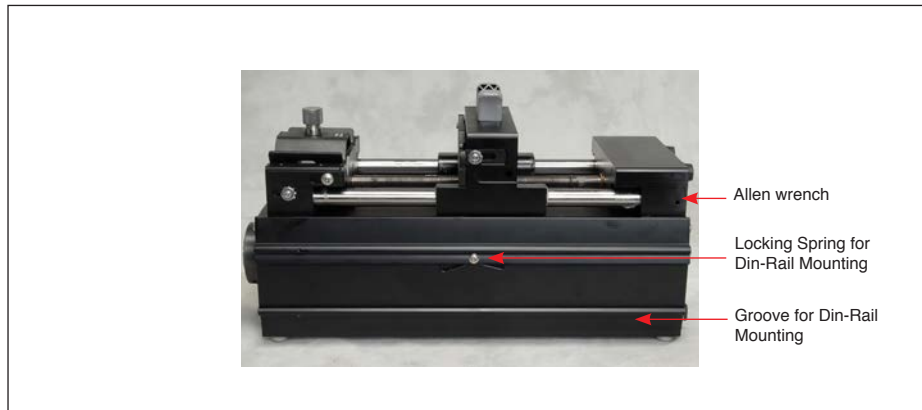

Back view of Satellite box.

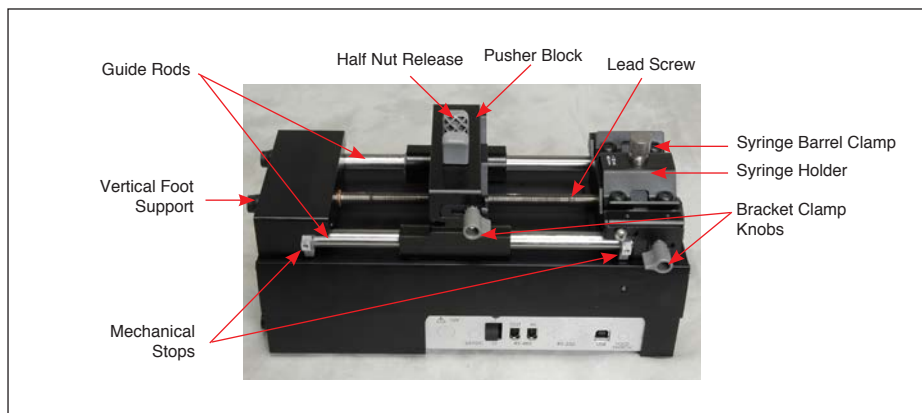

Front/Top view of Satellite box.

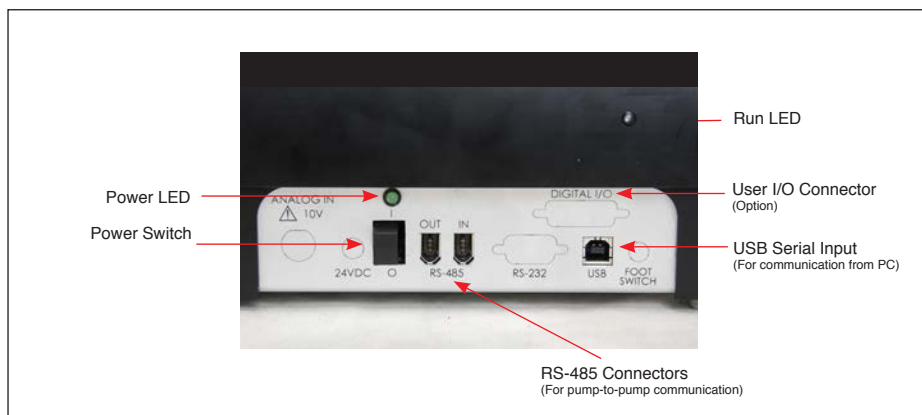

Close-up of Satellite box connections.

Master/Satellite Configurations

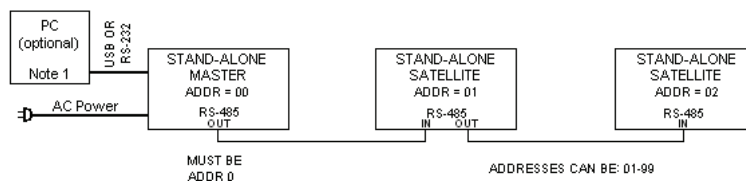

Master / Satellite operation using stand-alone (master) units as satellites

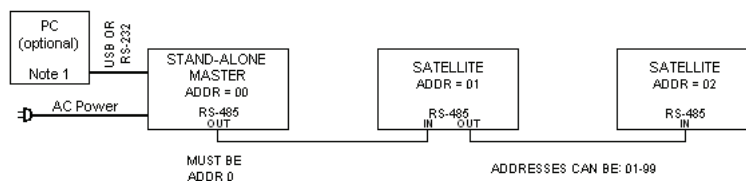

Master / Satellite operation using satellite / remote units

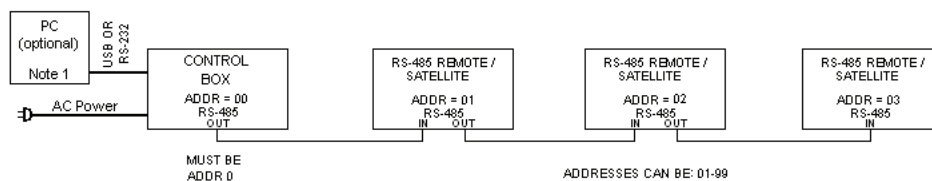

Gradients using remote system



NOTE: PC Control via HyperTerminal application. Limited command set (irun, wrun, stop, stp)

When using stand-alone units as satellites do not connect the line cord and leave the power switch in the OFF ('0') position. Connect units using an RS-485 cable (OUT to IN). Power up Master Unit - Master and Satellites will all power up and Satellites should indicate "Satellite XX" on their displays, where "XX" represents pump address. When using remote units as satellites power switches all operate as indicated - turn ON each pump on the RS-485 network.



NOTE: If it is desired to power a Stand-Alone unit as a Satellite by using the line cord and internal power supply, connect line cord and set power switch to ON ('1') position.



NOTE: If a satellite powers up but displays the Main GUI screen instead of "Satellite XX" verify that the address of the Satellite is not set to '00'.



NOTE: Each satellite must have a unique address.

Setting Addresses on Satellite / Remote Units

1. Connect Satellite / Remote unit to PC via a USB cable
2. Launch HyperTerminal
3. Set address using the appropriate Pump Chain Commands

Setting Forces on Satellite / Remote Units

1. Connect Satellite / Remote unit to PC via a USB cable
2. Launch HyperTerminal
3. Set force to desired level, in percent, using the appropriate Pump Chain Commands



NOTE: For software versions prior to 1.3.0 the Force level needs to be set from a PC via a USB cable. With software versions 1.3.0 and newer the Force Level will be sent down to the remote/satellite units directly from the master.

Optional PC-to-Pump Configurations

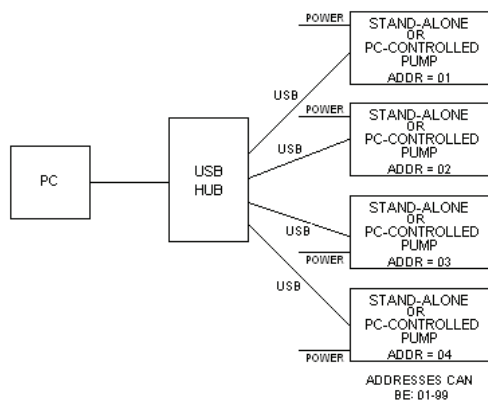

PC Control configuration option

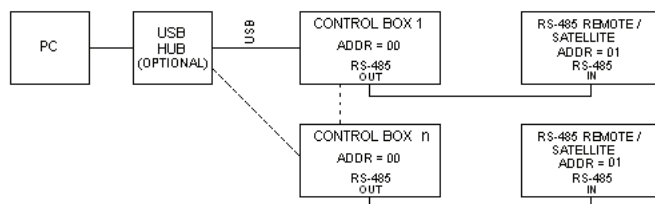

PC Control configuration option



NOTE: Control Box must be set at address '0'.



NOTE: Unique comports must be selected for each remote system.

APPENDIX H: REMOTE STAND

The Remote Stand accessory allows the user to maximize bench space by mounting two satellite / remote or PC controlled units with a Master Stand Alone pump at the stand's base.

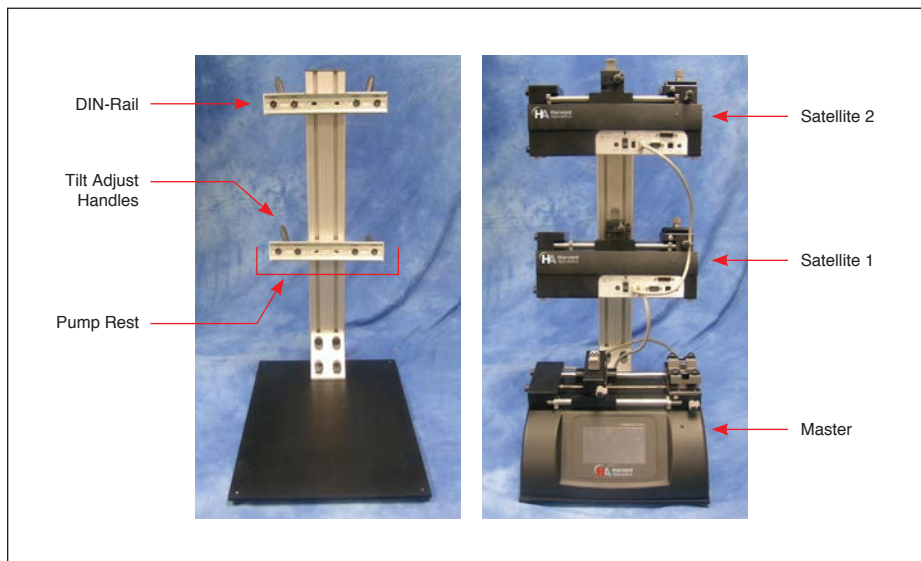

Adjusting DIN-Rail Height

1. Loosen both Height Adjust Knobs located on the sides of the Pump Rest.
2. Slide the Pump Rest to your desired height.
3. Tighten both Height Adjust Knobs securely.



NOTE: If adjusting the height with a pump attached, loosen one Height Adjust Knob, then use one hand to support the pump while loosening the second Height Adjust Knob.



NOTE: Slot covers, provided as stops to prevent the Pump Rests from colliding, are located in the slots on the side of the stand. The stops can be trimmed to provide more traveling room for the Pump Rests. To trim: pop out the cover using a screw driver, cut to desired length with scissors, then snap back into place.

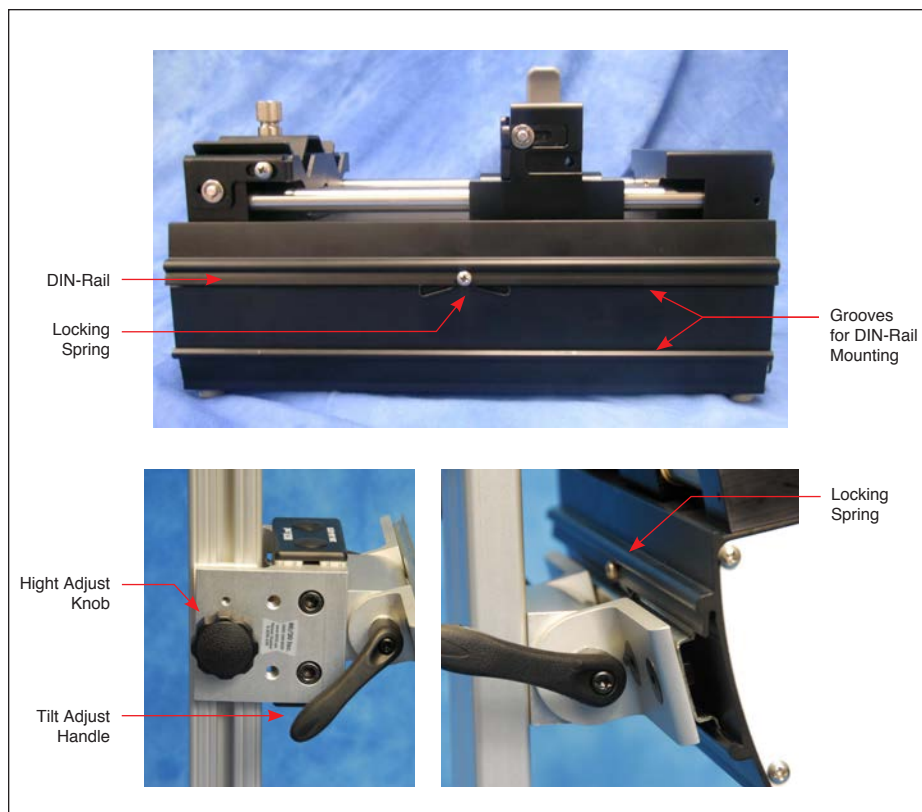

Adjusting DIN-Rail Tilt

1. Loosen both Tilt Adjust handles by turning clockwise. To increase the handles range of motion, pull the handle out and twist counter-clockwise then allow the handle to click back into place.
2. Once both handles have been loosened, tilt the DIN-Rail to your desired angle and tighten into place using the Tilt-Adjust Handles.



NOTE: Ensure that the DIN-Rail is tightened securely using the Tilt-Adjust Handles to prevent any movement when the pump is attached.

Mounting a Pump

1. The rear side of a Satellite / Remote pump has a Groove with a Locking Spring for DIN-Rail mounting. Position the pump's top groove and locking spring over the top edge of the DIN-Rail.
2. Push the top of the pump down against the spring while pushing the bottom of the pump back until the bottom groove locks under the DIN-Rail.

Dismounting a Pump

1. Holding both sides of the pump, push down on the top of the pump to depress the Locking Spring.
2. Tilt the bottom of the pump out to release the bottom Groove from the DIN-Rail.
3. Lift the pump off of the DIN-Rail.

APPENDIX I: ORDERING INFORMATION

Standard Version

<i>Description</i>	<i>Stand Alone System</i>	<i>Remote System</i>	<i>Satellite</i>	<i>Syringe Pump Module</i>
PHD ULTRA™ Infuse Only	70-3005	70-3305	N/A	N/A
PHD ULTRA™ Infuse/Withdraw	70-3006	70-3306	70-3406	70-3506
PHD ULTRA™ Infuse/Withdraw Programmable	70-3007	70-3307	N/A	N/A

Push/Pull Versions

<i>Description</i>	<i>Stand Alone System</i>	<i>Remote System</i>	<i>Satellite</i>	<i>Syringe Pump Module</i>
PHD ULTRA™ w/ Push/Pull Mechanism	70-3008	70-3308	70-3408	70-3508
PHD ULTRA™ Programmable w/ Push/Pull Mechanism	70-3009	70-3309	N/A	N/A

Rack Options

<i>Catalog #</i>	<i>Description</i>
70-3020	6/10 Multi-Rack. Holds up to 10 syringes from 0.5 μ l to 20 ml and up to 6 syringes from 30 ml to 60 ml.
70-3021	4x140 Multi-Rack. Holds four 60 ml or 140 ml plastic syringes only.
70-3022	Microliter Multi-Rack. Independently holds 4 syringes from 0.5 μ l to 10 ml.
70-3023	Anti-Siphon Kit

Options

<i>Catalog #</i>	<i>Description</i>
70-3030	PHD ULTRA™ RS-232 RJ-11 Connectors Option†
70-3041	PHD ULTRA™ Analog Control Input Option (0-10v)** †
70-3034	PHD ULTRA™ Internal Fan Option
70-3035	PHD ULTRA™ Digital I/O Option

* Only available with I/W and Programmable Models

** Only available with Programmable Models

† Not available on satellite boxes

Accessories

Catalog #	Description
70-4000	RS-485 Cable for Pump-to-Pump Communication, 0.5 m
70-4021	RS-485 Cable for Pump-to-Pump Communication, 1 m
70-4001	RS-485 Cable for Pump-to-Pump Communication, 2 m
70-4020	RS-485 Cable for Pump-to-Pump Communication, 30 ft
70-4002	USB Cable for PC-to-Pump Communication, 2 m
70-4003	USB Cable for PC-to-Pump Communication, 5 m
70-4004	RS-232 Cable for PC-to-Pump Communication, 9 pin D-sub, 2 m
55-7760	Cable Assy, Daisy-chain, Legacy RS-232 RJ-11, 2 ft
72-2478	Cable Assy, Daisy-chain, Legacy RS-232 RJ-11, 7 ft
5113-001	Line Cord, US (115 v)
70-3039	Cable for Analog Control Option
70-4005	Adapter, PHD Digital I/O
70-4006	Adapter, D-sub 15 to Term. Blk
70-2215	Footswitch (w/ Phono Plug)
55-7010	Auto Fill Valve Box, Low Pressure
55-7012	Auto Fill Valve Box, Medium Pressure
55-7008	Auto Fill Valve Box, High Pressure
55-7009	Continuous Delivery Valve Box, Low Pressure
55-7013	Continuous Delivery Valve Box, Medium Pressure
55-7007	Continuous Delivery Valve Box, High Pressure
2401-086	Adapter for 25ml, 50ml, 100ml Hamilton GasTight™ syringes
5012-005	Hex Key, 3/32
70-4013	Lubricant, SuperLube, 1cc
70-4019	Stand (holds 1 master pump plus 2 satellites)
70-4025	RS-485 Adapter (See Appendix E: External Connections)

Upgrades

Catalog #	Description
70-4010	Upgrade Infuse Only to I/W *†
70-4011	Upgrade Infuse Only to Programmable *†
70-4012	Upgrade I/W to Programmable *†

*Requires Return to Factory

† Not available on satellite boxes

For additional items such as Syringe Heaters, Spill Sensors, Temperature Controllers, Nano-Fluidic Accessories, and much more please visit our website www.harvardapparatus.com or call (800) 272-2775.

Declaration of Conformity

Manufacturer: **Harvard Apparatus, Inc.**
84 October Hill Road
Holliston, Massachusetts 01746-1388, U.S.A.
Phone: (508) 893-8999

We herewith declare that the following product:

Product Name: **PHD ULTRA™ Syringe Pump Series**
Model No.: **PHD ULTRA™ - Catalog # 70-3xxx**

To which this declaration relates, is in conformity with the applicable EC Directives, harmonized standards, and other normative requirements:

Application of
Council Directive(s): **2006/95/EC** **Low Voltage Directive**
2004/108/EC **Electromagnetic Compatibility Directive**
2011/65/EU **RoHS Directive**

Standard(s) to which
conformity is declared:

Safety: **EN 61010-1:2012 (3rd Edition)**
Emmissions/Immunity: **IEC 61326-1:2005, Ed.1**
IEC 61000-4-2
IEC 61000-4-3:2002
IEC 61000-4-4:2004
IEC 61000-4-5:2001
IEC 61000-4-6:2003
IEC 61000-4-8:1993
IEC 61000-4-11:2004
IEC 61000-3-2:2000
IEC 61000-3-3:2002
CISPR11:2003+A1:2004, Group 1, Class A

EMC and Safety compliance were evaluated by Intertek/ETL Semko

Reference test report
file numbers: **3177745 BOX-001, -003, -004, -005A, -006A, -007B,**
3195998 BOX-005a
100602834 BOX-004, -004a

I, the undersigned, hereby declare that the equipment specified above conforms to the above Directive(s) and Standard(s).

Place: **United States of America**
Date: **April 02, 2012**



(Signature)

Beth Bauman
(Full Name)

VP Engineering / Operations
(Position)

