

# Operating Manual

- BD (E3.1) | Incubators Avantgarde.Line with natural convection  
 BF (E3.1) | Incubators Avantgarde.Line with forced convection  
 ED (E3.1) | Drying and heating ovens Avantgarde.Line with natural convection  
 FD (E3.1) | Drying and heating ovens Avantgarde.Line with forced convection  
 FED (E3.1) | Drying and heating ovens Avantgarde.Line with forced convection and enhanced timer functions

with microprocessor temperature controller

Model	Model version	Art. No.	Model	Model version	Art. No.
BD 56	BD056-230V	9010/ 9110-0323	ED 260	ED260-230V	9010/ 9110-0339
	BD056UL-120V	9010/ 9110-0324		ED260UL-240V	9010/ 9110-0340
BD 115	BD115-230V	9010/ 9110-0325	ED 720	ED720-400V	9010/ 9110-0341
	BD115UL-120V	9010/ 9110-0326	FD 56	FD056-230V	9010/ 9110-0303
BD 260	BD260-230V	9010/ 9110-0329		FD056UL-120V	9010/ 9110-0304
	BD260UL-120V	9010/ 9110-0330	FD 115	FD115-230V	9010/ 9110-0305
BD 720	BD720-230V	9010/ 9110-0331		FD115UL-120V	9010/ 9110-0306
	BD720UL-240V	9010/ 9110-0332	FD 260	FD260-230V	9010/ 9110-0309
BF 56	BF056-230V	9010/ 9110-0313		FD260UL-240V	9010/ 9110-0310
	BF056UL-120V	9010/ 9110-0314	FD 720	FD720-400V	9010/ 9110-0311
BF 115	BF115-230V	9010/ 9110-0315	FED 56	FED056-230V	9010/ 9110-0295
	BF115UL-120V	9010/ 9110-0316		FED056UL-120V	9010/ 9110-0296
BF 260	BF260-230V	9010/ 9110-0319	FED 115	FED115-230V	9010/ 9110-0293
	BF260UL-120V	9010/ 9110-0320		FED115UL-120V	9010/ 9110-0294
BF 720	BF720-230V	9010/ 9110-0321	FED 260	FED260-230V	9010/ 9110-0299
	BF720UL-240V	9010/ 9110-0322		FED260UL-240V	9010/ 9110-0300
ED 56	ED056-230V	9010/ 9110-0333	FED 720	FED720-400V	9010/ 9110-0301
	ED056UL-120V	9010/ 9110-0334		FED720UL-208V	9010/ 9110-0302
ED 115	ED115-230V	9010/ 9110-0335			
	ED115UL-120V	9010/ 9110-0336			

## BINDER GmbH

- ▶ Address: Post office box 102, 78502 Tuttlingen, Germany ▶ Phone: +49 7462 2005 0
- ▶ Fax: +49 7462 2005 100 ▶ Internet: <http://www.binder-world.com>
- ▶ E-mail: [info@binder-world.com](mailto:info@binder-world.com) ▶ Service Hotline: +49 7462 2005 555
- ▶ Service Fax: +49 7462 2005 93 555 ▶ Service E-Mail: [service@binder-world.com](mailto:service@binder-world.com)
- ▶ Service Hotline USA: +1 866 885 9794 or +1 631 224 4340 x3
- ▶ Service Hotline Asia Pacific: +852 390 705 04 or +852 390 705 03
- ▶ Service Hotline Russia and CIS: +7 495 988 15 16

## Content

<b>1.</b>	<b>SAFETY</b> .....	<b>5</b>
1.1	Legal considerations .....	5
1.2	Structure of the safety instructions.....	5
1.2.1	Signal word panel.....	5
1.2.2	Safety alert symbol.....	6
1.2.3	Pictograms.....	6
1.2.4	Word message panel structure .....	7
1.3	Localization / position of safety labels on the chamber .....	7
1.4	Type plate.....	8
1.5	General safety instructions on installing and operating the chambers .....	9
1.6	Intended use .....	11
<b>2.</b>	<b>CHAMBER DESCRIPTION</b> .....	<b>12</b>
2.1	Chamber overview .....	12
2.2	Triangular instrument panel .....	13
2.3	Main power switch ED, FD, FED 720 .....	14
<b>3.</b>	<b>COMPLETENESS OF DELIVERY, TRANSPORTATION, STORAGE, AND INSTALLATION</b> .....	<b>14</b>
3.1	Unpacking, and checking equipment and completeness of delivery .....	14
3.2	Guidelines for safe lifting and transportation.....	15
3.3	Storage.....	15
3.4	Location of installation and ambient conditions .....	15
<b>4.</b>	<b>INSTALLATION</b> .....	<b>17</b>
4.1	Mounting the tilt protection holders (chambers with window) .....	17
4.2	Electrical connection .....	18
4.3	Connection to an exhaust/ventilation system (optional) .....	19
<b>5.</b>	<b>START UP</b> .....	<b>20</b>
5.1	Behavior when opening the door .....	20
<b>6.</b>	<b>OVERVIEW AND GENERAL SETTINGS ON THE R4 CONTROLLER</b> .....	<b>21</b>
6.1	Controller overview .....	21
6.2	Normal display .....	21
6.3	Setting the menu language .....	22
6.4	Setting date and time .....	23
6.5	Selecting the temperature unit .....	25
6.6	Set-point entry for temperature and fan speed .....	26
6.6.1	Set-point entry for temperature in two-door chambers (ED, FD, FED 720) .....	27
6.7	Adjusting the air flap position .....	28
6.8	Changing the passwords for user level and general controller functions .....	29
<b>7.</b>	<b>OVERTEMPERATURE PROTECTION</b> .....	<b>31</b>
7.1	Overtemperature protective device (class 1) .....	31
7.2	Safety controller .....	32
7.3	Setting the safety controller set-point.....	33
7.4	Alarm message and proceeding in case of an alarm.....	34
7.5	Function check .....	34
7.6	Disconnectable audible over-temperature alarm (option).....	35
<b>8.</b>	<b>TIMER FUNCTIONS</b> .....	<b>36</b>
8.1	Selecting the timer function.....	36
8.2	Timer function "Delayed Off" .....	37
8.2.1	Entry and activation of the timer run-time and fan setting.....	37
8.2.2	Turning off the timer function or changing the settings .....	39

8.3	Timer function “Temperature dependent Delayed Off” (BF, FED) .....	41
8.3.1	Entry and activation of the timer run-time, fan setting and set-point entry .....	41
8.3.2	Turning off the timer function or changing the settings .....	43
8.4	Timer function “Delayed On” (BF, FED) .....	44
8.4.1	Entry and activation of the timer run-time and fan setting .....	44
8.4.2	Changing the settings .....	46
8.5	Temperature programming example (BF, FED) .....	46
<b>9.</b>	<b>RAMP FUNCTION .....</b>	<b>47</b>
9.1	General information .....	47
9.2	Setting and displaying the ramp function .....	48
9.3	Displaying the effective ramp set-point and changing the target ramp set-point .....	49
9.4	Turning off the ramp function .....	50
<b>10.</b>	<b>DATA RECORDING VIA USB INTERFACE .....</b>	<b>51</b>
10.1	Starting data recording .....	51
10.2	Terminating data recording .....	52
<b>11.</b>	<b>NETWORK CONFIGURATION FOR CHAMBERS WITH ETHERNET INTERFACE .....</b>	<b>53</b>
<b>12.</b>	<b>OPTIONS .....</b>	<b>56</b>
12.1	Communication software APT-COM™ 3 DataControlSystem (option) .....	56
12.2	Data logger kits (option) .....	56
12.3	Object temperature display with additional Pt100 temperature sensor (option) .....	56
12.4	Analog output for temperature (option) .....	57
12.5	Water protected disconnectable internal socket (option BD, BF) .....	57
12.6	HEPA fresh air filter (option for FD, FED) .....	58
12.7	Mostly gas-tight version (option for BF, FD, FED) .....	58
12.8	Inert gas connection with mostly gas-tight version (option for BF, FD, FED) .....	58
<b>13.</b>	<b>MAINTENANCE, CLEANING, AND SERVICE .....</b>	<b>60</b>
13.1	Maintenance intervals, service .....	60
13.2	Cleaning and decontamination .....	61
13.2.1	Cleaning .....	61
13.2.2	Decontamination .....	62
13.3	Sending the chamber back to BINDER GmbH .....	63
<b>14.</b>	<b>DISPOSAL .....</b>	<b>64</b>
14.1	Disposal of the transport packing .....	64
14.2	Decommissioning .....	64
14.3	Disposal of the chamber in the Federal Republic of Germany .....	64
14.4	Disposal of the chamber in the member states of the EU except for the Federal Republic of Germany .....	65
14.5	Disposal of the chamber in non-member states of the EU .....	66
<b>15.</b>	<b>TROUBLESHOOTING .....</b>	<b>67</b>
<b>16.</b>	<b>TECHNICAL DESCRIPTION .....</b>	<b>68</b>
16.1	Factory calibration and adjustment .....	68
16.2	Definition of usable volume .....	68
16.3	Over current protection .....	68
16.4	BD technical data .....	69
16.5	BF technical data .....	70
16.6	ED technical data .....	72
16.7	FD technical data .....	74
16.8	FED technical data .....	75
16.9	Equipment and options (extract) .....	77
16.10	Accessories and spare parts (extract) .....	78

---

16.11	Dimensions size 56 .....	80
16.12	Dimensions size 115 .....	82
16.13	Dimensions size 260 .....	84
16.14	Dimensions size 720 .....	86
<b>17.</b>	<b>CERTIFICATES AND DECLARATIONS OF CONFORMITY .....</b>	<b>89</b>
17.1	EU Declaration of Conformity for BD .....	89
17.2	EU Declaration of Conformity for BF .....	91
17.3	EU Declaration of Conformity for ED .....	93
17.4	EU Declaration of Conformity for FD .....	95
17.5	EU Declaration of Conformity for FED .....	97
<b>18.</b>	<b>PRODUCT REGISTRATION .....</b>	<b>99</b>
<b>19.</b>	<b>CONTAMINATION CLEARANCE CERTIFICATE .....</b>	<b>100</b>
19.1	For chambers located outside the USA and Canada .....	100
19.2	For chambers located in the USA and Canada .....	103





**Dear customer,**

For the correct operation of the chambers, it is important that you read this operating manual completely and carefully and observe all instructions as indicated. Failure to read, understand and follow the instructions may result in personal injury. It can also lead to damage to the chamber and/or poor equipment performance

## 1. Safety

This operating manual is part of the components of delivery. Always keep it handy for reference. The device should only be operated by laboratory personnel especially trained for this purpose and familiar with all precautionary measures required for working in a laboratory. Observe the national regulations on minimum age of laboratory personnel To avoid injuries and damage observe the safety instructions of the operating manual.

	 <b>WARNING</b>
	<p><b>Failure to observe the safety instructions. Serious injuries and chamber damage.</b></p> <ul style="list-style-type: none"> <li>➤ Observe the safety instructions in this operating manual</li> <li>➤ Carefully read the complete operating instructions of the chambers.</li> </ul>

### 1.1 Legal considerations

This operating manual is for informational purposes only. It contains information for installing, start-up, operation and maintenance of the product. Note: the contents and the product described are subject to change without notice.

Understanding and observing the instructions in this operating manual are prerequisites for hazard-free use and safety during operation and maintenance. In no event shall BINDER be held liable for any damages, direct or incidental arising out of or related to the use of this manual.

This operating manual cannot cover all conceivable applications. If you would like additional information, or if special problems arise that are not sufficiently addressed in this manual, please ask your dealer or contact us directly by phone at the number located on page one of this manual

Furthermore, we emphasize that the contents of this operating manual are not part of an earlier or existing agreement, description, or legal relationship, nor do they modify such a relationship. All obligations on the part of BINDER derive from the respective purchase contract, which also contains the entire and exclusively valid statement of warranty administration. The statements in this manual neither augment nor restrict the contractual warranty provisions.

### 1.2 Structure of the safety instructions

In this operating manual, the following safety definitions and symbols indicate dangerous situations following the harmonization of ISO 3864-2 and ANSI Z535.6.

#### 1.2.1 Signal word panel

Depending on the probability of serious consequences, potential dangers are identified with a signal word, the corresponding safety color, and if appropriate, the safety alert symbol.

 <b>DANGER</b>
<p>Indicates an imminently hazardous situation that, if not avoided, will result in death or serious (irreversible) injury.</p>

**WARNING**

Indicates a potentially hazardous situation which, if not avoided, could result in death or serious (irreversible) injury

**CAUTION**

Indicates a potentially hazardous situation which, if not avoided, may result in moderate or minor (reversible) injury

**CAUTION**

Indicates a potentially hazardous situation which, if not avoided, may result in damage to the product and/or its functions or of a property in its proximity.

### 1.2.2 Safety alert symbol





Use of the safety alert symbol indicates a **risk of injury**.

Observe all measures that are marked with the safety alert symbol in order to avoid death or injury.

### 1.2.3 Pictograms

Warning signs			
Electrical hazard	Hot surface	Explosive atmosphere	Stability hazard
Lifting hazard	Risk of corrosion and / or chemical burns	Suffocation hazard	Harmful substances
Biohazard	Pollution Hazard		
Mandatory action signs			
Mandatory regulation	Read operating instructions	Disconnect the power plug	Lift with several persons
Lift with mechanical assistance	Environment protection	Wear protective gloves	Wear safety goggles

Prohibition signs			
 Do NOT touch	 Do NOT spray with water		

	<b>Information</b> to be observed in order to ensure optimum function of the product.
---	---



### 1.2.4 Word message panel structure

<p><b>Type / cause of hazard.</b></p> <p><b>Possible consequences.</b></p> <p>∅ Instruction how to avoid the hazard: prohibition.</p> <p>➤ Instruction how to avoid the hazard: mandatory action.</p>
---

Observe all other notes and information not necessarily emphasized in the same way, in order to avoid disruptions that could result in direct or indirect injury or property damage.

### 1.3 Localization / position of safety labels on the chamber

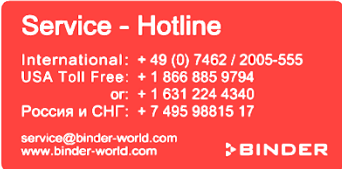
The following labels are located on the chamber:

Pictograms (Warning signs)	Service label
 <p>Hot surface</p> <ul style="list-style-type: none"> <li>• ED, FD, FED: outer chamber door</li> <li>• BD, BF: on the glass door handle</li> <li>• On chamber rear next to the exhaust duct</li> </ul>	
 <p>Read operating manual</p> <ul style="list-style-type: none"> <li>• UL chamber: outer chamber door</li> <li>• BD, BF with optional interior socket: below the interior socket</li> </ul>	

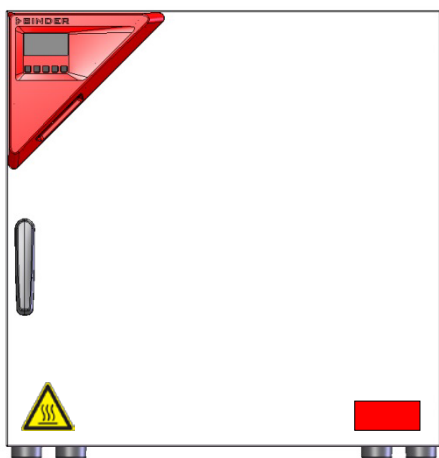

ED, FD, FED

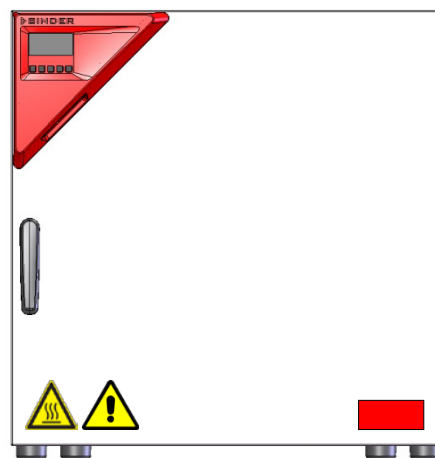

ED-UL, FD-UL, FED-UL

Figure 1: Position of labels on the chamber front (example: ED, FD, FED size 56)



Keep safety labels complete and legible.

Replace safety labels that are no longer legible. Contact BINDER Service for these replacements.

## 1.4 Type plate

The type plate is located on the left-hand side of the chamber, bottom right-hand.

Nominal temp.	300 °C 572 °F	1,30 kW / 5,7 A 230 V / 50 Hz			
IP protection	20	230 V / 60 Hz			
Safety device	DIN 12880	1 N ~			
Class	2.0				
Art. No.	9010-0305				
Project No.					
Built	2017	Drying and heating oven			
			BINDER GmbH Im Mittleren Ösch 5 78532 Tuttlingen / Germany www.binder-world.com	<b>FED 115</b> <b>E3.1</b>	<b>Serial No. 0000000000000</b> Made in Germany

Figure 2: Type plate (example FED 115-230V regular chamber)









Nominal temp.	100 °C 212 °F	0,35 kW / 1,6 A 230 V / 50 Hz			
IP protection	20	230 V / 60 Hz			
Safety device	DIN 12880	1 N ~			
Class	3.1				
Art. No.	9110-0325				
Project No.					
Built	2017	Incubator			
			BINDER GmbH Im Mittleren Ösch 5 78532 Tuttlingen / Germany www.binder-world.com	<b>BD 115</b> <b>E3.1</b>	With option internal socket: Nominal power: 0,85 kW  <b>Serial No. 0000000000000</b> Made in Germany

Figure 3: Type plate (example BD 115-230V optional chamber)

Indications of the type plate (example)		Information
BINDER		Manufacturer: BINDER GmbH
BD 115		Model designation
Incubator		Chamber name: Incubator
Drying and heating oven		Chamber name: Drying and heating oven
Serial No.	000000000000	Serial No of the chamber
Built	2017	Year of construction
Nominal temperature	100 °C 212 °F	Nominal temperature
IP protection	20	IP type of protection acc. to EN 60529
Temp. safety device	DIN 12880	Temperature safety device acc. to standard DIN 12880
Class	3.1	Class of temperature safety device
Art. No.	9110-0305	Art. no. of the chamber
Project No.	---	Optional: Special application acc. to project no.
1,30 kW		Nominal power
5,7 A		Nominal current
230 V / 50 Hz		Nominal voltage ± 10% at the indicated power frequency
230 V / 60 Hz		
1 N ~		Current type
With option internal socket: Nominal power: 0,85 kW		With option internal socket: increased total nominal power

Symbol on the type plate	Information
	CE conformity marking
	Electrical and electronic equipment manufactured / placed on the market in the EU after 13 August 2005 and to be disposed of in a separate collection according to Directive 2012/19/EU on waste electrical and electronic equipment (WEEE).
	The chamber is certified according to Customs Union Technical Regulation (CU TR) for the Eurasian Economic Union (Russia, Belarus, Armenia, Kazakhstan Kyrgyzstan).
	GS mark of conformity of the "VDE Prüf- und Zertifizierungsinstitut" (Testing and Certification Institute of the Association for Electrical, Electronic and Information Technologies)
 (UL chambers only)	The chamber is certified by Underwriters Laboratories Inc. <sup>®</sup> according to the following standards: UL 61010-1, 3 <sup>rd</sup> Edition, 2012-05, rev. 2015-07 CAN/CSA-C22.2 No. 61010-1, 3 <sup>rd</sup> Edition, 2012-05, rev. 2015-07 IEC 61010-2-10 :2014, 3 <sup>rd</sup> Edition

## 1.5 General safety instructions on installing and operating the chambers



With regard to operating the chambers and to the installation location, please observe the DGUV guidelines 213-850 on safe working in laboratories (formerly BGI/GUV-I 850-0, BGR/GUV-R 120 or ZH 1/119, issued by the employers' liability insurance association) (for Germany).

BINDER GmbH is only responsible for the safety features of the chamber provided skilled electricians or qualified personnel authorized by BINDER perform all maintenance and repair, and if components relating to chamber safety are replaced in the event of failure with original spare parts.



To operate the chamber, use only original BINDER accessories or accessories from third-party suppliers authorized by BINDER. The user is responsible for any risk caused by using unauthorized accessories.

	<b>CAUTION</b>
	<p><b>Danger of overheating.</b> <b>Damage to the chamber.</b></p> <ul style="list-style-type: none"> <li>⊘ Do NOT install the chamber in unventilated recesses.</li> <li>➤ Ensure sufficient ventilation for dispersal of the heat.</li> </ul>

Do not operate the chambers in hazardous locations.



	 <b>DANGER</b>
	<p><b>Explosion hazard.</b> <b>Danger of death.</b></p> <ul style="list-style-type: none"> <li>⊘ Do NOT operate the chamber in potentially explosive areas.</li> <li>➤ KEEP explosive dust or air-solvent mixtures AWAY from the chamber.</li> </ul>

The chambers do not dispose of any measures of explosion protection.

	 <b>DANGER</b>
	<p><b>Explosion hazard.</b> <b>Danger of death.</b></p> <ul style="list-style-type: none"> <li>∅ Do NOT introduce any substance into the chamber which is combustible or explosive at working temperature.</li> <li>∅ NO explosive dust or air-solvent mixture in the inner chamber.</li> </ul>



Any solvent contained in the charging material must not be explosive or inflammable. I.e., irrespective of the solvent concentration in the steam room, NO explosive mixture with air must form. The temperature inside the chamber must lie below the flash point or below the sublimation point of the charging material. Familiarize yourself with the physical and chemical properties of the charging material, as well as the contained moisture constituent and its behavior with the addition of heat energy.

Familiarize yourself with any potential health risks caused by the charging material, the contained moisture constituent or by reaction products that may arise during the temperature process. Take adequate measures to exclude such risks prior to putting the chamber into operation.

	 <b>DANGER</b>
	<p><b>Electrical hazard.</b> <b>Danger of death.</b></p> <ul style="list-style-type: none"> <li>∅ The chamber must NOT become wet during operation or maintenance.</li> </ul>

The chambers were produced in accordance with VDE regulations and were routinely tested in accordance to VDE 0411-1 (IEC 61010-1).

During and shortly after operation, the temperature of the inner surfaces almost equals the set-point.

	 <b>CAUTION</b>
	<p><b>The glass doors and glass door handles (BD, BF), inner chamber, exhaust duct, door window (option), and the door gaskets will become hot during operation.</b></p> <p><b>Danger of burning.</b></p> <ul style="list-style-type: none"> <li>∅ Do NOT touch the glass doors, inner surfaces, exhaust duct, door window, access ports, door gaskets, or the charging material during operation.</li> <li>∅ BF, FD, FED: Do not place the power cable over the door gap when the chamber is hot after operation.</li> </ul>

## 1.6 Intended use

The chambers are suitable for exact tempering of harmless materials and for drying and heat treatment of solid or pulverized charging material, as well as bulk material, using the supply of heat. They can be used to dry e.g. glassware, and for warm storage of liquids in containers.

Because of their precise temperature accuracy the incubators BD and BF are especially useful for incubation of cultures at a standard temperature of 37 °C / 98.6 °F.

A solvent content must not be explosive or flammable. A mixture of any component of the charging material with air must NOT be explosive. The operating temperature must lie below the flash point or below the sublimation point of the charging material. Any component of the charging material must NOT be able to release toxic gases.

**Other applications are not approved.**

**The chambers are not classified as medical devices as defined by the Medical Device Directive 93/42/EEC.**

Do NOT use the chamber for drying processes when large quantities of vapor would form and result in condensation.



	Due to the special demands of the Medical Device Directive 93/42/EEC, these ovens are not qualified for sterilization of medical devices as defined by the directive.
---	---

	Observing the instructions in this operating manual and conducting regular maintenance work (chap. 13) is part of the intended use.
---	---

	<b>WARNING:</b> If customer should use a BINDER chamber running in non-supervised continuous operation, we strongly recommend in case of inclusion of irrecoverable specimen or samples to split such specimen or samples and store them in at least two chambers, if this is feasible.
--	---

	The charging material shall not contain any corrosive ingredients that may damage the machine components. Such ingredients include in particular acids and halides. Any corrosive damage caused by such ingredients is excluded from liability by BINDER GmbH.
---	--

The chambers do not dispose of any measures of explosion protection.

	 <b>DANGER</b>
	<p><b>Explosion or implosion hazard.</b></p> <p><b>Danger of poisoning.</b></p> <p><b>Danger of death.</b></p> <ul style="list-style-type: none"> <li>⊘ Do NOT introduce any substance combustible or explosive at working temperature into the chamber, in particular no energy sources such as batteries or lithium-ion batteries.</li> <li>⊘ NO explosive dust or air-solvent mixture in the inner chamber.</li> <li>⊘ Do NOT introduce any substance which could lead to release of toxic gases.</li> </ul>

In case of foreseeable use of the device there is no risk for the user through the integration of the chamber into systems or by special environmental or operating conditions in the sense of EN 61010-1:2010. For this, the intended use of the chamber and all its connections must be observed.

Connect only external devices to the chamber interfaces Ethernet (regular with FED, optional with BD, BF, ED, FD) and USB which are compliant with the standards EN 61010-1:2010 or EN 60950-1:2006 mod.

## 2. Chamber description

BINDER incubators BD and BF and drying and heating ovens ED, FD and FED are equipped with an electronic PID-controller with digital display.



The incubators BD and BF indicate the temperature with an accuracy of a tenth of a degree. The drying and heating ovens ED, FD and FED indicate the temperature with an accuracy of one degree.

All chambers are heated electrically. Incubators BD and drying and heating ovens ED are ventilated naturally. Incubators BF and drying and heating ovens FD and FED are ventilated by fan-assisted, forced-air circulation.

The concept of air conduction guarantees high level of spatial and time-based temperature precision, thanks to the direct and distributed air circulation into the interior. With BF, FD and FED, the fan supports exact attainment and maintenance of the desired temperature accuracy.

The chambers are regularly equipped with an overtemperature safety device class 1 acc. to DIN12880:2007 and with an overtemperature safety controller (overtemperature temperature safety device class 2 or class 3.1 acc. to DIN12880:2007), see chap. 7).

The inner chamber and the inside of the doors are made of stainless steel V2A (German material no. 1.4301, US equivalent AISI 304 and material no. 1.4016, US equivalent AISI 430). Drying and heating ovens ED, FD and FED: When operating the chambers at temperatures above 150 °C / 302 °F, the impact of the oxygen in the air may cause discoloration of the metallic surfaces (yellowish-brown or blue) by natural oxidation processes. These colorations are harmless and will in no way impair the function or quality of the chamber. The housing is RAL 7035 powder-coated. All corners and edges are also completely coated.

All chamber functions are easy and comfortable to use thanks to their clear arrangement. Major features are easy cleaning of all chamber parts and avoidance of undesired contamination.

The chambers are regularly (FED) or optionally equipped with an Ethernet interface for computer communication, e.g. via the communication software APT-COM™ 3 DataControlSystem (option, chap. 12.1) and with a USB interface to read out the measured values in real time.

The models size 720 are equipped with four castors. Both front castors can be locked by brakes.

Temperature ranges see technical data (chap. 16.4 - 16.8).

### 2.1 Chamber overview

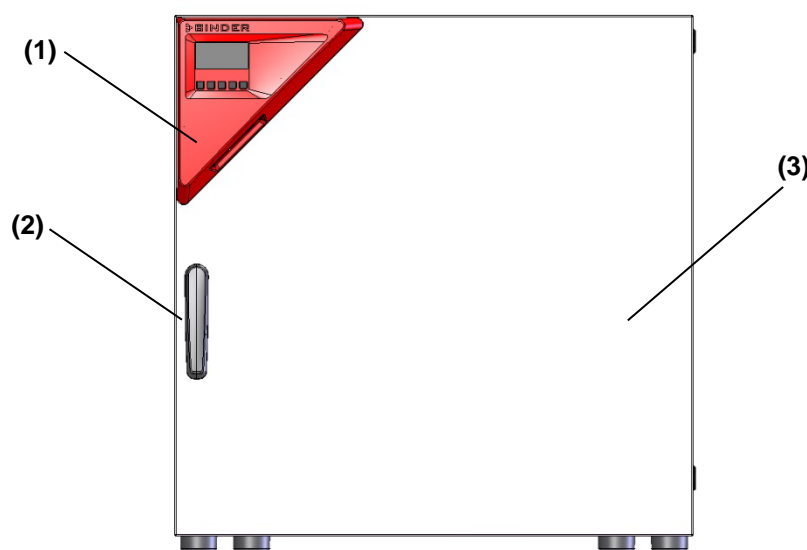

Figure 4: Overview, closed chamber (chamber with single door)



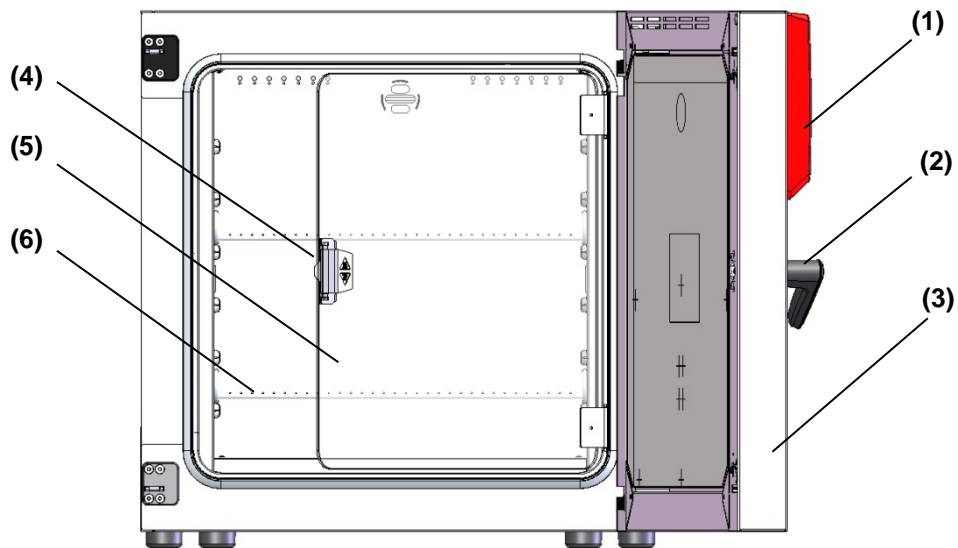

Figure 5: Overview, open chamber with glass door (chamber with single door) (BD, BF)

- (1) Triangular instrument panel with controller R4 and USB interface
- (2) Door handle
- (3) Outer door
- (4) Glass door handle (BD and BF)
- (5) Glass door (BD and BF)
- (6) Rack

## 2.2 Triangular instrument panel

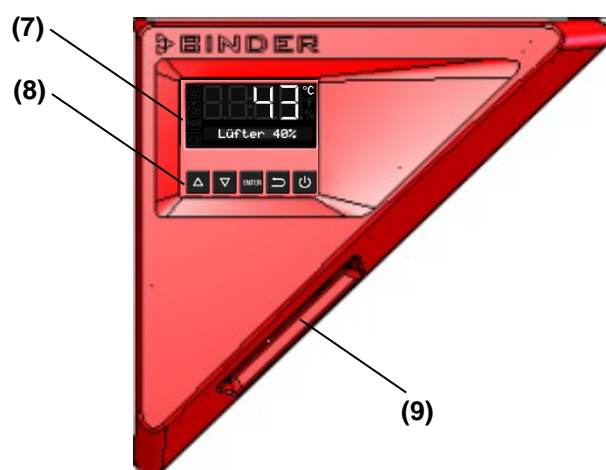

Figure 6: Triangular instrument panel

- (7) Controller display
- (8) Functional controller buttons
- (9) USB interface

## 2.3 Main power switch ED, FD, FED 720

The chambers ED, FD, FED size 720 are equipped with a main power switch located on the chamber rear.



Figure 7: Main power switch on the chamber rear



## 3. Completeness of delivery, transportation, storage, and installation

### 3.1 Unpacking, and checking equipment and completeness of delivery

After unpacking, please check the chamber and its optional accessories, if any, based on the delivery receipt for completeness and for transportation damage. Inform the carrier immediately if transportation damage has occurred.

The final tests of the manufacturer may have caused traces of the racks on the inner surfaces. This has no impact on the function and performance of the chamber.

Please remove any transportation protection devices and adhesives in/on the chamber and on the doors and take out the operating manuals and accessory equipment.

	 <b>CAUTION</b>
	<p><b>Sliding or tilting of the chamber.</b>  <b>Damage to the chamber.</b>  <b>Risk of injury by lifting heavy loads.</b></p> <ul style="list-style-type: none"> <li>⊘ Do NOT lift or transport the chamber using the door handle or the door.</li> <li>⊘ Do NOT lift chambers size 720 by hand</li> <li>➤ Lift the chamber size 56 and 115 from the pallet at its four lower corners with the aid of 2 people, chamber size 260 with the aid of 4 people.</li> <li>➤ Lift chambers size 720 from the pallet using technical devices (fork lifter). Set the fork lifter only from the rear in the middle of the chamber. Make sure to place all the lateral supports of the chamber on the forks.</li> </ul>

If you need to return the chamber, please use the original packing and observe the guidelines for safe lifting and transportation (chap. 3.2).

For disposal of the transport packing, see chap. 14.1.



#### Note on second-hand chambers (Ex-Demo-Units):

Second-hand chambers are chambers that have been used for a short time for tests or exhibitions. They are thoroughly tested before resale. BINDER ensures that the chamber is technically sound and will work flawlessly.

Second-hand chambers are marked with a sticker on the chamber door. Please remove the sticker before commissioning the chamber.

### 3.2 Guidelines for safe lifting and transportation

The front castors of chambers size 720 can be blocked by brakes. Please move the chambers with castors only when empty and on an even surface, otherwise the castors may be damaged. After operation please observe the guidelines for temporarily decommissioning the chamber (chap. 14.2).

	 <b>CAUTION</b>
	<p><b>Sliding or tilting of the chamber.</b>  <b>Damage to the chamber.</b>  <b>Risk of injury by lifting heavy loads.</b></p> <ul style="list-style-type: none"> <li>➤ Transport the chamber only in its original packaging.</li> <li>➤ Secure the chamber with transport straps for transport.</li> <li>⊘ Do NOT lift or transport the chamber using the door handle or the door.</li> <li>⊘ Do NOT lift chambers size 720 by hand</li> <li>➤ Lift chamber size 56 and 115 at its four lower corners with the aid of 2 people, chamber size 260 with the aid of 4 people, and place it on a transport pallet with wheels. Push the pallet to the desired site and then lift the chamber from the pallet at its four lower corners.</li> <li>➤ Place chamber size 720 using technical devices (fork lifter) on the transport pallet. Set the fork lifter only from the rear in the middle of the chamber. Make sure to place all the lateral supports of the chamber on the forks.</li> <li>➤ Transport chamber size 720 ONLY with the original transport pallet. Set the fork lifter only to the pallet. Without the pallet the chamber is in imminent danger of overturning!</li> </ul>

- Permissible ambient temperature range during transport: -10 °C to +60 °C / 14 °F to 140 °F.

You can order transport packing and pallets for transportation purposes from BINDER Service.

### 3.3 Storage

Intermediate storage of the chamber is possible in a closed and dry room. Observe the guidelines for temporary decommissioning (chap. 14.2).

- Permissible ambient temperature range during storage: -10 °C to +60 °C / 14 °F to 140 °F.
- Permissible ambient humidity: max. 70 % r.H., non-condensing

When after storage in a cold location you transfer the chamber to its warmer installation site, condensation may form. Before start-up, wait at least one hour until the chamber has attained ambient temperature and is completely dry.

### 3.4 Location of installation and ambient conditions

Set up the chamber on an even and non-flammable surface, free from vibration and in a well-ventilated, dry location and align it using a spirit level. The site of installation must be capable of supporting the chamber's weight (see technical data, chap. 16.4 to 16.7). The chambers are designed for setting up inside a building (indoor use).

	<b>CAUTION</b>
	<p><b>Danger of overheating.</b>  <b>Damage to the chamber.</b></p> <ul style="list-style-type: none"> <li>⊘ Do NOT set up chambers in non-ventilated recesses.</li> <li>➤ Ensure sufficient ventilation for dispersal of the heat.</li> </ul>

- Permissible ambient temperature range during operation: +18 °C up to +40 °C / 64.4 °F to 104 °F. At elevated ambient temperature values, fluctuations in temperature can occur.



The ambient temperature should not be substantially higher than the indicated ambient temperature of +25 °C / 77 °F to which the specified technical data relate. For other ambient conditions, deviations from the indicated data are possible.

- Permissible ambient humidity: 70 % r.H. max., non-condensing.
- Installation height: max. 2000 m / 6562 ft. above sea level.

When placing several chambers of the same size side by side, maintain a minimum distance of 250 mm / 9.84 in between each chamber. Wall distances: rear 160 mm / 6.30 in, sides 100 mm / 3.94 in. Spacing above the chamber of at least 100 mm / 3.94 in must also be accounted for.

Two devices up to size 115 can be stacked on top of each other. For this purpose place rubber pads under all four feet of the upper chamber to prevent the device from slipping.

	<b>CAUTION</b>
	<p><b>Sliding or tilting of the upper chamber.</b>  <b>Damage to the chambers.</b></p> <ul style="list-style-type: none"> <li>➤ When stacking, place rubber pads under all four feet of the upper chamber.</li> <li>➤ Stack only chambers of the same size.</li> </ul>



Chambers sizes 260 and 720 must NOT be stacked.

	<b>CAUTION</b>
	<p><b>Danger by stacking.</b>  <b>Damage to the chambers.</b></p> <ul style="list-style-type: none"> <li>⊘ Do NOT place chambers sizes 260 or 720 on top of each other.</li> </ul>

To completely separate the chamber from the power supply, you must disconnect the power plug. Install the chamber in a way that the power plug is easily accessible and can be easily pulled in case of danger. Do not conduct the power cable above the exhaust duct.

For the user there is no risk of temporary overvoltages in the sense of EN 61010-1:2010.

Do not install or operate the chamber in potentially explosive areas.

	 <b>DANGER</b>
	<p><b>Explosion hazard.</b>  <b>Danger of death.</b></p> <ul style="list-style-type: none"> <li>⊘ Do NOT operate the chamber in potentially explosive areas.</li> <li>➤ KEEP explosive dust or air-solvent mixtures AWAY from the vicinity of the chamber.</li> </ul>

## 4. Installation

### 4.1 Mounting the tilt protection holders (chambers with window)

For chambers equipped with the option „door with window“ it is recommended to install the supplied tilt protection.

**Scope of delivery of tilt protection kit (Art.no. 8009-0870):**

- 2 screws
- 2 tilt protection holders

#### Preparing the tilt protection holders

- Depending on the desired wall distance, you can bend the tilt protection holders accordingly.

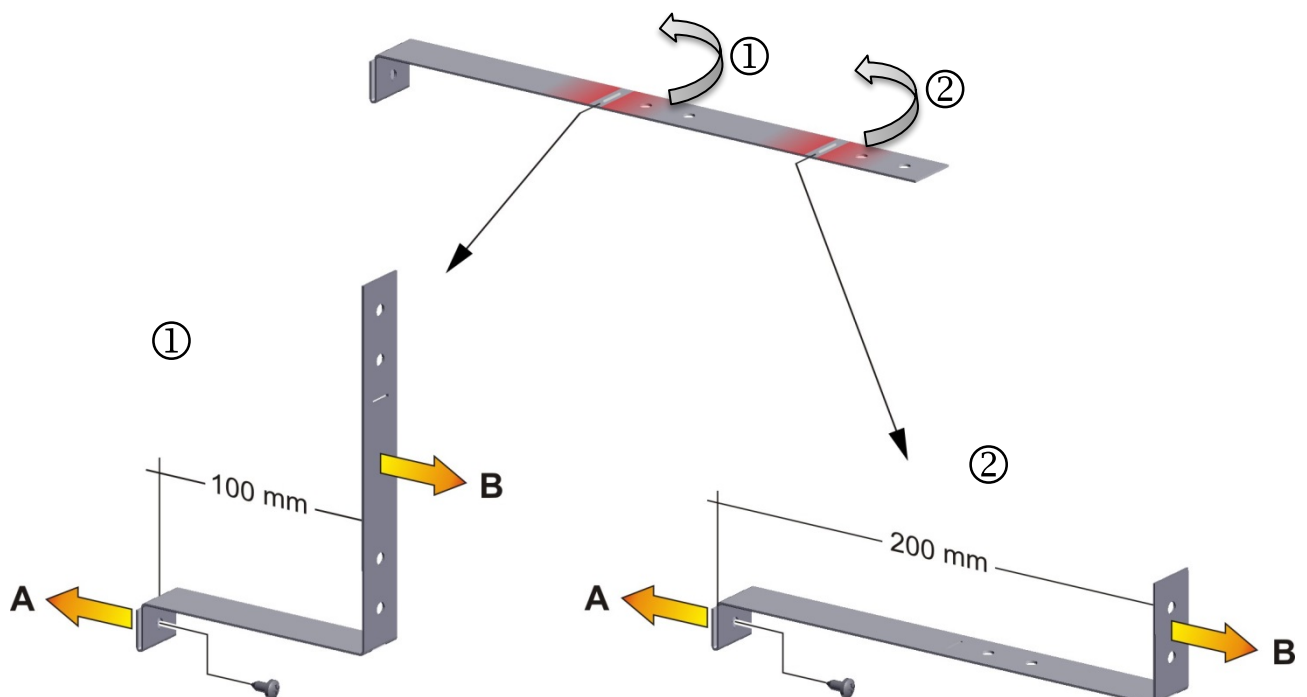

Figure 8: Variable length of the tilt protection holder depending on the bend

#### Installation on the chamber

- Plug the two tilt protection holders each with the tab on the provided spot on the edge of the rear panel. The screw holes in the rear wall and in the tilt protection holders must align.
- Fix the tilt protection holders each with one of the supplied screws on the chamber rear wall.

#### Wall mounting

- Then fix both tilt protection holders on the wall, each with 2 screws  $\varnothing$  6mm suitable for the wall (B)

## 4.2 Electrical connection

The chambers are supplied ready for connection and come with an IEC connector plug.

Model	Power plug of the power cable	Nominal voltage +/- 10% at the indicated power frequency	Current type	Chamber fuse
BD056-230V BF056-230V	Shockproof plug	230 V at 50 Hz 230 V at 60 Hz	1N~	6,3 A
ED056-230V FD056-230V FED056-230V	Shockproof plug	230 V at 50 Hz 230 V at 60 Hz	1N~	6,3 A
BD115-230V BF115-230V	Shockproof plug	230 V at 50 Hz 230 V at 60 Hz	1N~	6,3 A
ED115-230V FD115-230V FED115-230V	Shockproof plug	230 V at 50 Hz 230 V at 60 Hz	1N~	6,3 A
BD260-230V BF260-230V	Shockproof plug	230 V at 50 Hz 230 V at 60 Hz	1N~	8,0 A
ED260-230V FD260-230V FED260-230V	Shockproof plug	230 V at 50 Hz 230 V at 60 Hz	1N~	12,5 A
BD720-230V BF720-230V	Shockproof plug	230 V at 50 Hz 230 V at 60 Hz	1N~	12,5 A
ED720-400V FD720-400V FED720-400V	Shockproof plug	400 V at 50 Hz 400 V at 60 Hz	3N~	---
BD056UL-120V BF056UL-120V	NEMA 5-15P	115 V at 50 Hz 115 V at 60 Hz	1N~	12,5 A
ED056UL-120V FD056UL-120V FED056UL-120V	NEMA 5-15P	115 V at 50 Hz 115 V at 60 Hz	1N~	12,5 A
BD115UL-120V BF115UL-120V	NEMA 5-15P	115 V at 50 Hz 115 V at 60 Hz	1N~	12,5 A
ED115UL-120V FD115UL-120V FED115UL-120V	NEMA 5-15P	115 V at 50 Hz 115 V at 60 Hz	1N~	12,5 A
BD260UL-120V BF260UL-120V	NEMA 5-15P	115 V at 50 Hz 115 V at 60 Hz	1N~	12,5 A
ED260UL-240V FD260UL-240V FED260UL-240V	NEMA 6-20P	240 V at 50 Hz 240 V at 60 Hz	2~	---
BD720UL-240V BF720UL-240V	NEMA 6-20P	240 V at 50 Hz 240 V at 60 Hz	2~	---
FED720UL-208V	NEMA L21-20P	208 V at 50 Hz 208 V at 60 Hz	3N~	---

- The domestic socket must also provide a protective conductor. Make sure that the connection of the protective conductor of the domestic installations to the chamber's protective conductor meets the latest technology. The protective conductors of the socket and plug must be compatible!
- Prior to connection and start-up, check the power supply voltage. Compare the values to the specified data located on the chamber's type plate (left-hand side of the chamber, chap. 1.4).
- When connecting, please observe the regulations specified by the local electricity supply company and as well as the VDE directives (for Germany). We recommend the use of a residual current circuit breaker.
- Only use original connection cables from BINDER.
- BF, FD, FED: Do not place the power cable over the door gap when the chamber is hot after operation.
- Pollution degree (acc. to IEC 61010-1): 2
- Over-voltage category (acc. to IEC 61010-1): II

	<b>CAUTION</b>
	<p><b>Danger of incorrect power supply voltage.</b> Damage to the equipment.</p> <ul style="list-style-type: none"> <li>➤ Check the power supply voltage before connection and start-up.</li> <li>➤ Compare the power supply voltage with the data indicated on the type plate.</li> </ul>

See also electrical data (chap. 16.4 to 16.7).

	<p>To completely separate the chamber from the power supply, you must disconnect the power plug. Install the chamber in a way that the power plug is easily accessible and can be easily pulled in case of danger.</p>
--	--

### 4.3 Connection to an exhaust/ventilation system (optional)

Active suction from the chamber must only be effected together with external air. Therefore, the chamber's exhaust air duct shall not be immediately connected to an active exhaust system.



When connecting to an active exhaust system, proceed as follows:

- Perforate the connecting piece between the exhaust air duct and the exhaust system.

Or

- Use an exhaust air funnel placed in a distance of 3-5 cm / 1 to 2 in from the exhaust air duct. The funnel's opening must be at least twice as large as the diameter of the exhaust air duct.

	<p>If improperly connected to an active exhaust/ventilation system, the spatial temperature exactitude (uniformity), the heating-up and recovering times as well as the maximum temperature of the chamber may be negatively affected.</p>
---	--

	 <b>CAUTION</b>
	<p><b>The exhaust duct will become hot during operation.</b> <b>Danger of burning.</b></p> <p>∅ Do NOT touch the exhaust duct during operation.</p>

## 5. Start up

Insert the plug into a suitable socket (chap. 4.2).

BF, FD, FED size 720: Turn the chamber at the main power switch (chap. 2.3).



If there is no other indication on the controller than the standby symbol, press the standby button until the display lights up.

The controller now shows normal display (chap. 6.2). If a timer function was active prior to turning off the chamber, it is shown in the controller display.



Warming chambers may release odors in the first few days after commissioning. This is not a quality defect. To reduce odors quickly we recommend heating up the chamber to its nominal temperature for one day and in a well-ventilated location.

### 5.1 Behavior when opening the door

BD, ED: Depending on the temperature, heating performance may be adapted when opening the door.





BF, FD, FED: When opening the door, heating and fan turn off as long as the door remains open.





## 6. Overview and general settings on the R4 controller



### 6.1 Controller overview



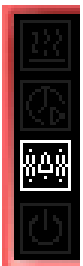
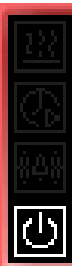









Buttons on the controller	
	The <b>arrow buttons</b> serve to navigate and to enter the values
	The <b>OK button</b> serves to select the parameters and to confirm the entered values
	The <b>Back button</b> serves to reach the preceding level
	If the <b>Standby button</b> is pressed down for approx. 3 seconds, the display changes to standby mode. To activate the display, press down the standby button again for approx. 3 seconds
	 Display in standby mode with standby symbol

Status symbols on the controller display			
	Heating active		Timer operation
			Overtemperature alarm of the safety controller
			Standby mode

### 6.2 Normal display

	Normal display with chambers without fan (BD, ED) or with fixed fan speed (FD)
	Normal display with chambers with adjustable fan speed (BF, FED)





### 6.3 Setting the menu language





<p>without fan <b>5x</b> </p> <p>with fan <b>6x</b> </p>	<p>From Normal display</p> <p>with the arrow-up button to the user menu</p>
	Confirm with OK.
	Enter the password (factory setting: 00 00) and confirm each entry with OK.
<b>4 x</b> 	with the arrow-up button to the <b>language setting</b> menu.
	The current menu language is shown.
	Press OK to select the menu language.
	The setting flashes.
	Select the setting with the arrow buttons
	and confirm with OK.
<b>2x</b> 	Back to Normal display.





There are the following options:

<p>German:</p> 	<p>English:</p> 	<p>French:</p> 
--	---	---

## 6.4 Setting date and time













<p>without fan <b>5x</b> </p> <p>with fan <b>6x</b> </p>	<p>From Normal display</p> <p>with the arrow-up button to the user menu</p>
	<p>Confirm with OK.</p>
	<p>Enter the password (factory setting: 00 00) and confirm each entry with OK.</p>
	<p>The current date is shown.</p>

	<p>Press OK to <b>set the year</b>.</p>
	<p>The setting flashes.</p>
	<p>Enter the year with the arrow buttons (any setting)</p>
	<p>and confirm with OK.</p>

	<p>Press OK to <b>set the month</b>.</p>
	<p>The setting flashes.</p>
	<p>Enter the month with arrow buttons (1 to 12)</p>
	<p>and confirm with OK.</p>



Without the optional real time clock, these settings must be repeated when the power supply is interrupted..

	Press OK to <b>set the day</b> .
	The setting flashes.
	Enter the day with arrow buttons (1 to 31)
	and confirm with OK.
	Press OK to <b>set the hour</b> .
	The setting flashes.
	Enter the hour with arrow buttons (0 to 23)
	and confirm with OK.
	Press OK to <b>set the minute</b> .
	The setting flashes.
	Enter the minute with arrow buttons (0 to 59)
	and confirm with OK.
<b>2x</b> 	Back to Normal display.











## 6.5 Selecting the temperature unit

You can choose between degrees Celsius °C and degrees Fahrenheit °F.





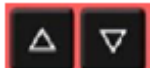









If the unit is changed, the temperature set-point and limits are converted accordingly.

Also when specifying the ramp function (see chap. 9) this setting is accordingly taken as the basis.

	C = degrees Celsius	0 °C = 31°F	Conversion: [Value in °F] = [Value in °C] * 1.8 + 32
	F = degrees Fahrenheit	100 °C = 212°F	

without fan <b>5x</b>  with fan <b>6x</b> 	From Normal display with the arrow-up button to the user menu
	Confirm with OK.
	Enter the password (factory setting: 00 00) and confirm each entry with OK.
	With the arrow-up button to the <b>temperature unit selection</b> menu.
	The current temperature unit is shown.
	Press OK to select the temperature unit.
	The setting flashes.
	Select the setting with arrow buttons
	and confirm with OK.
<b>2x</b> 	Back to Normal display.

## 6.6 Set-point entry for temperature and fan speed

	<p>From Normal display with the arrow-up button to the <b>Set-point entry</b> menu.</p>
	<p>The current temperature set-point is displayed.</p>
	<p>Press OK to enter the temperature set-point.</p>
	<p>The temperature set-point flashes.</p>
	<p>Enter the temperature set-point with arrow buttons with an accuracy of a tenth of a degree (BD, BF) or of one degree (ED, FD, FED)</p>
	<p>and confirm with OK.</p>
 or 	<p>Back to Normal display. with chambers with adjustable fan speed (BF, FED): go on to enter the fan speed.</p>
	<p>The fan speed set-point is displayed.</p>
	<p>Press OK to enter the fan speed</p>
	<p>The fan speed set-point flashes</p>
	<p>Adjust the fan speed in steps of 10 % with arrow buttons</p>
	<p>and confirm with OK.</p>
	<p>Back to Normal display.</p>
	<p>Check and/or adjust the safety controller following any changes of the set-point (chap. 7).</p>

### 6.6.1 Set-point entry for temperature in two-door chambers (ED, FD, FED 720)

With two-door chambers (ED, FD, FED 720) the maximum adjustable temperature set-point depends on the ambient temperature:

- Range from 18 °C up to 26 °C: maximum temperature set-point: 300 °C
- Range from above 26 °C up to 40 °C: maximum temperature set-point decreasing with increasing ambient temperature

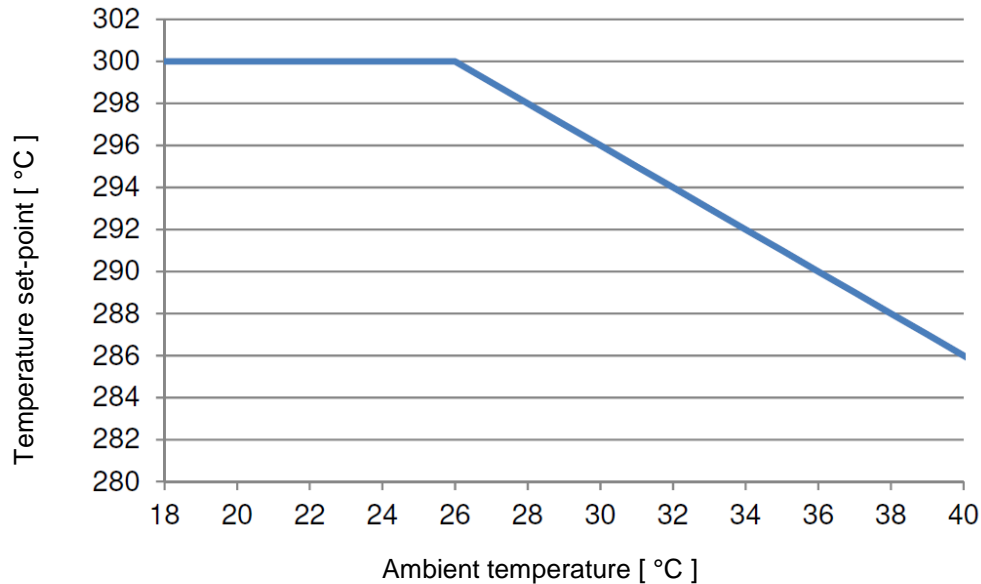

Figure 9: Maximum temperature set-point depending on the ambient temperature

Ambient temperature	Maximum temperature set-point
18 °C bis 26 °C	300 °C
28 °C	298 °C
30 °C	296 °C
32 °C	294 °C
34 °C	292 °C
36 °C	290 °C
38 °C	288 °C
40 °C	286 °C







This ensures the maximum lifetime of the controller.

## 6.7 Adjusting the air flap position



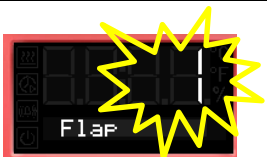



Opening the air flap in the exhaust duct serves to adjust the air change.

The position of the air flap in the exhaust duct serves to adjust the fresh air entry. With the open the air flap, fresh air can enter through the fresh air tube. For chambers with fan, fan operation will increase fresh air entry.

If the air flap is completely open, the spatial temperature accuracy can be negatively influenced.

without fan <b>2x</b>  with fan <b>3x</b>	From Normal display with the arrow-up button to the <b>Adjusting the air flap position</b> menu.
	The current air flap position is shown.
	Press OK to select the air flap position.
	The setting flashes.
	Select the position with arrow buttons
	and confirm with OK.
	Back to Normal display.

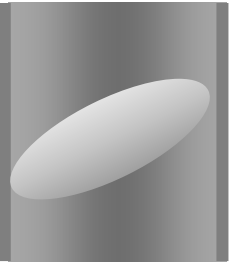
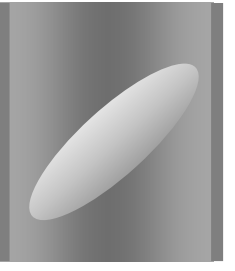
There are the following options:

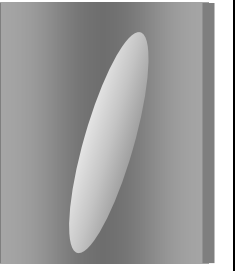
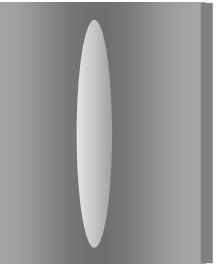
Air flap closed	Air flap slightly opened	Air flap half opened	Air flap almost open	Air flap open
				
				

The setting can be done in steps of 15°.



## 6.8 Changing the passwords for user level and general controller functions

In this menu you can change the passwords for access to the user menu and to all controller functions.



















You can set two passwords for different access levels:





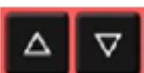

**L1** (level 1): The password enables access control to the user level

**L2** (level 2): The password enables access control to all controller functions

Factory setting for both passwords is 00 00 (no password assigned).

As soon as a password has been assigned, access to the respective functions is blocked and only available after entering the correct password.

without fan <b>5x</b>  with fan <b>6x</b> 	From Normal display with the arrow-up button to the user menu	
	Confirm with OK.	
	Enter the password (factory setting: 00 00) and confirm each entry with OK.	
<b>2 x</b> 	With the arrow-up button to the <b>password setting menu</b> .	
	Password <b>L1</b> for access to the user level. Confirm with OK.	
	The current password level <b>L1</b> is shown. The setting flashes. You can change between <b>L1</b> and <b>L2</b> with arrow buttons.	 
	Select the setting with arrow buttons (if desired)	 
	and confirm with OK.	 
	The current password for the selected password level is shown. The left two digits are flashing.	
	Enter the desired numbers with arrow buttons,	
	confirm with OK and go on.	

	<p>The right two digits of the password are flashing.</p>	
	<p>Enter the desired numbers with arrow buttons</p>	
	<p>and confirm with OK.</p>	
	<p>The modified password (L1 or L2 depending on the selection) is shown (example: L1).</p>	
		<p>If you want to change between <b>L1</b> and <b>L2</b>, confirm with OK. Thereafter you can change to the other password level and also modify the password.</p>
<p><b>2x</b></p> 	<p>Back to Normal display.</p>	



Keep in mind any modification of the password. There is no access to the user menu without the correct password L1. Without the correct password L2 access control to all controller functions is blocked.

## 7. Overtemperature protection

### 7.1 Overtemperature protective device (class 1)

The chambers are regularly equipped with an overtemperature protective device (safety device class 1 acc. to DIN 12880:2007). It serves to protect the chamber, its environment and the contents against exceeding the maximum permissible temperature. When a defined temperature is reached, which is approx. by 20 °C to 30 °C above the chamber's nominal temperature, the overtemperature protective device turns off the heating.

Cut-off temperature values:

BD, BF: 120 °C

ED 260: 320 °C

ED 56, ED 115, FD 56, FED 56: 330 °C

FD 115, FD 260, FED 115, FED 260: 350 °C

The message "Overtemperature" is displayed on the controller.



If the overtemperature protective device class 1 has turned off the heating, proceed as follows:

- Disconnect the chamber from the power supply for at least 10 seconds (pull the power plug).
- If appropriate, have an expert examine and rectify the cause of the fault.
- Let the chamber cool down
- Restart the chamber.

As soon as the inner chamber temperature after restart is below the defined cut-off temperature of the overtemperature protective device class 1, the alarm message is deleted automatically.

Reset temperature values:

BD, BF: 90 °C

ED 260: 220 °C

ED 56, ED 115, FD 56, FED 56: 230 °C

FD 115, FD 260, FED 115, FED 260: 250 °C

## 7.2 Safety controller

The chambers are regularly equipped with an adjustable electronic safety controller. It serves to protect the chamber, its environment and the contents against exceeding the maximum permissible temperature. Please observe the DGUV guidelines 213-850 on safe working in laboratories (formerly BGI/GUV-I 850-0, BGR/GUV-R 120 or ZH 1/119, issued by the employers' liability insurance association) (for Germany).

Depending on the chamber type the safety controller acts as an over temperature safety device class 2 ("temperature limiter") or class 3.1 ("temperature protection") acc. to DIN 12880:2007.



Check the setting regularly and adjust it following any changes of the set-point.

- **Safety controller class 2 ("temperature limiter") with ED, FD and FED**

The safety controller class 2 limits the temperature inside the chamber to the entered safety controller set-point. In the event of a fault (if this maximum temperature is exceeded) the safety controller completely turns off the heating until manual reset. This status is reported visually by an alarm message and, in case of the option audible alarm with activated buzzer (chap. 7.6) additionally by the buzzer sounding.

If the safety controller class 2 has turned off the heating, we recommend proceeding as follows:

- Disconnect the chamber from the power supply.
- Have an expert examine and rectify the cause of the fault.
- Restart the chamber
- Reset the alarm message

- **Safety controller class 3.1 ("temperature protection") with BD and BF**

The safety controller class 3.1 limits the temperature inside the chamber to the entered safety controller set-point. In the event of a fault (if this maximum temperature is exceeded), it takes over the control to this value. This status is reported visually by an alarm message and, in case of the option audible alarm with activated buzzer (chap. 7.6) additionally by the buzzer sounding.

The safety controller keeps control of the chamber until the chamber temperature cools down below the safety controller set-point value.

If the safety controller class 3.1 has taken over control, we recommend proceeding as follows:

- Disconnect the chamber from the power supply.
- Have an expert examine and rectify the cause of the fault.
- Restart the chamber
- Reset the alarm message

### Function check:









Check the safety controller at appropriate intervals for its functionality. It is recommended that the authorized operating personnel should perform such a check, e.g., before starting a longer work procedure.

### 7.3 Setting the safety controller set-point

A limit temperature is entered as the safety controller set-point, i.e. the absolute maximum permitted temperature value.

Example: Temperature set-point 45 °C, safety controller set-point 50 °C.

	<p>Regularly check the safety controller setting relating to the entered temperature set-point Set the safety controller set-point by approx. 2 °C to 5 °C above the desired temperature set-point.</p>
---	---

<p>without fan <b>4x</b> </p> <p>with fan <b>5x</b> </p>	<p>From Normal display with the arrow-up button to the <b>Safety controller set-point setting</b> menu.</p>
	<p>The current safety controller set-point is shown (class 2 “temperature limiter” or class 3.1 “temperature protection” depending on the chamber type).</p>
	<p>Press OK to enter the safety controller set-point.</p>
	<p>The safety controller set-point flashes.</p>
	<p>Enter the safety controller set-point with arrow buttons: 10 °C up to 100 °C (with an accuracy of a tenth of a degree) with BD, BF 10 °C up to 300 °C (with an accuracy of one degree) with ED, FD, FED</p>
	<p>and confirm with OK.</p>
	<p>Back to Normal display.</p>

## 7.4 Alarm message and proceeding in case of an alarm

The alarm icon flashes in the display. In case of the option audible alarm with activated buzzer (chap. 7.6) the buzzer sounds.

- Safety controller class 2 (“temperature limiter”)



The alarm icon flashes in the display. In case of the option audible alarm with activated buzzer (chap. 7.6) the buzzer sounds.

The heating turns off.

### Resetting the alarm:

With option audible alarm with activated buzzer: Mute the buzzer pressing the OK button.

As soon as the inner chamber temperature has cooled down below the safety controller set-point, the alarm icon is lit permanently. You can reset the alarm message on the controller. To do this, reset the alarm message in the safety controller menu with the OK button. The heating is released and temperature control is resumed by the controller.

- Safety controller class 3.1 (“temperature protection”)



The alarm icon flashes in the display. In case of the option audible alarm with activated buzzer (chap. 7.6) the buzzer sounds.

The heating turns off.

### Resetting the alarm:

With option audible alarm with activated buzzer: Mute the buzzer pressing the OK button.

As soon as the inner chamber temperature has cooled down below the safety controller set-point, You can reset the alarm message in the safety controller menu with the OK button, The heating is released and temperature control is resumed by the controller.

### Note:

When the safety controller class 2 or class 3.1 had been activated, you should disconnect the chamber from the power supply and have an expert examine and rectify the cause of the fault.

## 7.5 Function check











Check the temperature safety device class 2 or class 3.1 at appropriate intervals for its functionality. It is recommended that the authorized operating personnel should perform such a check, e.g., before starting a longer work procedure

## 7.6 Disconnectable audible over-temperature alarm (option)



This option permits activating an audible signal:

If the buzzer is activated, an audible signal sounds when the limit temperature set at the safety controller is exceeded. This happens in addition to the alarm message on the controller display.

	Turning off the audible alarm does not influence the safety controller's function.
---	--

without fan <b>5x</b>  with fan <b>6x</b> 	From Normal display with the arrow-up button to the user menu
	Confirm with OK.
	Enter the password (factory setting: 00 00) and confirm each entry with OK.
<b>5 x</b> 	With the arrow-up button to the <b>alarm buzzer setting</b> menu
	The current setting is shown.
	Press OK to select the alarm buzzer setting
	The setting flashes.
	Select the setting with arrow buttons
	and confirm with OK.
	Back to Normal display.



There are the following options

Alarm buzzer On 	Alarm buzzer Off 
--	---

## 8. Timer functions

### 8.1 Selecting the timer function

There are up to three 3 timer functions:

	<p><b>Timer function “Delayed Off”</b></p> <p>The selected timer run-time immediately starts running down. When the timer expires the heating turns off. Chambers with fan: The fan may continue working according to the selections made.</p>
	<p><b>Timer function “Temperature dependent Delayed Off”</b></p> <p>The selected timer run-time only starts running down, when the actual value reached or exceeds the selected set-point. When the timer expires the heating turns off. Chambers with fan: The fan may continue working according to the selections made.</p>
	<p><b>Timer function “Delayed On”</b></p> <p>The selected timer run-time immediately starts running down, the heating turns off. Chambers with fan: The fan may be working according to the selections made. When the timer expires the heating turns on and remains in continuous operation.</p>

The chambers BD, ED and FD offer the timer function “Delayed Off”

The chambers BF and FED offer all the three timer functions.



Stage	Heating	Fan (Chamber with fixed fan speed: FD)	Fan (Chambers with adjustable fan speed: BF, FED)
<b>Timer function “Delayed Off”</b>			
Timer running	Control to the temperature set-point	On (100 %)	Rotation speed according to fan speed set-point
After the timer expired	Off	On (100 %) or Off (0 %) acc. to selection	Rotation speed according to setting of timer function
<b>Timer function “Temperature dependent Delayed Off”</b>			
Possibly heating-up phase until the temperature set-point is reached	Control to the temperature set-point	---	Rotation speed according to fan speed set-point
Timer running	Control to the temperature set-point	---	Rotation speed according to fan speed set-point
After the timer expired	Off	---	Rotation speed according to setting of timer function
<b>Timer function “Delayed On”</b>			
Timer running	Off	---	Rotation speed according to setting of timer function
After the timer expired	Control to the temperature set-point	---	Rotation speed according to fan speed set-point



### General information on the setting:









In the setting menus of the timer functions, it is always required to confirm **all** parameters with OK, otherwise all entries made will be lost.



Timer run-time is set in days, hours, and minutes. If days have been entered, they are shown in the controller display preceded by an underscore:

	Setting: 0 days (not shown), 10 hours, 30 minutes		Setting: 2 days, 10 hours (minutes not shown)
---	---	--	---

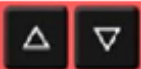

## 8.2 Timer function “Delayed Off”

### 8.2.1 Entry and activation of the timer run-time and fan setting

	From Normal display with the arrow-down button to the <b>Timer function “Delayed Off”</b> menu (with connected USB device: press the arrow-down button twice)
	Current Timer function “Delayed Off”
	Confirm with OK and go on to enter the <b>days of the timer run-time.</b>
	The current timer run-time (days) is shown. The day value flashes.
	Enter the days of the timer run-time (0 up to 9)
	confirm with OK and go on to enter the <b>hours of the timer run-time</b>
	The hour value flashes.
	Enter the hours of the timer run-time (0 up to 23)
	confirm with OK and go on to enter the <b>minutes of the timer run-time</b>





	<p>The minute value flashes.</p>
	<p>Enter the minutes of the timer run-time (0 up to 59)</p>
	<p>and confirm with OK.</p>





**Chambers without fan (BD, ED):**

	<p>The timer function "Delayed Off" is activated</p>
	<p>Back to Normal display.</p>

**Chamber with fixed fan speed (FD):**

Select whether the fan shall operate or not after the timer has expired



	<p>The current setting of the fan operation is shown</p>
	<p>Select fan operation: On (100 %) or Off (0 %)</p>
	<p>and confirm with OK.</p>
	<p>The timer function "Delayed Off" is activated</p>
	<p>Back to Normal display.</p>

<b>Chambers with adjustable fan speed (BF, FED):</b> Enter the fan speed set-point valid for the time after the timer has expired.	
	The current fan speed set-point is shown
	Enter the fan speed in steps of 10 % 0 % and 40 % up to 100 %
	and confirm with OK.
	The timer function "Delayed Off" is activated
	Back to Normal display.

#### Normal display during timer operation with timer function „Delayed Off“

	The timer run-time until turning off the heating is running down.
--	---

#### Normal display after the timer has expired:

	<b>Chambers without fan (BD, ED):</b> Timer function "Delayed Off". The timer has expired. The heating is off.
	<b>Chamber with fixed fan speed (FD):</b> Timer function "Delayed Off". The timer has expired. The heating is off. The fan is operating (On) or not (Off), as selected
	<b>Chambers with adjustable fan speed (BF, FED):</b> Timer function "Delayed Off". The timer has expired. The heating is off. The fan operates with the selected fan speed.

When the timer has expired, the heating is off. The chamber cools down to ambient temperature.

To restart the chamber you need to turn off the timer function (chap. 8.2.2)

### 8.2.2 Turning off the timer function or changing the settings







To turn off the timer function "Delayed Off" during the time when it is still running, set all time values (days, hours, minutes) to zero in the according menu (terminating the timer function). As long as the timer is running, the timer function settings can be subsequently modified in this menu.

After the timer expired you can turn off the timer function by pressing the OK button. Alternatively you can also set the time to zero in the according menu.







### Turning off the timer function when the timer has expired

In Normal display press the OK button.

Alternatively you can set the time to zero:









	<p>From Normal display with the arrow-down button to the <b>Timer function “Delayed Off”</b> menu (with connected USB device: press the arrow-down button twice)</p>
 or  or 	<p><b>Chambers without fan (BD, ED):</b> Timer function “Delayed Off”, the timer has expired. The heating is off.</p> <p><b>Chamber with fixed fan speed (FD):</b> Timer function “Delayed Off”, the timer has expired. The heating is off. The fan is operating (On) or not (Off), as selected</p> <p><b>Chambers with adjustable fan speed (BF, FED):</b> Timer function “Delayed Off”, the timer has expired. The heating is off. The fan operates with the selected fan speed.</p>
	<p>Confirm the timer function “Delayed Off” with OK</p>
<p>see chap. 8.2.1</p>	<p>Set all time values to zero</p>
<p><b>2x</b> </p>	<p>Back to Normal display.</p>





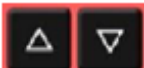



### Changing or terminating the timer function when the timer is running:

	<p>From Normal display with the arrow-down button to the <b>Timer function “Delayed Off”</b> menu (with connected USB device: press the arrow-down button twice)</p>
 or  or 	<p><b>Chambers without fan (BD, ED):</b> Timer function „Delayed Off”, the timer is running.</p> <p><b>Chamber with fixed fan speed (FD):</b> Timer function “Delayed Off”, the timer is running.</p> <p><b>Chambers with adjustable fan speed (BF, FED):</b> Timer function “Delayed Off”, the timer is running.</p>
	<p>Confirm the timer function “Delayed Off” with OK</p>
<p>see chap. 8.2.1</p>	<p>Modify the time values or set them to zero to terminate the timer function</p>
<p><b>2x</b> </p>	<p>Back to Normal display.</p>

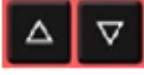

### 8.3 Timer function “Temperature dependent Delayed Off” (BF, FED)

#### 8.3.1 Entry and activation of the timer run-time, fan setting and set-point entry

<p>3 x </p>	<p>From Normal display with the arrow-down button to the <b>Timer function “Temperature dependent Delayed Off”</b> menu (with connected USB device: press the arrow-down button 4 times)</p>
	<p>Current Timer function “Temperature dependent Delayed Off”</p>
	<p>Confirm with OK and go on to enter the <b>days of the timer run-time</b>.</p>
	<p>The current timer run-time (days) is shown. The day value flashes.</p>
	<p>Enter the days of the timer run-time (0 up to 9)</p>
	<p>confirm with OK and go on to enter the <b>hours of the timer run-time</b></p>
	<p>The hour value flashes.</p>
	<p>Enter the hours of the timer run-time (0 up to 23)</p>
	<p>confirm with OK and go on to enter the <b>minutes of the timer run-time</b></p>
	<p>The minute value flashes.</p>
	<p>Enter the minutes of the timer run-time (0 up to 59)</p>
	<p>confirm with OK and go on to enter the <b>temperature set-point</b></p>

	<p>The temperature set-point flashes. When the set-point is reached, the timer starts running down.</p>
	<p>Enter the temperature set-point,</p>
	<p>confirm with OK and go on to enter the fan speed set-point valid for the time after the timer has expired</p>
	<p>The current fan speed is shown</p>
	<p>Enter the fan speed in steps of 10 % 0 % and 40 % up to 100 %</p>
	<p>and confirm with OK.</p>
	<p>The timer function "Temperature dependent Delayed Off" is activated</p>
	<p>Back to Normal display.</p>

#### Normal display during timer operation with timer function „Temperature dependent Delayed Off“

	<p>Normal display while the timer is running If the entered set-point exceeds the current actual value, the chamber heats up.</p>
 	<p>As soon as the set-point is reached or exceeded, the timer starts running down Normal display during the timer run-time. The timer run-time until turning off the heating (and possibly the fan) is running.</p>

#### Normal display after the timer has expired:

	<p>Timer function "Temperature dependent Delayed Off". The timer has expired. The heating is off. The fan operates with the selected fan speed.</p>
---	---

When the timer has expired, the heating is off. The chamber cools down to ambient temperature.  
To restart the chamber you need to turn off the timer function (chap. 8.3.2).

### 8.3.2 Turning off the timer function or changing the settings





To turn off the timer function “Temperature dependent Delayed Off” during the time when it is still running, set all time values (days, hours, minutes) to zero in the according menu (terminating the timer function). As long as the timer is running, the timer function settings can be subsequently modified in this menu.

After the timer expired you can turn off the timer function by pressing the OK button. Alternatively you can also set the time to zero in the according menu.





#### Turning off the timer function when the timer has expired

In Normal display press the OK button.

Alternatively you can set the time to zero:











<p>3 x </p>	<p>From Normal display with the arrow-down button to the <b>Timer function “Temperature dependent Delayed Off”</b> menu (with connected USB device: press the arrow-down button 4 times)</p>
	<p>Timer function “Temperature dependent Delayed Off”, the timer has expired</p>
	<p>Confirm the timer function “Temperature dependent Delayed Off” with OK</p>
<p>see chap. 8.3.1</p>	<p>Set all time values to zero</p>
	<p>Back to Normal display</p>

#### Changing or terminating the timer function when the timer is running:

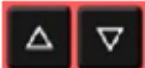

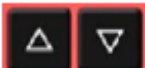

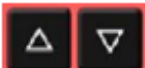
<p>3 x </p>	<p>From Normal display with the arrow-down button to the <b>Timer function “Temperature dependent Delayed Off”</b> menu (with connected USB device: press the arrow-down button 4 times)</p>
	<p>Timer function “Temperature dependent Delayed Off”, the timer is running</p>
	<p>Confirm the timer function “Temperature dependent Delayed Off” with OK</p>
<p>see chap. 8.3.1</p>	<p>Modify the time values or set all time values to zero to terminate the timer function</p>
	<p>Back to Normal display</p>

## 8.4 Timer function “Delayed On” (BF, FED)

### 8.4.1 Entry and activation of the timer run-time and fan setting

<p>2 x </p>	<p>From Normal display with the arrow-down button to the <b>Timer function “Delayed On”</b> menu (with connected USB device: press the arrow-down button 3 times)</p>
	<p>Current timer function “Delayed On”</p>
	<p>Confirm with OK and go on to enter the <b>fan speed set-point</b> valid during the time the timer is running</p>
	<p>The current fan speed set-point is shown</p>
	<p>Enter the fan speed in steps of 10 % 0 % and 40 % up to 100 %</p>
	<p>Confirm with OK and go on to enter the <b>days of the timer run-time</b>.</p>
	<p>The current timer run-time (days) is shown. The day value flashes.</p>
	<p>Enter the days of the timer run-time (0 up to 9)</p>
	<p>confirm with OK and go on to enter the <b>hours of the timer run-time</b></p>
	<p>The hour value flashes.</p>
	<p>Enter the hours of the timer run-time (0 up to 23),</p>
	<p>confirm with OK and go on to enter the <b>minutes of the timer run-time</b></p>



	<p>The minute value flashes.</p>
	<p>Enter the minutes of the timer run-time (0 up to 59)</p>
	<p>confirm with OK and go on to <b>enter the temperature set-point</b></p>
	<p>The temperature set-point flashes.</p>
	<p>Enter the temperature set-point,</p>
	<p>confirm with OK and go on to enter the fan speed set-point valid for the time after the timer has expired</p>
	<p>The current fan speed set-point is shown</p>
	<p>Enter the fan speed in steps of 10 % - 0 % and 40 % up to 100 %</p>
	<p>and confirm with OK.</p>
	<p>The timer function "Delayed On" is activated</p>
<p>2x </p>	<p>Back to Normal display.</p>

#### Normal display during timer operation with timer function "Delayed On"

	<p>The Timer run-time until turning on the heating is running. Timer function "Delayed On". The heating is off, temperature approximates ambient temperature.</p>
---	---

#### Normal display after the timer has expired:

	<p>The timer has expired. The time function is off. The heating is active to equilibrate the temperature set-point. The fan operates with the selected fan speed.</p>
---	---





## 8.4.2 Changing the settings

After the timer expired, the timer function „Delayed On“ deactivates, therefore turning the function off is not required.

As long as the timer is still running, the timer function settings can be subsequently modified in this menu.

To terminate the timer function, all time values (days, hours, minutes) must be set to zero in the according menu.

### Changing or terminating the timer function when the timer is running:

 <b>2 x</b> 	<p>From Normal display during timer operation</p> <p>with the arrow-down button to the <b>Timer function “Delayed On”</b> menu. (with connected USB device: press the arrow-down button 3 times)</p>
	<p>Timer function “Delayed On”, the timer is running. The fan operates with the selected fan speed.</p>
	<p>Confirm the timer function “Delayed On” with OK</p>
<p>see chap. 8.4.1</p>	<p>Modify the time values or set all time values to zero to terminate the timer function</p>
<b>2x</b> 	<p>Back to Normal display.</p>

## 8.5 Temperature programming example (BF, FED)

The chamber shall heat up to a temperature of 50 °C, maintain this temperature for three hours and then turn off.

Proceeding: Select timer function “Temperature dependent Delayed Off“ (chap. 8.3) and perform the following settings:

- Enter a timer run-time of 3 hours
- Enter the set point 50 °C
- Specify the fan speed after the timer expires

## 9. Ramp function

### 9.1 General information

You can program temperature ramps in order to extend heating up times. This may be necessary in some cases to prevent temperature stress in the material during the heating up phase. Temperature ramps should only be used if required. Using them may result in considerably slowing down the heating up times. When the ramp function is turned off, the chamber will heat up with its maximum heating capacity.

The entry means the nominal value gradient and limits the maximum temperature increase to this value. Due to the heat and evaporation energy assumed by the drying material, smaller temperature gradients may also result.

A ramp proceeds from a previously entered set-point to a new, higher one. The temperature must be equilibrated to the start set-point. Perform the setting in the following 3 steps:

1. Enter the temperature set-point as **start ramp set-point** and let the temperature equilibrate to this value
2. Define the temperature increase (**ramp gradient**) in °C/min or in °F/min in the setting menu "Ramp function"

You can select a gradient from „0.0“ up to „1.0“ or from „1“ up to „10“ according to the chamber type.

When setting the gradient to „0.0“ or „0“, ramp function is turned off. The chamber will then heat up with its maximum heating capacity.

The chamber will try to heat up according to the entered gradient, i.e. with a speed of xx degree per minute. A heating-up rate of 0.4 °C/min for the incubators BD and BF resp. 4 °C/min for the heating and drying ovens ED, FD and FED can be regarded as a realistic maximum.











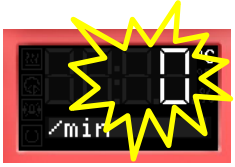

3. Enter the **target ramp set-point** in the "ramp function" setting menu.

As soon as the entries have been adopted, the ramp function is activated. The chamber heats up with the entered gradient, if the set ramp target value lies above the actual temperature value.

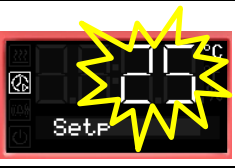
During ramp operation the **effective ramp set-point** continually rises in accordance to the entered gradient from the previously entered set-point to the new one. The actual value follows this continually changing effective ramp set-point. As soon as the ramp target value is reached, this temperature is maintained constant.

The actual temperature value, the selected gradient, and the target value are shown in Normal display. The effective ramp set-point can be seen through the temperature set-point function.











## 9.2 Setting and displaying the ramp function

<p>without fan <b>3x</b> </p> <p>with fan <b>4x</b> </p>	<p>From Normal display</p> <p>with the arrow-up button to the <b>Ramp function</b> menu.</p>
	Ramp function (not programmed)
	Press OK to enter the <b>gradient</b> in degree per minute.
	The gradient flashes.
	Enter the gradient (0 up to 9)
	confirm with OK and go on to enter the <b>target ramp set-point</b>
	The target ramp set-point value flashes.
	Enter the target ramp set-point
	and confirm with OK.
	Selected ramp with gradient 1 and target ramp set-point 40 °C (example)
	Back to Normal display.
	Normal display showing the actual temperature, the gradient and the target ramp set-point (example: 40 °C)

### Temperature course with ramp function















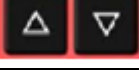

### 9.3 Displaying the effective ramp set-point and changing the target ramp set-point

 	<p>From Normal display showing the actual temperature (example: 27 °C), the gradient (example: 1) and the target ramp set-point (example: 40 °C)</p> <p>to the display of the effective ramp set-point</p>
	<p>The effective ramp set-point is displayed</p>
	<p>Press OK to set the target ramp set-point</p>
	<p>The target ramp set-point value flashes.</p>
	<p>Enter the target ramp set-point</p>
	<p>and confirm with OK.</p>
	<p>The effective ramp set-point is displayed</p>
<p>2x</p> 	<p>Back to Normal display.</p>
	<p>Normal display showing the actual temperature, the gradient and the modified target ramp set-point (example: 50 °C)</p>

## 9.4 Turning off the ramp function

To turn off the ramp function, the gradient must be set to zero in the according menu. The set-point can be entered as desired.

without fan <b>3x</b>  with fan <b>4x</b> 	From Normal display  with the arrow-up button to the <b>Ramp function</b> menu
	Ramp function with programmed gradient and target ramp set-point
	Press OK to enter the gradient in degree per minute.
	The gradient flashes.
	Enter the gradient zero (turning off the ramp function)
	confirm with OK and go on to the ramp target value
	The target ramp set-point value flashes.
	Enter the target ramp set-point
	and confirm with OK.
	Ramp function (not programmed)
	Back to Normal display.
	Normal display showing the actual temperature, the gradient and the target ramp set-point (example: 40 °C)
<b>2x</b> 	Back to Normal display.

Instead of turning off the ramp function (gradient = 0), you can also modify the settings of the gradient and target ramp set-point in this menu.

## 10. Data recording via USB interface



The USB interface located in the triangular instrument panel serves to read out the measured values, which are put out in real time. Following data is recorded: Timer, actual temperature value, temperature set-point, Object temperature sensor (chambers with option Object temperature display), Fan (chambers with fan), air flap position, safety controller, analog output (option), heating regulation ratio.

	Connect only USB sticks to the USB interface.
---	---

Data are stored directly on the USB stick. They are issued in the selected language as a spreadsheet with the file extension “.csv” and can be further processed in the desired program.

### 10.1 Starting data recording





Connect the USB stick to the interface located in the triangular instrument panel.





	From Normal display with the arrow-down button to the <b>USB</b> menu
	Current state of data recording: stopped
	Confirm with OK.

**Chambers without the real time clock option** do not save date and time after shut-down. To make sure that recorded data is provided with the correct date and time, with these chambers it is required to enter date and time first :

	The current date is displayed. For setting, proceed as described in chap. 6.4.
---	---

After entry of the minute and confirmation with OK, further setting in the USB menu continues.

	The data recording interval flashes.
	Enter the interval in minutes
	and confirm with OK.
	The current state of data recording (stopped) flashes.
	Change to start data recording.

	The current state of data recording (started) flashes
	Confirm with OK.
	Data recording is running.
	Back to Normal display.

Data recording continues also during stand-by mode of the chamber. Disconnecting the power supply interrupts data recording, which continues after the power returns. To terminate data recording, stop it via the menu (chap. 10.2).

## 10.2 Terminating data recording

	From Normal display with the arrow-down button to the <b>USB</b> menu
	Current state of data recording: running
	Confirm with OK.
	The current state of data recording (running) flashes
	Change to stop data recording
	The current state of data recording (stopped) flashes
	Confirm with OK.
	Data recording is stopped.
	Back to Normal display.











## 11. Network configuration for chambers with Ethernet interface

The settings of this submenu are used for networking chambers with an Ethernet interface, e.g. to connect them with BINDER's communication software APT-COM™ 3 DataControlSystem (option, chap. 12.1).



This menu subsequently offers the following settings:



- Display of the chamber's **MAC address** (no setting)
- Switching on and off the **DHCP state**
- Entering the **IP address**
- Entering the **subnet** mask number
- Entering the **gateway** number

without fan <b>5x</b>  with fan <b>6x</b> 	From Normal display with the arrow-up button to the user menu
	Confirm with OK.
	Enter the password (factory setting: 00 00) and confirm each entry with OK.
<b>5 x</b> 	with the arrow-up button to the <b>Ethernet</b> menu.
	Confirm with OK.
	The first digits of the <b>MAC address</b> are shown.
	Continue with OK. The middle digits of the <b>MAC address</b> are shown.
	Continue with OK. The last digits of the <b>MAC address</b> are shown.



Displaying the chamber's MAC address serves to identify the chamber in the Ethernet network.

Example: **00-0F-67-0F-42-40**





00-0F	67-0F	42-40
		

	Continue with OK to <b>switching on and off the DHCP state</b>
	The current DHCP state is displayed (on). The setting flashes.
	Select the setting with the arrow buttons.





There are the following options:





<p>DHCP switched on:</p> 	<p>DHCP switched off:</p> 
--	---

To configure the network settings, the DHCP state must be switched off. Otherwise, the DHCP-server would assign the network configuration..





	Confirm with OK and go on to enter the <b>IP address</b> .
	The first digits of the current IP address are shown. The setting flashes.
	Enter the desired values with the arrow buttons
	and confirm with OK. The next digits of the IP address are shown. Enter the desired values accordingly.





Example value: 0.0.0.0

0	0	0	0
			





	Confirm with OK and go on to enter the <b>subnet mask</b> .
	The first digits of the current subnet mask are shown. The setting flashes.
	Enter the desired values with the arrow buttons
	and confirm with OK. The next digits of the subnet mask are shown. Enter the desired values accordingly.



Example value: 255.255.255.0

<p style="text-align: center;">255</p> 	<p style="text-align: center;">255</p> 	<p style="text-align: center;">255</p> 	<p style="text-align: center;">0</p> 
--	--	---	--

	Confirm with OK and go on to enter the <b>gateway</b> .
	The first digits of the current gateway are shown. The setting flashes.
	Enter the desired values with the arrow buttons
	and confirm with OK. The next digits of the gateway are shown. Enter the desired values accordingly.

Example value: 0.0.0.0

<p style="text-align: center;">0</p> 	<p style="text-align: center;">0</p> 	<p style="text-align: center;">0</p> 	<p style="text-align: center;">0</p> 
--	--	---	--

	Confirm with OK.
<p style="text-align: center;"><b>2x</b></p> 	Back to Normal display.

## 12. Options

### 12.1 Communication software APT-COM™ 3 DataControlSystem (option)

The chamber is regularly (FED) or optionally equipped with an Ethernet interface on the chamber rear that can connect the BINDER communication software APT-COM™ 3 DataControlSystem. The actual temperature value is given at adjustable intervals. Programming can be performed graphically via PC. Up to 30 chambers can be cross-linked. The MAC Address is indicated in the **Ethernet** menu (chap. 11). For further information, please refer to the operating manual of the BINDER communication software APT-COM™ 3.

To establish a connection via the chamber's Ethernet interface, the chamber must be turned off.

### 12.2 Data logger kits (option)

BINDER Data Logger Kits offer an independent long-term measuring system for temperature. They are equipped with a keyboard and a large LCD display, alarm functions and a real-time function. Measurement data are recorded in the Data Logger and can be read out after the measurement via the RS232 interface of the Data Logger. It offers a programmable measuring interval and permits storing up to 64000 measuring values. Reading out is done with the Data Logger evaluation software. You can give out a combined alarm and status protocol directly to a serial printer.

**For BD/BF: Data Logger Kit T 220:** Temperature range  $-90\text{ °C} / -130\text{ °F}$  up to  $+220\text{ °C} / 428\text{ °F}$

**For ED/FD/FED: Data Logger Kit T 350:** Temperature range  $0\text{ °C} / 32\text{ °F}$  up to  $+350\text{ °C} / 662\text{ °F}$



For detailed information on installation and operation of the BINDER Data Logger, please refer to the mounting instructions Art. No. 7001-0204 and to the original user manual of the manufacturer, supplied with the data logger.

### 12.3 Object temperature display with additional Pt100 temperature sensor (option)

With this option an additional flexible temperature sensor Pt100 measures the chamber temperature or the temperature of the charging material which is shown on the controller. The sensor-top protective tube of the flexible Pt100 can be immersed into liquid substances.

The object temperature display enables the determination of the actual temperature of the charging material during the whole process. The object temperature is displayed in the controller in Normal Display.



Chamber with option object temperature display:  
Actual temperature value and actual object temperature value

#### Technical data of the Pt100 sensor:

- Three-wire technique
- Class B (DIN EN 60751)
- Temperature range up to  $320\text{ °C} / 608\text{ °F}$
- Stainless steel protective tube 45 mm length, material no. 1.4501

## 12.4 Analog output for temperature (option)

With this option the chamber is equipped with an analog output 4-20 mA for temperature. This output permits transmitting data to external data registration systems or devices.

The connection is carried out as a DIN socket at the rear of the chamber as follows:



### ANALOG OUTPUT 4-20 mA DC

PIN 1: Temperature –

PIN 2: Temperature +

#### Temperature range:

BD, BF: 0 °C / 32 °F to +100 °C / 212 °F

ED, FD, FED: 0 °C / 32 °F to +300 °C / 572 °F

A suitable DIN plug is enclosed.

Figure 10: Pin allocation of DIN socket for option analog outputs

## 12.5 Water protected disconnectable internal socket (option BD, BF)



You can turn on or off the disconnectable water protected internal socket (CA3GD) for line voltage inside the chamber by the switch in the triangular instrument panel, independent of the incubator operating or not. Thus, devices operated inside the incubator can be started or stopped without any need to open the chamber doors.

The internal socket provides a protective conductor, therefore it is possible to connect appliances with protection class I.

The internal socket is splash proof.

IP system of protection 67 230 V 1N ~ 50-60 Hz. Charge max. 500 W



**Maximum permitted operating temperature with this option: 90 °C / 194 °F.**

	 <b>WARNING</b>
	<p><b>Exceeding of the permitted maximum temperature.</b></p> <p><b>Electrical hazard.</b></p> <p><b>Danger of death.</b></p> <p><b>Damage to the internal socket.</b></p> <ul style="list-style-type: none"> <li>⊘ Do NOT exceed the temperature set-point of 90 °C / 194 °F.</li> <li>➤ Set the safety controller class 3.1 to 90 °C / 194 °F.</li> </ul>

	<p>Heat emission of electrical devices connected inside the chamber may modify the temperature range.</p>
---	---

	<b>CAUTION</b>
	<p><b>Risk of short circuit.</b></p> <p><b>Damage to the chamber.</b></p> <ul style="list-style-type: none"> <li>➤ Use the delivered plug only (IP protection type 66). Plug-in the plug and turn it to secure.</li> <li>➤ If the socket is not used, close the lift-up lid and turn it for securing.</li> </ul>

Controller shutdown by the standby button has no effect on the internal socket.

	 <b>WARNING</b>
	<p><b>Internal socket switched on even though controller is shut down.</b>  <b>Electrical hazard.</b></p> <p>➤ Turn off the internal socket separately, when not in use, by the switch in the triangular instrument panel</p>

## 12.6 HEPA fresh air filter (option for FD, FED)

With this option, the introduced fresh air is cleaned by means of a high efficiency submicron particulate air filter type HEPA class H 14 (acc. to DIN EN 1822:2009). Replace the filter insert, if necessary, by removing the metal cover of the filter at the left side of the chamber (Art. No. 6014-0003).

## 12.7 Mostly gas-tight version (option for BF, FD, FED)

With this option the chamber is additionally sealed, so the loss when introducing gases is decreased. The chamber is not completely gas-tight, so it is impossible to establish overpressure. The sealing diminishes the release of vapors via the housing that may be set free from the charging material when heated. Carrying-off via the regular evacuation duct, e.g. into a waste air installation, is likely to further reduce emissions.

	<p>The chamber is not completely gas-tight. Gases from inside the chamber can escape into the surrounding atmosphere.</p> <p>Observe the occupational exposure limit OEL for the released substance set by the national authorities (formerly maximum permitted workplace concentration). Respect the relevant regulations.</p> <p>Any harmful gas that might escape has to be led out via good room ventilation or a suitable exhaust system. Place the chamber, if necessary, below a gas vent.</p>
---	---

The air flap does not close the exhaust duct completely. The delivered plug serves to avoid emerging of vapors or loss of introduced inert gas, if any, via the exhaust duct. Due to special demands of heat resistance, use the delivered plug only.

	<b>CAUTION</b>
	<p><b>Use of inappropriate plug.</b>  <b>Danger of inflammation.</b></p> <p>➤ To close the exhaust duct use the delivered plug only.</p>

For drying purpose, please remove the plug in order to permit dissipation of the generated vapor, which would lead to condensation in the inner chamber.

## 12.8 Inert gas connection with mostly gas-tight version (option for BF, FD, FED)

With this option the chamber is additionally sealed, so the loss when introducing inert gases is decreased. For details on the mostly gas-tight version please refer to chap. 8.4.

The chamber is equipped with two ports for inert gas (nitrogen or noble gases).

The ports are located **on the top panel in the middle** and **on the chamber rear at the bottom right**. Each of these ports can be used as inlet or outlet, depending on the nature of the inert gas:

- lighter gas (nitrogen, helium): lower port as inlet
- heavy gas (e.g. argon): upper port as inlet

This distinction is important when operating with a reduced fan speed.

## Connection

Observe the legal requirements and relevant standards and regulations for the safe handling of gas cylinders and inert gases.

	<p>General information for safe handling of gas cylinders:</p> <ul style="list-style-type: none"> <li>• Store and use gas cylinders only in well ventilated areas.</li> <li>• Open the gas cylinder valve slowly to avoid pressure surges</li> <li>• Secure gas cylinders during storage and use against falling (chaining).</li> <li>• Transport gas cylinders with a cylinder cart, do not carry, roll, or throw them</li> <li>• Always close the valve even with apparently empty cylinders; screw on the cap when not in use. Return gas cylinders with the valve closed</li> <li>• Do not open gas cylinders by force. Mark them when damaged</li> <li>• Observe relevant regulations for dealing with gas cylinders.</li> </ul>
---	---



Connect a flexible gas tube to the gas hose connection adapter (diameter 10mm), which is used for gas inlet, and secure it with hose clamps (hose and hose clamps are not enclosed). There is a constant gas flow after establishing the connection.

	<p>After connecting the gas cylinder, check all gas connections for leaks (e.g. with leak spray or diluted soap solution).</p>
---	--

Use a pressure reducer and make sure to avoid any excessive outlet pressure when connecting the gas hose to the chamber.

	<p>The chamber is not entirely gas-tight. Inert gases from inside the chamber can escape into the surrounding atmosphere.</p>
---	---

Inert gases in high concentrations is hazardous to health. They are colorless and almost odorless and therefore practically imperceptible. Inhalation of inert gases can cause drowsiness up to respiratory arrest. When the O<sub>2</sub> content of the air decreases below 18%, there is risk of death from lack of oxygen. Any gas that might escape has to be led out via good room ventilation or a suitable exhaust system.

	 <b>WARNING</b>
	<p><b>High concentration of inert gas.</b> <b>Risk of death by suffocation.</b></p> <ul style="list-style-type: none"> <li>⊘ Do NOT set up chambers in non-ventilated recesses.</li> <li>➤ Ensure technical ventilation measures.</li> <li>➤ Respect the relevant regulations for handling these gases.</li> </ul>

	<p>Inert gases, which are heavier than air, may accumulate in low-lying areas of the installation site.</p>
---	---

The "Mostly gas-tight version" reduces the loss of gas.

### Setting (sample values):

If you want to flush the chamber with an air exchange rate of 1 per hour, set the flow rate on the pressure reducer according to the interior volume.

Chamber with 56 l internal volume: The flow rate corresponding to 56 l / h is 0.9 l / min.

Chamber with 115 l internal volume: The flow rate corresponding to 115 l / h is 1.9 l / min.

Chamber with 260 l internal volume: The flow rate corresponding to 260 l / h is 4.3 l / min.



The air flap does not close the exhaust duct completely. The delivered plug serves to avoid loss of introduced inert gas via the exhaust duct. Due to special demands of heat resistance, use the delivered plug only.

	<b>CAUTION</b>
	<p><b>Use of inappropriate plug.</b>  <b>Danger of inflammation.</b></p> <ul style="list-style-type: none"> <li>➤ To close the exhaust duct use the delivered plug only.</li> </ul>

For drying purpose, please remove the plug in order to permit dissipation of the generated vapor, which would lead to condensation in the inner chamber.

## 13. Maintenance, cleaning, and service

### 13.1 Maintenance intervals, service

 	<b>DANGER</b>
	<p><b>Electrical hazard.</b>  <b>Danger of death.</b></p> <ul style="list-style-type: none"> <li>Ø The chamber must NOT become wet during operation or maintenance work.</li> <li>Ø Do NOT remove the rear panel of the chamber.</li> <li>➤ Disconnect the chamber before conducting maintenance work. Disconnect the power plug.</li> <li>➤ Ensure all maintenance work is conducted by licensed electricians or experts authorized by BINDER.</li> </ul>

Ensure regular maintenance work is performed at least once a year.

	The warranty becomes void if maintenance work is conducted by non-authorized personnel..
---	--

	Replace the door gasket only when cold. Otherwise, the door gasket may become damaged.
---	--

We recommend taking out a maintenance agreement. Please consult BINDER Service.





BINDER telephone hotline:	+49 (0) 7462 2005 555
BINDER fax hotline:	+49 (0) 7462 2005 93555
BINDER e-mail hotline:	service@binder-world.com
BINDER service hotline USA:	+1 866 885 9794 or +1 631 224 4340 x3 (toll-free in the USA)
BINDER service hotline Asia Pacific:	+852 390 705 04 or +852 390 705 03
BINDER service hotline Russia and CIS	+7 495 988 15 16
BINDER Internet website	<a href="http://www.binder-world.com">http://www.binder-world.com</a>
BINDER address	BINDER GmbH, post office box 102, D-78502 Tuttlingen

International customers, please contact your local BINDER distributor.



## 13.2 Cleaning and decontamination

Clean the chamber after each use to avoid potential corrosion damage by ingredients of the test material.

  	 <b>DANGER</b>
	<p><b>Electrical hazard.</b> <b>Danger of death.</b></p> <ul style="list-style-type: none"> <li>∅ Do NOT spill water or cleaning agents over the inner and outer surfaces.</li> <li>➤ Disconnect the chamber before cleaning. Disconnect the power plug.</li> <li>➤ Completely dry the chamber before turning it on again.</li> </ul>

### 13.2.1 Cleaning

Disconnect the chamber from the power supply before cleaning. Disconnect the power plug.

	The interior of the chamber must be kept clean. Thoroughly remove any residues of the charging material
---	---

Wipe the surfaces with a moistened towel. In addition, you can use the following cleaning agents:

Exterior surfaces inner chamber racks door gaskets	Standard commercial cleaning detergents free from acid or halides. Alcohol-based solutions. We recommend using the neutral cleaning agent Art. No. 1002-0016.
Instrument panel	Standard commercial cleaning detergents free from acid or halides. We recommend using the neutral cleaning agent Art. No. 1002-0016.
Zinc coated hinge parts rear chamber wall	Standard commercial cleaning detergents free from acid or halides. Do NOT use a neutral cleaning agent on zinc coated surfaces.

Do not use cleaning agents that may cause a hazard due to reaction with components of the device or the charging material. If there is doubt regarding the suitability of cleaning products, please contact BINDER service.

	<p>We recommend using the neutral cleaning agent Art. No. 1002-0016 for a thorough cleaning.</p> <p>Any corrosive damage that may arise following use of other cleaning agents is excluded from liability by BINDER GmbH.</p> <p>Any corrosive damage caused by a lack of cleaning, is excluded from liability by BINDER GmbH.</p>
---	--

	<b>CAUTION</b>
	<p><b>Danger of corrosion.</b> <b>Damage to the chamber.</b></p> <ul style="list-style-type: none"> <li>∅ Do NOT use acidic or chlorine cleaning detergents.</li> <li>∅ Do NOT use a neutral cleaning agent on other kind of surfaces e.g., the zinc coated hinge parts or the rear chamber wall.</li> </ul>

	<p>For surface protection, perform cleaning as quickly as possible.</p> <p>After cleaning completely remove cleaning agents from the surfaces with a moistened towel. Let the chamber dry.</p>
---	--



	Soapsuds may contain chlorides and must therefore NOT be used for cleaning.
---	---

	With every decontamination method, always use adequate personal safety controls.
---	--

Following cleaning, leave the chamber door open or remove the access port plugs.

	The neutral cleaning agent may cause health problems in contact with skin and if ingested. Follow the operating instructions and safety hints labeled on the bottle of the neutral cleaning agent.
---	--

Recommended precautions: To protect the eyes use sealed protective goggles. Suitable protective gloves with full contact: butyl or nitrile rubber, penetration time >480 minutes.

	 <b>CAUTION</b>
	<p><b>Contact with skin, ingestion.</b>  <b>Skin and eye damage due to chemical burns.</b></p> <ul style="list-style-type: none"> <li>∅ Do not ingest. Keep away from food and beverages.</li> <li>∅ Do NOT empty into drains.</li> <li>➤ Wear protective gloves and goggles.</li> <li>➤ Avoid skin contact.</li> </ul>

### 13.2.2 Decontamination

The operator must ensure that proper decontamination is performed in case a contamination of the chamber by hazardous substances has occurred.

Disconnect the chamber from the power supply prior to decontamination. Pull the power plug.

Do not use decontamination agents that may cause a hazard due to reaction with components of the device or the charging material. If there is doubt regarding the suitability of cleaning products, please contact BINDER service.

You can use the following disinfectants:

Inner chamber	Standard commercial surface disinfectants free from acid or halides. Alcohol-based solutions. We recommend using the disinfectant spray Art. No. 1002-0022.
---------------	---

	For chemical disinfection, we recommend using the disinfectant spray Art. No. 1002-0022. Any corrosive damage that may arise following use of other disinfectants is excluded from liability by BINDER GmbH.
---	--

	With every decontamination method, always use adequate personal safety controls.
---	--

In case of impurity of the interior with biological or chemical hazardous material, there are three possible procedures depending on the type of contamination and of the charging material.

1. The drying and heating ovens ED, FD and FED can be hot air sterilized at 190 °C / 374 °F for at least 30 minutes. All inflammable goods must be removed from the interior before. With the incubators BD and BF it is possible to perform a hot-air disinfection at 100 °C / 212 °F.





2. Spray the inner chamber with an appropriate disinfectant.

Before start-up, the chamber must be absolute dry and ventilated, because explosive gases may form during the decontamination process.

3. BD, ED: If necessary, have strongly contaminated inner chamber parts removed by an engineer for cleaning, or have them exchanged. Sterilize the inner chamber parts in a sterilizer or autoclave. You can also remove and sterilize the racks.

	<p>In case of eye contact, the disinfectant spray may cause eye damage due to chemical burns. Follow the operating instructions and safety hints labeled on the bottle of the disinfectant spray.</p>
---	---

Recommended precautions: To protect the eyes use sealed protective goggles.

	<table border="1"> <tr> <td data-bbox="911 819 986 891">  </td> <td data-bbox="1002 824 1169 869"> <p><b>CAUTION</b></p> </td> </tr> <tr> <td colspan="2"> <p><b>Eye contact.</b>  <b>Eye damage due to chemical burns.</b></p> <ul style="list-style-type: none"> <li>⊘ Do NOT empty into drains.</li> <li>➤ Wear protective goggles.</li> </ul> </td> </tr> </table>		<p><b>CAUTION</b></p>	<p><b>Eye contact.</b>  <b>Eye damage due to chemical burns.</b></p> <ul style="list-style-type: none"> <li>⊘ Do NOT empty into drains.</li> <li>➤ Wear protective goggles.</li> </ul>	
	<p><b>CAUTION</b></p>				
<p><b>Eye contact.</b>  <b>Eye damage due to chemical burns.</b></p> <ul style="list-style-type: none"> <li>⊘ Do NOT empty into drains.</li> <li>➤ Wear protective goggles.</li> </ul>					

	<p>After using the disinfectant spray, allow the chamber to dry thoroughly, and aerate it sufficiently.</p>
---	---

### 13.3 Sending the chamber back to BINDER GmbH

If you return a BINDER product to us for repair or any other reason, we will only accept the product upon presentation of an **authorization number** (RMA number) that has previously been issued to you. An authorization number will be issued after receiving your complaint either in writing or by telephone **prior** to your sending the BINDER product back to us. The authorization number will be issued following receipt of the information below:

- BINDER product type and serial number
- Date of purchase
- Name and address of the dealer from which you bought the BINDER product
- Exact description of the defect or fault
- Complete address, contact person and availability of that person
- Exact location of the BINDER product in your facility
- A contamination clearance certificate (chap. 19) must be faxed in advance

The authorization number must be applied to the packaging in such a way that it can be easily recognized or be recorded clearly in the delivery documents.

	<p>For safety reasons we cannot accept a chamber delivery if it does not carry an authorization number.</p>
---	---

**Return address:** BINDER GmbH, Abteilung Service  
 Gänsäcker 16, 78502 Tuttlingen, Germany

## 14. Disposal



### 14.1 Disposal of the transport packing

Packing element	Material	Disposal
Straps to fix packing on pallet	Plastic	Plastic recycling
Wooden transport box (option) with metal screws	Non-wood (compressed match-wood, IPPC standard)	Wood recycling
	Metal	Metal recycling
Pallet (from size 115 on)	Solid wood (IPPC standard)	Wood recycling
Transport box with metal clamps	Cardboard	Paper recycling
	Metal	Metal recycling
Top cover (size 720)	Cardboard	Paper recycling
Edge protection	Styropor® or PE foam	Plastic recycling
Protection of doors and racks	PE foam	Plastic recycling
Bag for operating manual	PE foil	Plastic recycling
Insulating air cushion foil (packing of optional accessories)	PE foil	Plastic recycling

If recycling is not possible, all packing parts can also be disposed of with normal waste.

### 14.2 Decommissioning

- ED, FD, FED size 720: Turn off the chambers at the main power switch (chap. 2.3).
- Disconnect the chamber from the power supply (pull the power plug).
- With option inert gas connection (chap. 12.8): Close the inert gas supply and remove the gas connection.

	 <b>WARNING</b>
	<p><b>High concentration of inert gas.</b> <b>Risk of death by suffocation.</b></p> <ul style="list-style-type: none"> <li>➤ Respect the relevant regulations for handling these gases.</li> <li>➤ When decommissioning the chamber, turn off the inert gas supply.</li> </ul>

- Temporal decommissioning: See indications for appropriate storage, chap. 3.3.
- Final decommissioning: Dispose of the chamber as described in chap. 14.3 to 14.5.

### 14.3 Disposal of the chamber in the Federal Republic of Germany

According to Annex I of Directive 2012/19/EU of the European Parliament and of the Council on waste electrical and electronic equipment (WEEE), BINDER devices are classified as “monitoring and control instruments” (category 9) only intended for professional use“. They must not be disposed of at public collecting points.

The chambers bear the symbol for the marking of electrical and electronic equipment manufactured / placed on the market in the EC after 13 August 2005 and be disposed of in separate collection according to Directive 2012/19/EU on waste electrical and electronic equipment (WEEE) and German national law for electrical and electronic equipment (Elektro- und Elektronikgerätegesetz, ElektroG). WEEE marking: crossed-out wheeled bin with solid bar under. A significant part of the materials must be recycled in order to protect the environment.

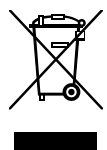



At the end of the device's service life, have the device disposed of according to the German national law for electrical and electronic equipment (Elektro- und Elektronikgerätegesetz, ElektroG from 20 October 2015, BGBl. I p. 1739) or contact BINDER service who will organize taking back and disposal of the chamber according to the German national law for electrical and electronic equipment (Elektro- und Elektronikgerätegesetz, ElektroG from 20 October 2015, BGBl. I p. 1739).

	<b>CAUTION</b>
	<p><b>Violation against existing law.</b></p> <ul style="list-style-type: none"> <li>⊘ Do NOT dispose of BINDER devices at public collecting points.</li> <li>➤ Have the device disposed of professionally at a recycling company which is certified according to the German national law for electrical and electronic equipment (Elektro- und Elektronikgerätegesetz, ElektroG from 20 October 2015, BGBl. I p. 1739).</li> <li style="text-align: center;"><i>or</i></li> <li>➤ Instruct BINDER Service to dispose of the device. The general terms of payment and delivery of BINDER GmbH apply, which were valid at the time of purchasing the chamber.</li> </ul>

Certified companies disassemble waste BINDER equipment in primary substances for recycling according to Directive 2012/19/EU. In order to eliminate any health hazards to the employees of the recycling companies, the devices must be free from toxic, infectious or radioactive substances.

	<p>Prior to handing the chamber over to a recycling company, it is the user's responsibility that it is free from toxic, infectious or radioactive substances.</p> <ul style="list-style-type: none"> <li>• Prior to disposal, clean all introduced or residual toxic substances from the chamber.</li> <li>• Prior to disposal, disinfect the chamber from all sources of infection. Be aware of the fact that sources of infection may also be located outside the inner chamber.</li> <li>• If you cannot safely remove all toxic substances and sources of infection from the chamber, dispose of it as "special" waste according to national law.</li> <li>• Fill out the contamination clearance certificate (chap. 19) and enclose it with the chamber.</li> </ul>
---	---

	 <b>WARNING</b>
	<p><b>Contamination of the device with toxic, infectious or radioactive substances.</b></p> <p><b>Danger of intoxication.</b></p> <p><b>Danger of infection.</b></p> <ul style="list-style-type: none"> <li>⊘ NEVER take a chamber contaminated with toxic substances or sources of infection for recycling according to Directive 2012/19/EU.</li> <li>➤ Prior to disposal, remove all toxic substances and sources of infection from the chamber.</li> <li>➤ Dispose of a chamber from which all toxic substances or sources of infection cannot be safely removed as special waste according to national law.</li> </ul>

#### 14.4 Disposal of the chamber in the member states of the EU except for the Federal Republic of Germany

According to Annex I of Directive 2012/19/EU of the European Parliament and of the Council on waste electrical and electronic equipment (WEEE), BINDER devices are classified as "monitoring and control instruments" (category 9) only intended for professional use". They must not be disposed of at public collecting points.

The chambers bear the symbol for the marking of electrical and electronic equipment manufactured / placed on the market in the EC after 13 August 2005 and be disposed of in separate collection according to the Directive 2012/19/EU on waste electrical and electronic equipment (WEEE). WEEE marking: crossed-out wheeled bin with solid bar under.

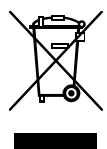



At the end of the device's service life, notify the distributor who sold you the device, who will take back and dispose of the chamber according to the Directive 2012/19/EU on waste electrical and electronic equipment (WEEE).



	<b>CAUTION</b>
	<p><b>Violation against existing law.</b></p> <ul style="list-style-type: none"> <li>⊘ Do NOT dispose of BINDER devices at public collecting points.</li> <li>➤ Have the device disposed of professionally at a recycling company which is certified according to conversion of the Directive 2012/19/EU into national law. <i>or</i></li> <li>➤ Instruct the distributor who sold you the device to dispose of it. The agreements apply that were reached with the distributor when purchasing the chamber (e.g. his general terms of payment and delivery).</li> <li>➤ If your distributor is not able to take back and dispose of the chamber, please contact BINDER service.</li> </ul>

Certified companies disassemble waste BINDER equipment in primary substances for recycling according to Directive 2012/19/EU. In order to exclude any health hazard for the employees of the recycling companies, the devices must be free from toxic, infectious or radioactive substances.

	<p>Prior to handing the chamber over to a recycling company, it is the user's responsibility that it is free from toxic, infectious or radioactive substances.</p> <ul style="list-style-type: none"> <li>• Prior to disposal, clean all introduced or residual toxic substances from the chamber.</li> <li>• Prior to disposal, disinfect the chamber from all sources of infection. Be aware of the fact that sources of infection may also be located outside the inner chamber.</li> <li>• If you cannot safely remove all sources of infection and toxic substances from the chamber, dispose of it as "special" waste according to national law.</li> <li>• Fill out the contamination clearance certificate (chap. 19) and enclose it with the chamber.</li> </ul>
---	---

 	 <b>WARNING</b>
	<p><b>Contamination of the device with toxic, infectious or radioactive substances.</b>  <b>Danger of intoxication.</b>  <b>Danger of infection.</b></p> <ul style="list-style-type: none"> <li>⊘ NEVER take a chamber contaminated with toxic substances or sources of infection for recycling according to Directive 2012/19/EU.</li> <li>➤ Prior to disposal, remove all toxic substances and sources of infection from the chamber.</li> <li>➤ Dispose of a chamber from which all toxic substances or sources of infection cannot be safely removed as "special" waste according to national law.</li> </ul>

#### 14.5 Disposal of the chamber in non-member states of the EU

 	<b>CAUTION</b>
	<p><b>Alteration of the environment.</b></p> <ul style="list-style-type: none"> <li>➤ For final decommissioning and disposal of the chamber, please contact BINDER Service.</li> <li>➤ Follow the statutory regulations for appropriate, environmentally friendly disposal.</li> </ul>

## 15. Troubleshooting

Fault description	Possible cause	Required measures
<b>Temperature</b>		
Set-point temperature is not reached after specified time.	Chamber door not properly closed.	Completely close chamber door.
	Door gasket defective.	Replace door gasket,
	Controller not adjusted.	Calibrate and adjust controller.
	Wrong voltage.	Check the power supply for correct voltage (chap. 4.2).
<i>BF, FD, FED</i> : The fan doesn't turn or turns too slowly.	<i>BF, FED</i> : Fan speed set too low	<i>BF, FED</i> : Set fan speed to 100%
	Fan defective.	Contact BINDER service.
Chamber heating permanently, set-point not held.	Controller defective.	Contact BINDER service.
	Pt 100 sensor defective.	
	Semiconductor relay defective	Calibrate and adjust controller.
	Controller not adjusted.	
Chamber doesn't heat up. Heating icon is displayed.	Heating element defective.	Contact BINDER service.
	Semiconductor relay defective.	
Chamber doesn't heat up. No heating icon in the display. Controller display working.	Timer run off.	Re-program the timer or turn it off.
	Semiconductor relay defective.	Contact BINDER service.
	Controller defective.	
Chamber without function, the standby icon is displayed.	Chamber in standby mode.	Press down the standby button until the display lights up.
<i>BD, BF</i> : Alarm message "!TProt" is displayed	Safety device class 3.1 has responded.	Check the settings of the temperature set-point and of the safety device class 3.1 (chap. 7.3).
<i>ED, FD, FED</i> : Chamber without function. Alarm message "!TLim" is displayed	Safety device class 2 has turned off the chamber.	Let cool down the chamber. Check the settings of the temperature set-point and of the safety device class 2 (chap. 7.3). If appropriate, select suitable limit value.
	Safety device class 2 defective.	Contact BINDER service.
Chamber without any function.	No power supply.	Check connection to power supply.
	Overtemperature protective device class 1 has turned off the chamber.	Disconnect the chamber from the power supply for at least 10 seconds and let it cool down. If the device responds again, contact BINDER service
	Controller defective.	Contact BINDER service.
Deviations from the indicated heating-up times.	Chamber fully loaded.	Load the chamber less or consider longer heating-up times.
<b>Controller</b>		
Message „1999" in the controller display	Sensor rupture between sensor and controller.	Contact BINDER service.



Only qualified service personnel authorized by BINDER must perform repair. Repaired chambers must comply with the BINDER quality standards.



## 16. Technical description

### 16.1 Factory calibration and adjustment

This chamber was calibrated and adjusted in the factory. Calibration and adjustment were performed using standardized test instructions, according to the QM DIN EN ISO 9001 system applied by BINDER (certified since December 1996 by TÜV CERT). All test equipment used is subject to the administration of measurement and test equipment that is also constituent part of the BINDER QM DIN EN ISO 9001 systems. They are controlled and calibrated to a DKD-Standard at regular intervals.

### 16.2 Definition of usable volume

The usable volume illustrated below is calculated as follows:

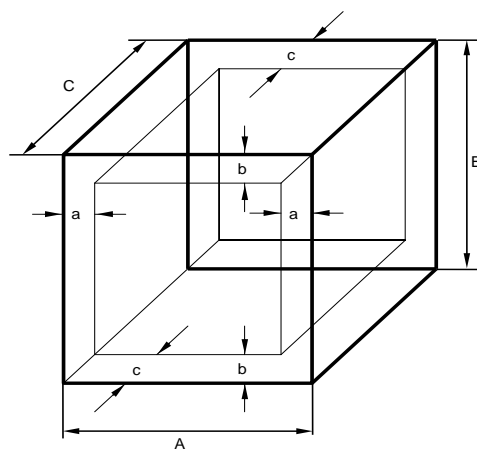

A, B, C = Internal dimensions (W, H, D)  
a, b, c = Wall clearances

$$a = 0.1 \times A$$

$$b = 0.1 \times B$$

$$c = 0.1 \times C$$

$$V_{\text{USE}} = (A - 2a) \times (B - 2b) \times (C - 2c)$$

Figure 11: Determination of the useable volume

**The technical data refers to the defined usable volume.**



Do NOT place samples outside this usable volume.  
Do NOT load this volume by more than half to enable sufficient airflow inside the chamber.  
Do NOT divide the usable volume into separate parts with large area samples.  
Do NOT place samples too close to each other in order to permit circulation between them and thus obtain a homogenous distribution of temperature.

### 16.3 Over current protection

**Single-phase devices** are protected by one (UL chambers) or two miniature fuses against over current, accessible from the outside. The miniature fuses are located at the rear of the chamber above the power cable connection. Each fuse holder is equipped with a fuse clip 5mm x 20 mm (cUL-Version 6,3x32 mm). A fuse may be replaced only with a substitute of the same ratings. Refer to the technical data of the respective device type.

**Two-phase devices** are equipped with a resettable miniature circuit breaker (combination element).

**Three-phase devices** are equipped with an internal miniature circuit breaker.



## 16.4 BD technical data

Chamber size		BD 56	BD 115	BD 260	BD 720	
<b>Exterior dimensions</b>						
Width, net	mm / inch	560 / 22.01	710 / 27.95	815 / 32.09	1165 / 45.87	
Height, gross (incl. feet)	mm / inch	625 / 24.60	735 / 28.94	965 / 37.99	1590 / 62.60	
Depth, net	mm / inch	565 / 22.24	605 / 23.82	760 / 29.92	816 / 32.13	
Depth, gross (incl. door handle, exhaust duct)	mm / inch	640 / 25.20	680 / 26.77	815 / 32.09	870 / 34.25	
Wall clearance rear (minimum)	mm / inch	160 / 6.30	160 / 6.30	160 / 6.30	160 / 6.30	
Wall clearance side (minimum)	mm / inch	100 / 3.94	100 / 3.94	100 / 3.94	100 / 3.94	
Exhaust duct, outer diameter	mm / inch	52 / 2.05	52 / 2.05	52 / 2.05	52 / 2.05	
<b>Doors</b>						
Number of doors		1	1	1	2	
Number of inner glass doors		1	1	1	2	
<b>Interior dimensions</b>						
Width	mm / inch	360 / 14.17	510 / 20.08	610 / 24.02	960 / 37.80	
Height	mm / inch	420 / 16.54	530 / 20.87	760 / 29.92	1280 / 50.39	
Depth	mm / inch	380 / 14.96	420 / 16.53	550 / 21.65	605 / 23.81	
Interior volume	l / cu.ft.	57 / 2.01	112 / 3.96	255 / 9.01	***	
Steam space volume	l / cu.ft.	63 / 2.22	127 / 4.49	279 / 9.85	***	
<b>Racks</b>						
Quantity of racks (regular)		2	2	2	2	
Quantity of racks (max.)		4	5	8	16	
Max. load per rack (standard rack)	Kg / lbs	30 / 66	30 / 66	40 / 88	45 / 99	
Max. load per rack (optional perforated shelf)	Kg / lbs	35 / 77	35 / 77	35 / 77	35 / 77	
Max. load per rack (optional heavy load rack)	Kg / lbs	50 / 110	70 / 154	80 / 176	70 / 154	
Permitted total load	Kg / lbs	70 / 154	150 / 330	270 / 595	315 / 694	
<b>Weight</b>						
Weight (empty)	Kg / lbs	38 / 84	54 / 119	85 / 187	170 / 375	
<b>Temperature data</b>						
Temperature range	from ... degrees above ambient	°C / °F	5 / 9	5 / 9	5 / 9	5 / 9
	up to	°C / °F	100 / 212	100 / 212	100 / 212	100 / 212
Temperature fluctuation at 37 °C / 98.6 °F		± K	0.2	0.1	0.2	0.1
Temperature uniformity (variation) at 37 °C / 98.6 °F		± K	0.4	0.4	0.4	0.7
Heating up time to 37 °C / 98.6 °F		minutes	45	55	65	70
Recovery time after door was opened for 30 sec at 37 °C / 98.6 °F		minutes	16	16	19	23
<b>Electrical data (model versions BD056-230V, BD115-230V, BD260-230V, BD720-230V)</b>						
System of protection acc. to EN 60529		IP	20	20	20	20
Nominal voltage (+/-10%)	at 50 Hz power frequency	V	230	230	230	230
	at 60 Hz power frequency	V	230	230	230	230
Current type			1N~	1N~	1N~	1N~
Nominal power		kW	0.30	0.35	0.85	1.65
Nominal power with option internal socket		kW	0.80	0.85	1.35	2.15

Chamber size		BD 56	BD 115	BD 260	BD 720	
<b>Electrical data (continued)</b>						
Power plug of the power cable		shock proof plug				
Chamber fuse (external) 5x20 mm / 250V / time-lag (T)	A	6.3	6.3	8.0	12.5	
Overtemperature protective device class 1	°C	120	120	120	120	
Installation category acc. to IEC 61010-1		II	II	II	II	
Pollution degree acc. to IEC 61010-1		2	2	2	2	
<b>Different electrical data for BD-UL constructed for the USA and Canada</b> (model versions BD056UL-120V, BD115UL-120V, BD260UL-120V, BD720UL-240V)						
Nominal voltage (+/-10%)	at 50 Hz power frequency	V	115	115	115	240
	at 60 Hz power frequency	V	115	115	115	240
Current type		1N~	1N~	1N~	2~	
Nominal power	kW	0,30	0,35	0,95	1,75	
Power plug of the power cable	NEMA	5-15P	5-15P	5-15P	6-20P	
Chamber fuse (external) 5x20 mm / 250V / time-lag (T)	A	12.5	12.5	12.5	---	
Miniature circuit breaker (internal)	A	---	---	---	16	
<b>Environment-specific data</b>						
Energy consumption at 37 °C / 98.6 °F	Wh/h	25	25	40	78	

\*\*\* Data not yet determined

All technical data is specified for unloaded chambers with standard equipment at an ambient temperature of +22 °C +/- 3°C / 71.6 °F +/- 5.4 °F and a power supply voltage fluctuation of +/-10%. Technical data is determined in accordance to BINDER Factory Standard Part 2:2015 and DIN 12880:2007.

**All indications are average values, typical for chambers produced in series. We reserve the right to change technical specifications at any time.**

	If the chamber is fully loaded, the specified heating up times may vary according to the load.
---	--

	With option interior socket: If electrical devices are connected and operating inside the chamber, the temperature range may be modified due to heat emission.
---	--

## 16.5 BF technical data

Chamber size		BF 56	BF 115	BF 260	BF 720
<b>Exterior dimensions</b>					
Width, net	mm / inch	560 / 22.01	710 / 27.95	815 / 32.09	1165 / 45.87
Height, gross (incl. feet)	mm / inch	625 / 24.60	735 / 28.94	965 / 37.99	1590 / 62.60
Depth, net	mm / inch	565 / 22.24	605 / 23.82	760 / 29.92	816 / 32.13
Depth, gross (incl. door handle and exhaust duct)	mm / inch	640 / 25.20	680 / 26.77	815 / 32.09	870 / 34.25
Wall clearance rear (minimum)	mm / inch	160 / 6.30	160 / 6.30	160 / 6.30	160 / 6.30
Wall clearance side (minimum)	mm / inch	100 / 3.94	100 / 3.94	100 / 3.94	100 / 3.94
Exhaust duct, outer diameter	mm / inch	52 / 2.05	52 / 2.05	52 / 2.05	52 / 2.05
<b>Doors</b>					
Number of doors		1	1	1	2
Number of inner glass doors		1	1	1	2
<b>Interior dimensions</b>					
Width	mm / inch	400 / 15.75	550 / 21.65	650 / 25.59	1000 / 39.37
Height	mm / inch	440 / 17.32	550 / 21.65	780 / 30.71	1300 / 51.18
Depth	mm / inch	340 / 13.39	380 / 14.96	510 / 20.08	560 / 22.05

Chamber size		BF 56	BF 115	BF 260	BF 720	
<b>Interior dimensions (continued)</b>						
Interior volume	l / cu.ft.	59 / 2.08	114 / 4.03	257 / 9.08	***	
Steam space volume	l / cu.ft.	66 / 2.33	127 / 4.49	279 / 9.85	***	
<b>Racks</b>						
Quantity of racks (regular)		2	2	2	2	
Quantity of racks (max.)		4	5	8	16	
Max. load per rack (standard rack)	Kg / lbs	30 / 66	30 / 66	40 / 88	45 / 99	
Max. load per rack (optional perforated shelf)	Kg / lbs	35 / 77	35 / 77	35 / 77	35 / 77	
Max. load per rack (optional heavy load rack)	Kg / lbs	50 / 110	70 / 154	80 / 176	70 / 154	
Permitted total load	Kg / lbs	70 / 154	150 / 330	270 / 595	315 / 694	
<b>Weight</b>						
Weight (empty)	Kg / lbs	39 / 86	54 / 119	85 / 187	166 / 366	
<b>Temperature data</b>						
Temperature range	from ... degrees above ambient	°C / °F	7 / 12.6	8 / 14.4	7 / 12.6	10 / 18
	up to	°C / °F	100 / 212	100 / 212	100 / 212	100 / 212
Temperature fluctuation at 37 °C / 98.6 °F		± K	0.1	0.1	0.1	0.1
Temperature uniformity (variation) at 37 °C / 98.6 °F		± K	0.3	0.3	0.3	0.3
Heating up time to 37 °C / 98.6 °F		minutes	8	8	8	15
Recovery time after door was opened for 30 sec at 37 °C / 98.6 °F		minutes	3	4	4	4
<b>Electrical data</b> (model versions BF056-230V, BF115-230V, BF260-230V, BF720-230V)						
System of protection acc. to EN 60529		IP	20	20	20	20
Nominal voltage (+/-10%)	at 50 Hz power frequency	V	230	230	230	230
	at 60 Hz power frequency	V	230	230	230	230
Current type			1N~	1N~	1N~	1N~
Nominal power		kW	0.40	0.40	0.90	1.75
Nominal power with option internal socket		kW	0.90	0.95	1.45	2.25
Power plug of the power cable			shock proof plug			
Chamber fuse (external) 5x20 mm / 250V / time-lag (T)		A	6.3	6.3	8.0	12.5
Overtemperature protective device class 1		°C	120	120	120	120
Installation category acc. to IEC 61010-1			II	II	II	II
Pollution degree acc. to IEC 61010-1			2	2	2	2
<b>Different electrical data for BF-UL constructed for the USA and Canada</b> (model versions BF056UL-120V, BF115UL-120V, BF260UL-120V, BF720UL-240V)						
Nominal voltage (+/-10%)	at 50 Hz power frequency	V	115	115	115	240
	at 60 Hz power frequency	V	115	115	115	240
Current type			1N~	1N~	1N~	2~
Power plug of the power cable		NEMA	5-15P	5-15P	5-15P	6-20P
Nominal power		kW	0.40	0.40	1.00	1.85
Chamber fuse (external) 5x20 mm / 250V / time-lag (T)		A	12.5	12.5	12.5	---
Miniature circuit breaker (internal)		A	---	---	---	16

Chamber size		BF 56	BF 115	BF 260	BF 720
<b>Environment-specific data</b>					
Noise level (mean value)	dB (A)	43	43	43	43
Energy consumption at 37 °C / 98.6 °F	Wh/h	60	60	70	130

\*\*\* Data not yet determined

All technical data is specified for unloaded chambers with standard equipment at an ambient temperature of +22 °C +/- 3°C / 71.6 °F +/- 5.4 °F and a power supply voltage fluctuation of +/-10%. Technical data is determined in accordance to BINDER Factory Standard Part 2:2015 and DIN 12880:2007.

**All indications are average values, typical for chambers produced in series. We reserve the right to change technical specifications at any time.**

	If the chamber is fully loaded, the specified heating up times may vary according to the load.
---	--

	With option interior socket: If electrical devices are connected and operating inside the chamber, the temperature range may be modified due to heat emission.
---	--

## 16.6 ED technical data

Chamber size		ED 56	ED 115	ED 260	ED 720
<b>Exterior dimensions</b>					
Width, net	mm / inch	560 / 22.01	710 / 27.95	815 / 32.09	1165 / 45.87
Height, gross (incl. feet)	mm / inch	625 / 24.60	735 / 28.94	965 / 37.99	1590 / 62.60
Depth, net	mm / inch	565 / 22.24	605 / 23.82	760 / 29.92	816 / 32.13
Depth, gross (incl. door handle and exhaust duct)	mm / inch	640 / 25.20	680 / 26.77	815 / 32.09	870 / 34.25
Wall clearance rear (minimum)	mm / inch	160 / 6.30	160 / 6.30	160 / 6.30	160 / 6.30
Wall clearance side (minimum)	mm / inch	100 / 3.94	100 / 3.94	100 / 3.94	100 / 3.94
Exhaust duct, outer diameter	mm / inch	52 / 2.05	52 / 2.05	52 / 2.05	52 / 2.05
<b>Doors</b>					
Number of door(s)		1	1	1	2
<b>Interior dimensions</b>					
Width	mm / inch	360 / 14.17	510 / 20.08	610 / 24.02	960 / 37.80
Height	mm / inch	420 / 16.54	530 / 20.87	760 / 29.92	1280 / 50.39
Depth	mm / inch	380 / 14.96	425 / 16.73	550 / 21.65	610 / 24.02
Interior volume	l / cu.ft.	57 / 2.01	114 / 4.03	255 / 9.01	***
Steam space volume	l / cu.ft.	63	127 / 4.49	273 / 9.64	***
<b>Racks</b>					
Quantity of racks (regular)		2	2	2	2
Quantity of racks (max.)		4	5	8	16
Max. load per rack (standard rack)	Kg / lbs	30 / 66	30 / 66	44 / 88	45 / 99
Max. load per rack (optional perforated shelf)	Kg / lbs	35 / 77	35 / 77	35 / 77	35 / 77
Max. load per rack (optional heavy load rack)	Kg / lbs	50 / 110	70 / 154	80 / 176	70 / 154
Permitted total load	Kg / lbs	70 / 154	150 / 330	270 / 595	315 / 694
<b>Weight</b>					
Weight (empty)	Kg / lbs	39 / 86	54 / 119	85 / 187	169 / 373

Chamber size			ED 56	ED 115	ED 260	ED 720
<b>Temperature data</b>						
Temperature range	from ... degrees above ambient	°C / °F	5 / 9	6 / 10.8	5 / 9	5 / 9
	up to	°C / °F	300 / 572	300 / 572	300 / 572	300 / 572
Temperature fluctuation at 150 °C / 302 °F		± K	0.5	0.4	1.0	0.8
Temperature uniformity (variation) at 150 °C / 302 °F		± K	2.5	2.0	2.0	3,2
Heating up time to 150 °C / 302 °F		minutes	45	46	55	85
Recovery time after door was opened for 30 sec at 150 °C / 302 °F		minutes	35	16	20	25
<b>Electrical data</b> (model versions ED056-230V, ED115-230V, ED260-230V, ED720-400V)						
IP system of protection acc. to EN 60529		IP	20	20	20	20
Nominal voltage (+/-10%)	at 50 Hz power frequency	V	230	230	230	400
	at 60 Hz power frequency	V	230	230	230	400
Current type			1N~	1N~	1N~	3N~
Nominal power		kW	1.05	1.25	2.25	4.10
Power plug of the power cable			shock proof plug			
Chamber fuse (external) 5x20 mm / 250V / time-lag (T)		A	6.3	6.3	12.5	---
Miniature circuit breaker (internal)		A	---	---	---	16
Overtemperature protective device class 1		°C	330	330	330	330
Installation category acc. to IEC 61010-1			II	II	II	II
Pollution degree acc. to IEC 61010-1			2	2	2	2
<b>Different electrical data for ED-UL constructed for the USA and Canada</b> (model versions ED056UL-120V, ED115UL-120V, ED260UL-240V)						
Nominal voltage (+/-10%)	at 50 Hz power frequency	V	115	115	240	---
	at 60 Hz power frequency	V	115	115	240	---
Current type			1N~	1N~	2~	---
Power plug of the power cable		NEMA	5-15P	5-15P	6-20P	---
Nominal power		kW	1.15	1.35	2.45	---
Chamber fuse (external) 5x20 mm / 250V / time-lag (T)		A	12.5	12.5	---	---
Miniature circuit breaker (combination element, external)		A	---	---	16	---
<b>Environment-specific data</b>						
Energy consumption at 150 °C / 302 °F		Wh/h	180	250	370	700

\*\*\* Data not yet determined

All technical data is specified for unloaded chambers with standard equipment at an ambient temperature of +22 °C +/- 3°C / 71.6 °F +/- 5.4 °F and a power supply voltage fluctuation of +/-10%. Technical data is determined in accordance to BINDER Factory Standard Part 2:2015 and DIN 12880:2007.

**All indications are average values, typical for chambers produced in series. We reserve the right to change technical specifications at any time.**



If the chamber is fully loaded, the specified heating up times may vary according to the load.

## 16.7 FD technical data

Chamber size		FD 56	FD 115	FD 260	FD 720	
<b>Exterior dimensions</b>						
Width, net	mm / inch	560 / 22.01	710 / 27.95	815 / 32.09	1165 / 45.87	
Height, gross (incl. feet)	mm / inch	625 / 24.60	735 / 28.94	965 / 37.99	1590 / 62.60	
Depth, net	mm / inch	565 / 22.24	605 / 23.82	760 / 29.92	816 / 32.13	
Depth, gross (incl. door handle and exhaust duct)	mm / inch	640 / 25.20	680 / 26.77	815 / 32.09	870 / 34.25	
Wall clearance rear (minimum)	mm / inch	160 / 6.30	160 / 6.30	160 / 6.30	160 / 6.30	
Wall clearance side (minimum)	mm / inch	100 / 3.94	100 / 3.94	100 / 3.94	100 / 3.94	
Exhaust duct, outer diameter	mm / inch	52 / 2.05	52 / 2.05	52 / 2.05	52 / 2.05	
<b>Doors</b>						
Number of door(s)		1	1	1		
<b>Interior dimensions</b>						
Width	mm / inch	400 / 15.75	550 / 21.65	650 / 25.59	1000 / 39.37	
Height	mm / inch	440 / 17.32	550 / 21.65	780 / 30.71	1300 / 51.18	
Depth	mm / inch	345 / 13.58	385 / 15.16	510 / 20.08	570 / 22.44	
Interior volume	l / cu.ft.	60 / 2.12	116 / 4.10	257 / 9.08	***	
Steam space volume	l / cu.ft.	67 / 2.37	127 / 4.49	279 / 9.85	***	
<b>Racks</b>						
Quantity of racks (regular)		2	2	2	2	
Quantity of racks (max.)		4	5	8	16	
Max. load per rack (standard rack)	Kg / lbs	30 / 66	30 / 66	44 / 88	45 / 99	
Max. load per rack (optional perforated shelf)	Kg / lbs	35 / 77	35 / 77	35 / 77	35 / 77	
Max. load per rack (optional heavy load rack)	Kg / lbs	50 / 110	70 / 154	80 / 176	70 / 154	
Permitted total load	Kg / lbs	70 / 154	150 / 330	270 / 595	315 / 694	
<b>Weight</b>						
Weight (empty)	Kg / lbs	39 / 86	54 / 119	85 / 187	166 / 366	
<b>Temperature data</b>						
Temperature range	from ... degrees above ambient	°C / °F	10 / 18	10 / 18	10 / 18	12 / 21.6
	up to	°C / °F	300 / 572	300 / 572	300 / 572	300 / 572
Temperature fluctuation at 150 °C / 302 °F	± K	0.3	0.3	0.5	0.6	
Temperature uniformity (variation) at 150 °C / 302 °F	± K	1.7	1.7	1.9	2.5	
Heating up time to 150 °C / 302 °F	minutes	15	19	20	25	
Recovery time after door was opened for 30 sec at 150 °C / 302 °F	minutes	4	5	6	6	
<b>Ventilation data</b>						
Air change	at 100 °C / 212 °F	x/h	80	32	9	***
<b>Electrical data</b> (model versions FD056-230V, FD115-230V, FD260-230V, FD720-400V)						
System of protection acc. to EN 60529	IP	20	20	20	20	
Nominal voltage (+/-10%)	at 50 Hz power frequency	V	230	230	230	400
	at 60 Hz power frequency	V	230	230	230	400



Chamber size		FD 56	FD 115	FD 260	FD 720	
<b>Electrical data</b> (continued) (model versions FD056-230V, FD115-230V, FD260-230V, FD720-400V)						
Current type		1N~	1N~	1N~	3N~	
Nominal power	kW	1.10	1.30	2.30	4.50	
Power plug of the power cable		shock proof plug				
Chamber fuse (external) 5x20 mm / 250V / time-lag (T)	A	6.3	6.3	12.5	---	
Miniature circuit breaker (internal)	A	---	---	---	16	
Overtemperature protective device class 1	°C	330	350	330	330	
Installation category acc. to IEC 61010-1		II	II	II	II	
Pollution degree acc. to IEC 61010-1		2	2	2	2	
<b>Different electrical data for FD-UL constructed for the USA and Canada</b> (model versions FD056UL-120V, FD115UL-120V, FD260UL-240V)						
Nominal voltage (+/-10%)	at 50 Hz power frequency	V	115	115	240	---
	at 60 Hz power frequency	V	115	115	240	---
Current type		1N~	1N~	2~	---	
Nominal power	kW	1.20	1.40	2.50	---	
Power plug of the power cable	NEMA	5-15P	5-15P	6-20P	---	
Chamber fuse (external) 5x20 mm / 250V / time-lag (T)	A	12.5	12.5	---	---	
Miniature circuit breaker (combination element)	A	---	---	16	---	
<b>Environment-specific data</b>						
Noise level (mean value)	dB (A)	43	43	43	43	
Energy consumption at 150 °C / 302 °F	Wh/h	300	340	420	800	

\*\*\* Data not yet determined

All technical data is specified for unloaded chambers with standard equipment at an ambient temperature of +22 °C +/- 3°C / 71.6 °F +/- 5.4 °F and a power supply voltage fluctuation of +/-10%. Technical data is determined in accordance to BINDER Factory Standard Part 2:2015 and DIN 12880:2007.

**All indications are average values, typical for chambers produced in series. We reserve the right to change technical specifications at any time.**



If the chamber is fully loaded, the specified heating up times may vary according to the load.

## 16.8 FED technical data

Chamber size		FED 56	FED 115	FED 260	FED 720
<b>Exterior dimensions</b>					
Width, net	mm / inch	560 / 22.01	710 / 27.95	815 / 32.09	1165 / 45.87
Height, gross (incl. feet)	mm / inch	625 / 24.60	735 / 28.94	965 / 37.99	1590 / 62.60
Depth, net	mm / inch	565 / 22.24	605 / 23.82	760 / 29.92	816 / 32.13
Depth, gross (incl. door handle and exhaust duct)	mm / inch	640 / 25.20	680 / 26.77	815 / 32.09	870 / 34.25
Wall clearance rear (minimum)	mm / inch	160 / 6.30	160 / 6.30	160 / 6.30	160 / 6.30
Wall clearance side (minimum)	mm / inch	100 / 3.94	100 / 3.94	100 / 3.94	100 / 3.94
Exhaust duct, outer diameter	mm / inch	52 / 2.05	52 / 2.05	52 / 2.05	52 / 2.05
<b>Doors</b>					
Number of door(s)		1	1	1	

Chamber size		FED 56	FED 115	FED 260	FED 720	
<b>Interior dimensions</b>						
Width	mm / inch	400 / 15.75	550 / 21.65	650 / 25.59	1000 / 39.37	
Height	mm / inch	440 / 17.32	550 / 21.65	780 / 30.71	1300 / 51.18	
Depth	mm / inch	345 / 13.58	385 / 15.16	510 / 20.08	570 / 22.44	
Interior volume	l / cu.ft.	60 / 2.12	116 / 4.10	257 / 9.08	***	
Steam space volume	l / cu.ft.	67 / 2.37	127 / 4.49	279 / 9.85	***	
<b>Racks</b>						
Quantity of racks (regular)		2	2	2	2	
Quantity of racks (max.)		4	5	8	16	
Max. load per rack (standard rack)	Kg / lbs	30 / 66	30 / 66	44 / 88	45 / 99	
Max. load per rack (optional perforated shelf)	Kg / lbs	35 / 77	35 / 77	35 / 77	35 / 77	
Max. load per rack (optional heavy load rack)	Kg / lbs	50 / 110	70 / 154	80 / 176	70 / 154	
Permitted total load	Kg / lbs	70 / 154	150 / 330	270 / 595	315 / 694	
<b>Weight</b>						
Weight (empty)	Kg / lbs	39 / 86	54 / 119	85 / 187	162 / 357	
<b>Temperature data</b>						
Temperature range	from ... degrees above ambient	°C / °F	10 / 18	10 / 18	10 / 18	12 / 21.6
	up to	°C / °F	300 / 572	300 / 572	300 / 572	300 / 572
Temperature fluctuation at 150 °C / 302 °F		± K	0.3	0.3	0.5	0.6
Temperature uniformity (variation) at 150 °C / 302 °F		± K	1.4	1.2	1.6	2.0
Heating up time to 150 °C / 302 °F		minutes	15	19	20	25
Recovery time after door was opened for 30 sec at 150 °C / 302 °F		minutes	4	5	6	6
<b>Ventilation data</b>						
Air change	at 100 °C / 212 °F	x/h	80	32	9	***
<b>Electrical data</b> (model versions FED056-230V, FED115-230V, FED260-230V, FED720-400V)						
System of protection acc. to EN 60529		IP	20	20	20	20
Nominal voltage (+/-10%)	at 50 Hz power frequency	V	230	230	230	400
	at 60 Hz power frequency	V	230	230	230	400
Current type			1N~	1N~	1N~	3N~
Nominal power		kW	1.10	1.30	2.30	4.50
Power plug of the power cable			shock proof plug			
Chamber fuse (external) 5x20 mm / 250V / time-lag (T)		A	6.3	6.3	12.5	---
Miniature circuit breaker (internal)		A	---	---	---	16
Overtemperature protective device class 1		°C	330	350	330	330
Installation category acc. to IEC 61010-1			II	II	II	II
Pollution degree acc. to IEC 61010-1			2	2	2	2



Chamber size			FED 56	FED 115	FED 260	FED 720
<b>Different electrical data for FED-UL constructed for the USA and Canada</b> (model versions FED056UL-120V, FED115UL-120V, FED260UL-240V, FED720UL-208V)						
Nominal voltage (+/-10%)	at 50 Hz power frequency	V	115	115	240	208
	at 60 Hz power frequency	V	115	115	240	208
Current type			1N~	1N~	2~	3N~
Nominal power		kW	1.20	1.40	2.50	4.50
Power plug of the power cable		NEMA	5-15P	5-15P	6-20P	L21-20P
Chamber fuse (external) 5x20 mm / 250V / time-lag (T)		A	12.5	12.5	---	---
Miniature circuit breaker (combina- tion element, external)		A	---	---	16	---
Miniature circuit breaker (internal)		A	---	---	---	16
<b>Environment-specific data</b>						
Noise level (mean value)		dB (A)	43	43	43	43
Energy consumption at 150 °C / 302 °F		Wh/h	300	340	420	800

\*\*\* Data not yet determined

All technical data is specified for unloaded chambers with standard equipment at an ambient temperature of +22 °C +/- 3°C / 71.6 °F +/- 5.4 °F and a power supply voltage fluctuation of +/-10%. Technical data is determined in accordance to BINDER Factory Standard Part 2:2015 and DIN 12880:2007.

**All indications are average values, typical for chambers produced in series. We reserve the right to change technical specifications at any time.**



If the chamber is fully loaded, the specified heating up times may vary according to the load.

## 16.9 Equipment and options (extract)



To operate the chamber, use only original BINDER accessories or accessories / components from third-party suppliers authorized by BINDER. The user is responsible for any risk arising from using unauthorized accessories.

	BD	BF	ED	FD	FED
<b>Standard equipment</b>					
Microprocessor temperature controller	√	√	√	√	√
One timer function: Delayed Off	√		√	√	
Three timer functions: Delayed On, Delayed Off and Temperature dependent Delayed Off		√			√
Adjustable ramp function	√	√	√	√	√
Temperature safety controller class 3.1 acc. to DIN 12880:2007	√	√			
Temperature safety controller class 2 acc. to DIN 12880:2007			√	√	√
Inner glass door	√	√			
USB interface to read out the measured values	√	√	√	√	√
Communication interface Ethernet					√
Exhaust duct, internal diameter 50 mm / 1.97 inches, with adjustable ventilation slide	√	√	√	√	√
Adjustable air change by means of rear exhaust duct (50 mm)	√	√	√	√	√
2 racks, chrome-plated	√	√	√	√	√

Options / accessories					
Rack, chrome-plated or stainless steel	√	√	√	√	√
Perforated rack, stainless steel	√	√	√	√	√
Heavy load rack, stainless steel	√	√	√	√	√
Access ports with various diameters, with silicone plug	√	√	√	√	√
Door with window			√	√	√
Interior lightning	√	√	√	√	√
Communication interface Ethernet	√	√	√	√	
Battery backed real-time clock	√	√	√	√	√
Rubber pads for safe stacking (4 pieces)	√	√	√	√	√
Object temperature display with additional Pt100 temperature sensor	√	√	√	√	√
Disconnectable water protected internal socket (CA3GD) for line voltage inside the chamber, IP type of protection 67, 230 V 1N ~ 50-60 Hz. Max. load 500 W	√	√			
Analog output 4-20 mA for temperature with 6 pole DIN socket, DIN plug included	√	√	√	√	√
HEPA Fresh air filter, class H 14 (DIN EN 1822:2009)				√	√
Mostly gas-tight version		√		√	√
Inert gas connection (gas inlet and outlet), with mostly gas-tight version		√		√	√
Disconnectable audible over-temperature alarm	√	√	√	√	√
FKM door gasket (temperature resistant up to 200 °C / 392 °F max.)			√	√	√
Data Logger Kit T 220	√	√			
Data Logger Kit T 350			√	√	√
Measurement of air change rate acc. to ASTM D5374		√		√	√
Factory calibration certificate	√	√	√	√	√
Extension to factory calibration certificate (additional values)	√	√	√	√	√
Measuring protocol acc. to DIN 12880:2007	√	√	√	√	√
Qualification folder	√	√	√	√	√
Neutral cleaning agent (liquid concentrate)	√	√	√	√	√
Stable table on wheels with castors and locking brakes	√	√	√	√	√

## 16.10 Accessories and spare parts (extract)



BINDER GmbH is responsible for the safety features of the chamber only, provided skilled electricians or qualified personnel authorized by BINDER perform all maintenance and repair, and if components relating to chamber safety are replaced in the event of failure with original spare parts. The user is responsible for any risks arising from using unauthorized accessories/components.

Chamber size	56	115	260	720
Description	Art. No.			
Rack, chrome-plated BD, ED	6004-0174	6004-0175	6004-0177	6004-0179
Rack, chrome-plated BF, FD, FED	6004-0166	6004-0167	6004-0169	6004-0171
Rack, stainless steel BD, ED	6004-0158	6004-0159	6004-0161	6004-0163
Rack, stainless steel BF, FD, FED	6004-0150	6004-0151	6004-0153	6004-0155
Perforated rack, stainless steel BD, ED	6004-0190	6004-0191	6004-0193	6004-0195
Perforated rack, stainless steel BF, FD, FED	6004-0182	6004-0183	6004-0185	6004-0187
Rack, heavy load, stainless steel BD, ED	6004-0201	6004-0202	6004-0203	6004-0205
Rack, heavy load, stainless steel BF, FD, FED	6004-0198	6004-0199	6004-0200	6004-0204

Chamber size	56	115	260	720
<b>Description</b>	<b>Art. No.</b>			
Door gasket, silicone	6005-0254	6005-0255	6005-0258	6005-0260
Door gasket made of FKM (temperature resistant up to 200 °C / 392 °F max.)	6005-0265	6005-0266	6005-0268	6005-270
Stable table on wheels with castors and locking brakes	9051-0005	9051-0005	9051-0006	---
Chamber fuse 5x20mm 250V 6,3 A time lag (T)	5006-0092	5006-0092	---	---
Chamber fuse 5x20mm 250V 8,0 A time lag (T)	---	---	5006-0093	---
Chamber fuse 5x20mm 250V 12,5 A time lag (T)	5006-0096	5006-0096	5006-0096	---
External housing with HEPA Fresh air filter, class H 14 (DIN EN 1822:2009)	8012-1050	8012-1051	8012-1052	***

Description	Art. No.
HEPA fresh air filter (replacement) class H 14 (DIN EN 1822:2009)	6014-0003
Rubber pads for safe stacking (4 pieces)	8012-0001
Data Logger kit T 220	8012-0715
Data Logger kit T 350	8012-0714
Data Logger software	8012-0821
Neutral cleaning agent, 1 kg	1002-0016

Chamber type	BD	BF	ED	FD	FED
<b>Validation service</b>	<b>Art.-No.</b>				
Qualification folder IQ-OQ	8012-0870	8012-0871	8012-0761	8012-0792	8012-0855
Qualification folder IQ-OQ-PQ	8012-0958	8012-0959	8012-0942	8012-0943	8012-0944
Execution of IQ-OQ	DL400100	DL400100	DL400100	DL400100	DL400100
Execution of IQ-OQ-PQ	DL440500	DL440500	DL440500	DL440500	DL440500

Chamber type	BD	BF	ED	FD	FED
<b>Calibration service</b>	<b>Art.-No.</b>				
Calibration of temperature including certificate (1 measuring point)	DL300101	DL300101	DL300101	DL300101	DL300101
Spatial temperature measurement including certificate (9 measuring points)	DL300109	DL300109	DL300109	DL300109	DL300109
Spatial temperature measurement including certificate (18 measuring points)	DL300118	DL300118	DL300118	DL300118	DL300118
Spatial temperature measurement including certificate (27 measuring points)	DL300127	DL300127	DL300127	DL300127	DL300127
Measurement of air ventilation acc. to ASTM D 5374, including certificate	--	--	DL330000	DL330000	DL330000

For information on components not listed here, please contact BINDER Service.

### 16.11 Dimensions size 56

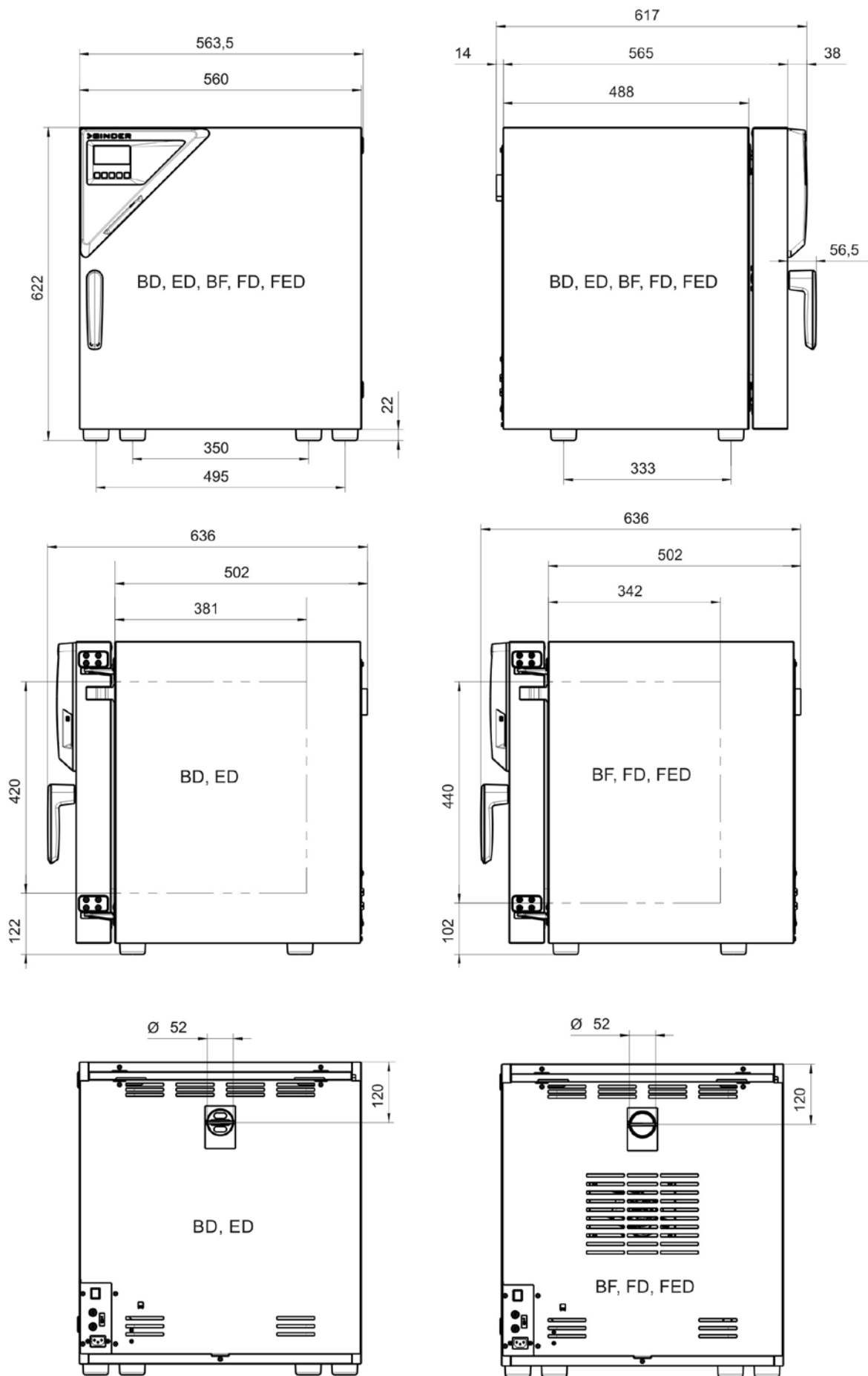

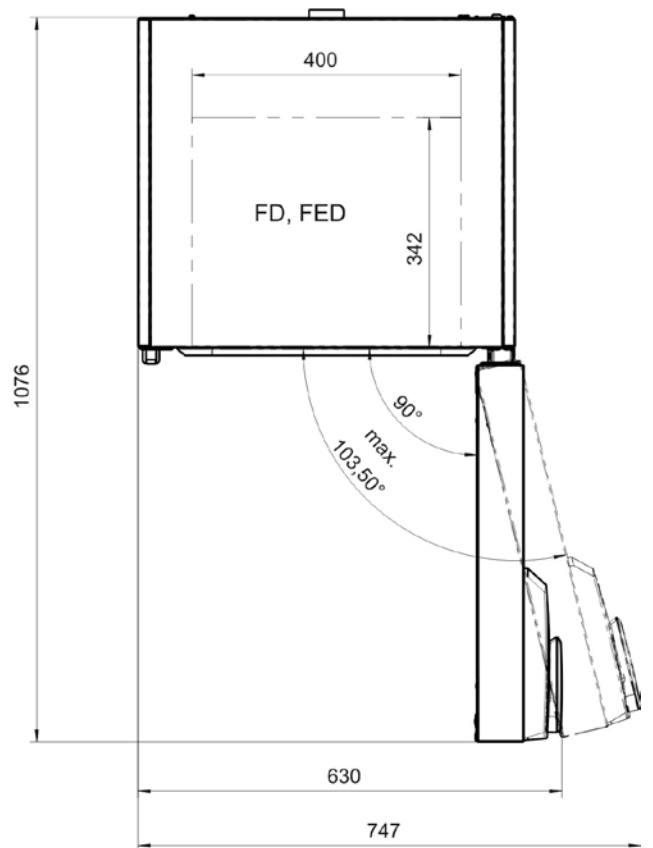
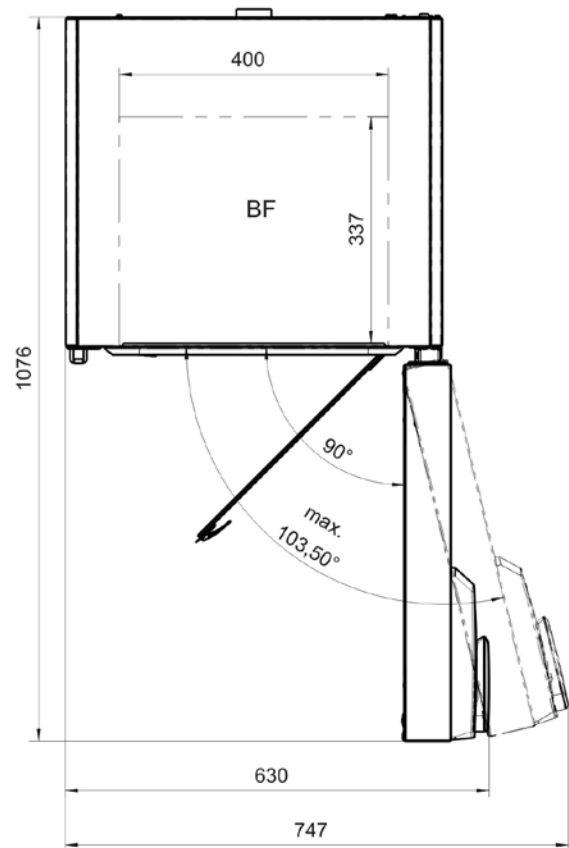
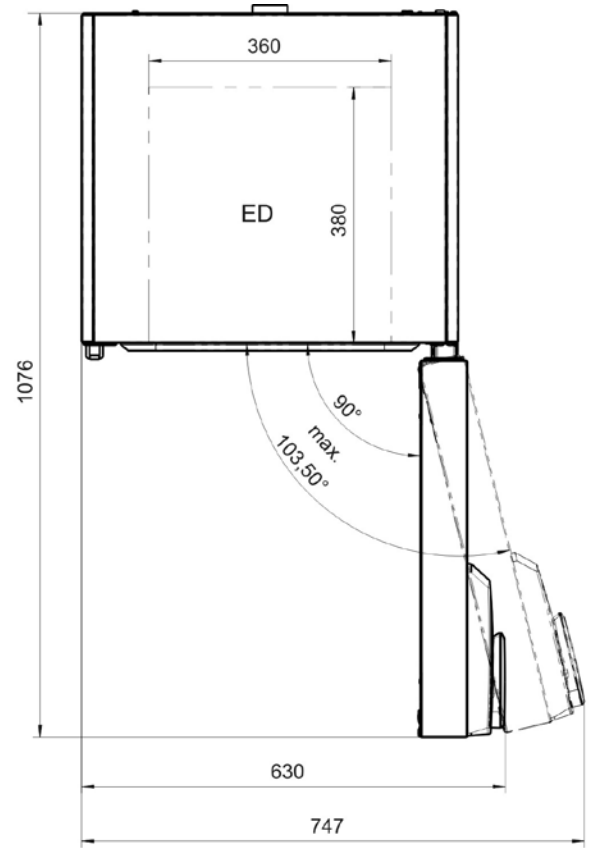
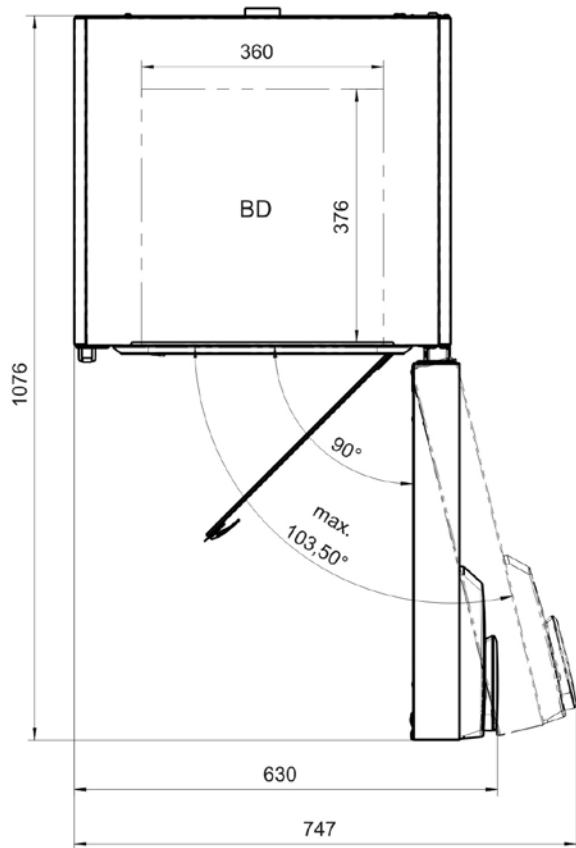

### 16.12 Dimensions size 115

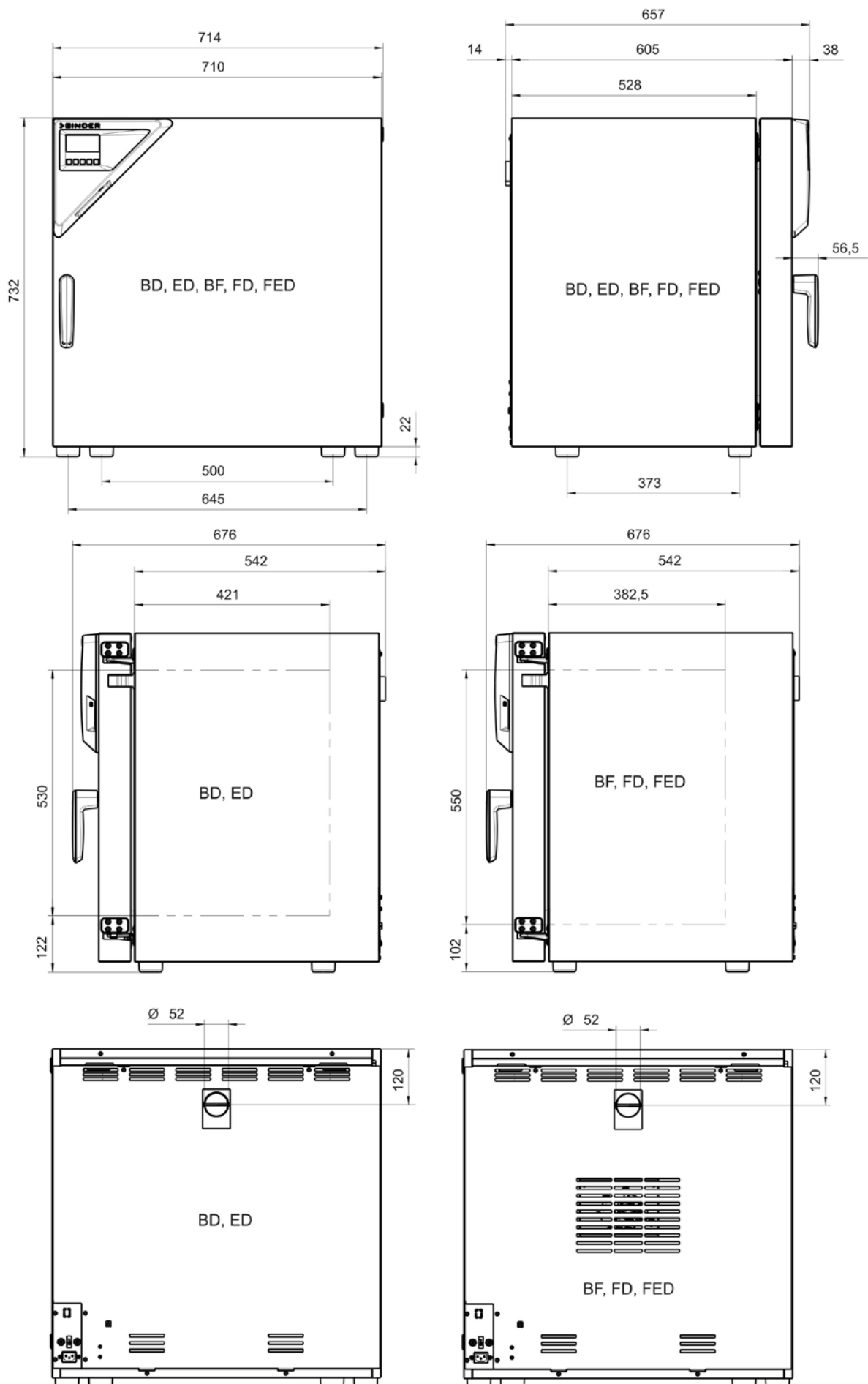

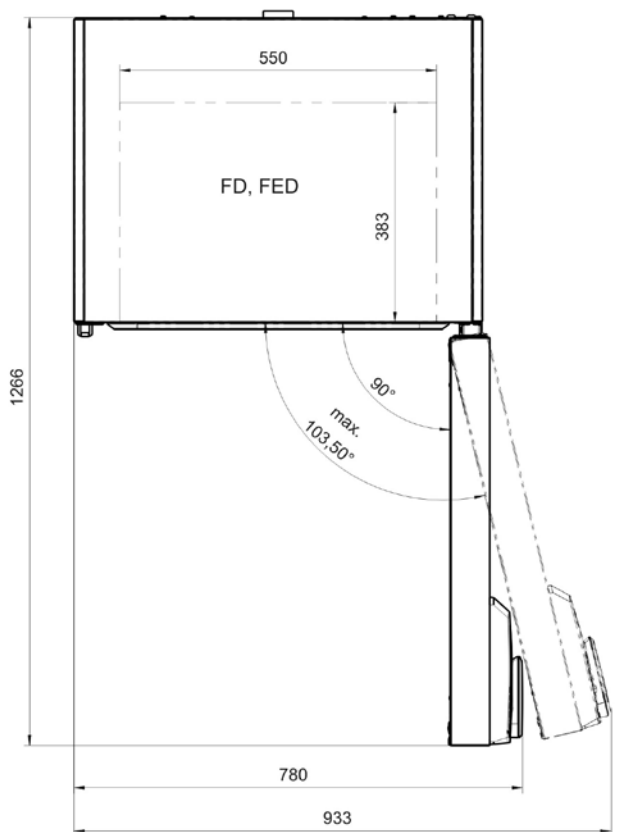
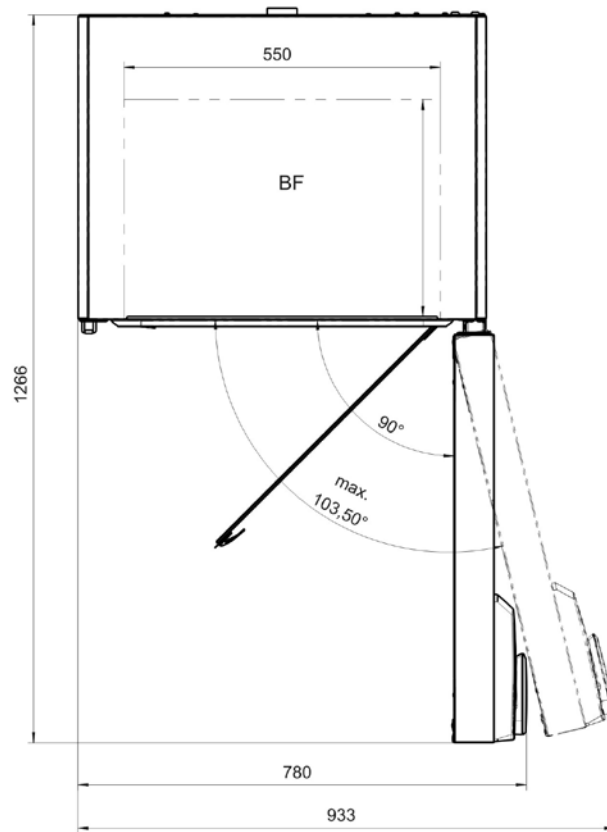
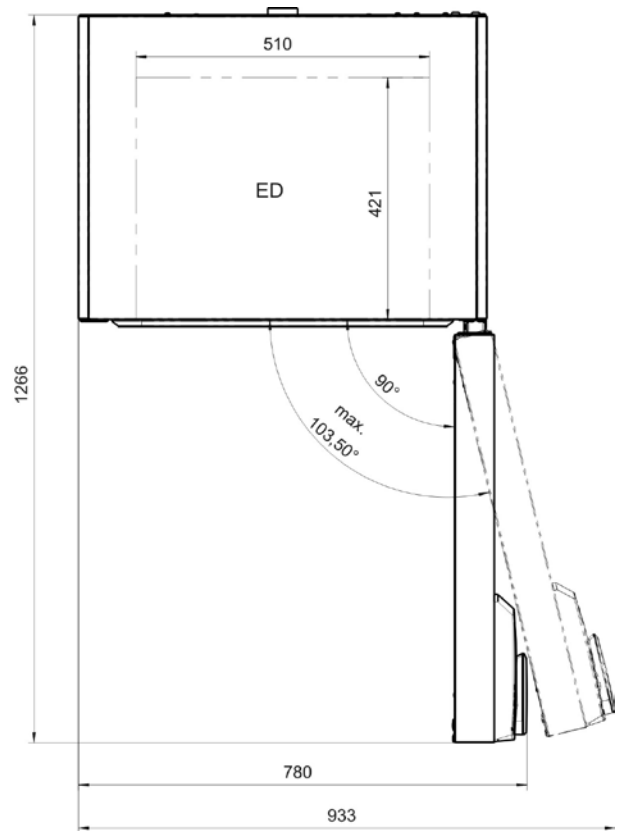
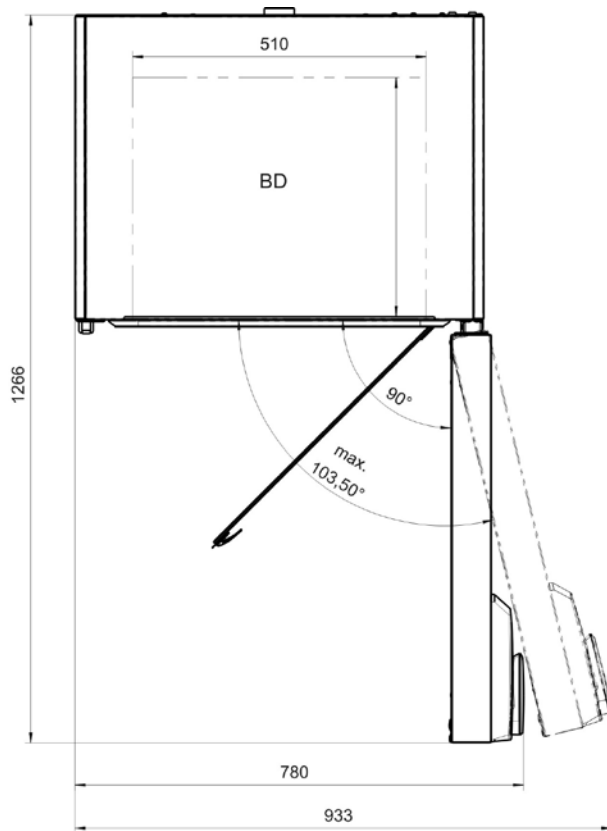

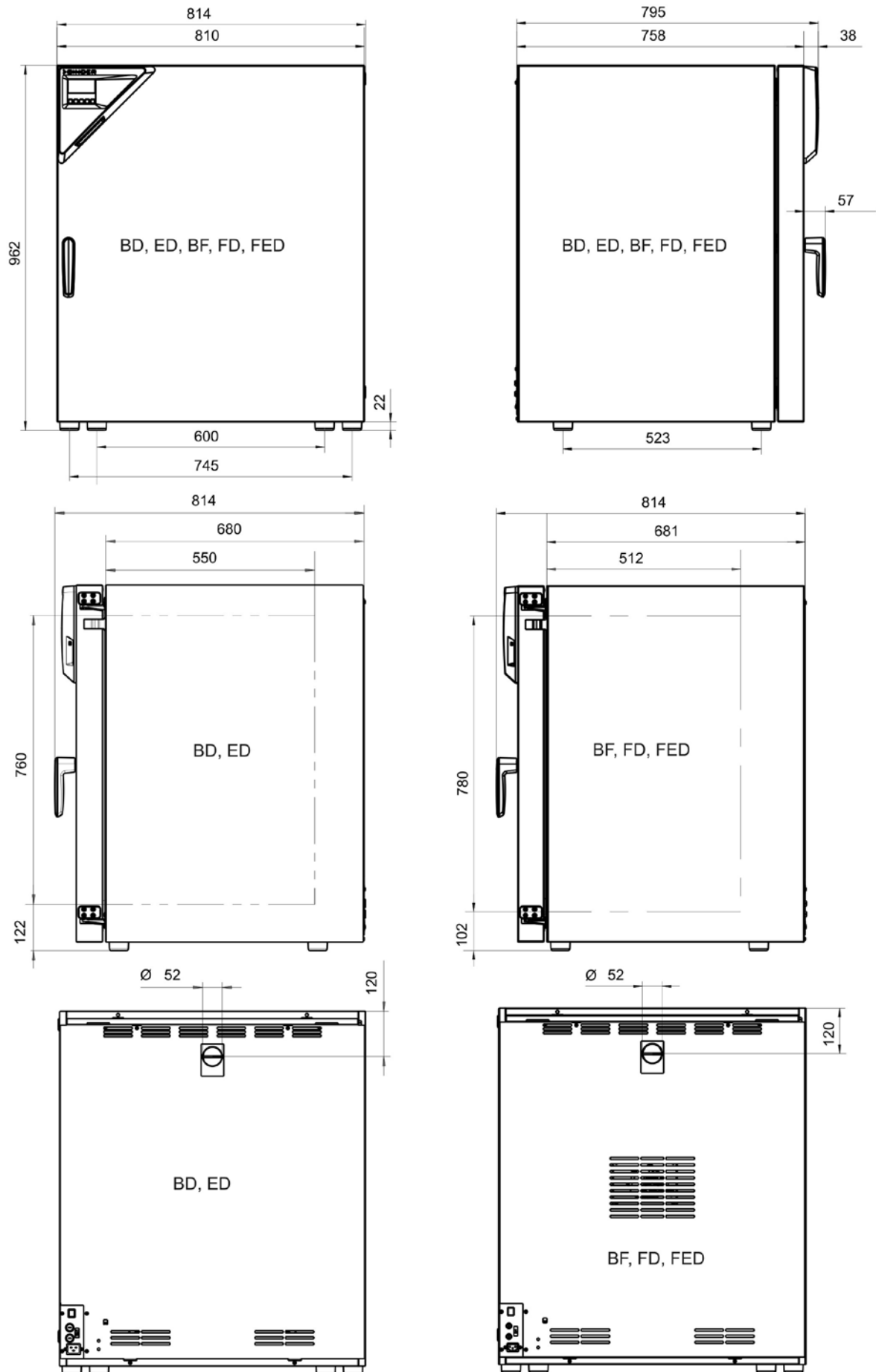
**16.13 Dimensions size 260**



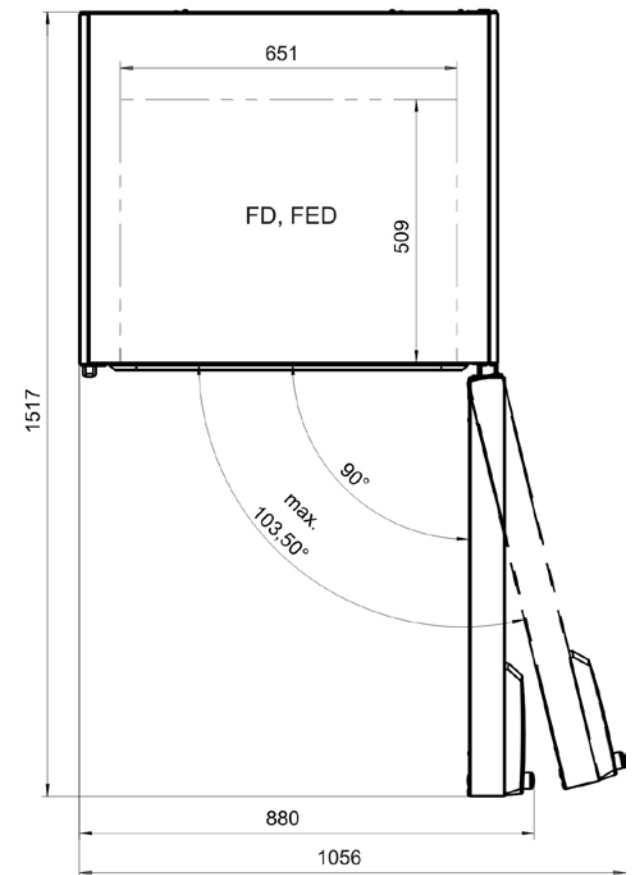
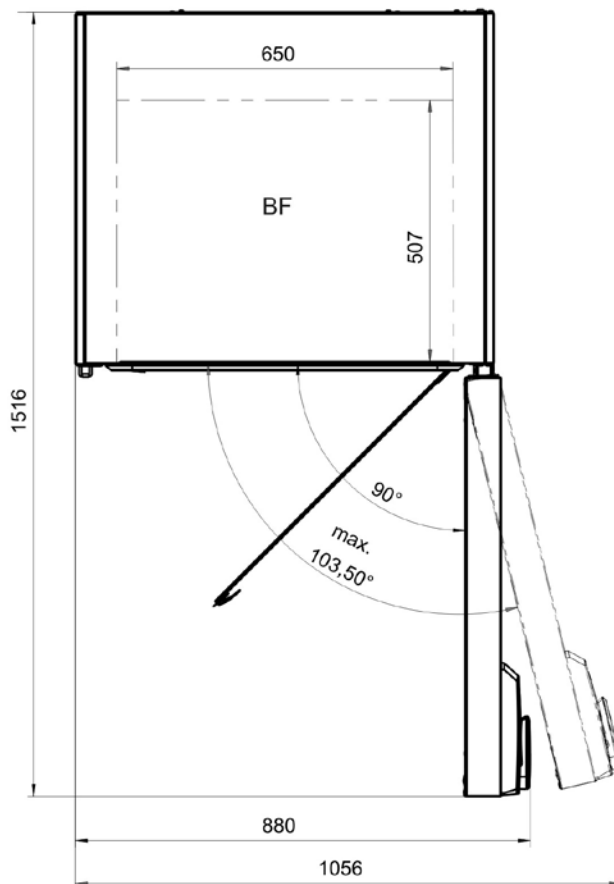
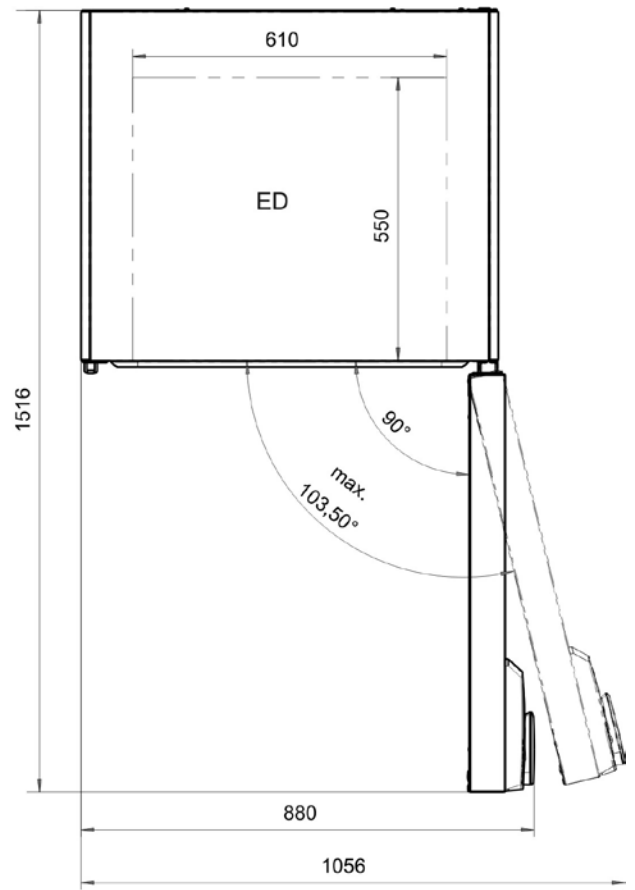
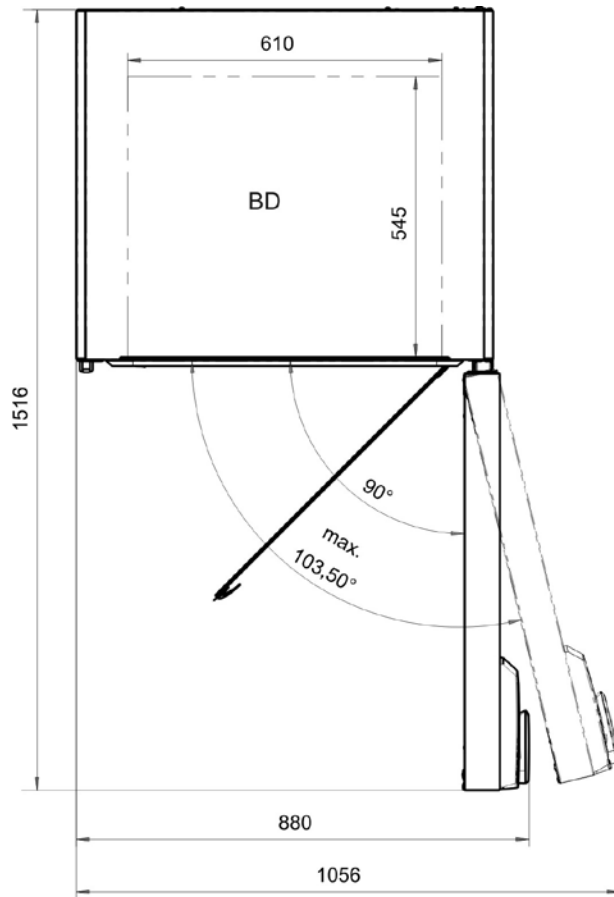

## 16.14 Dimensions size 720

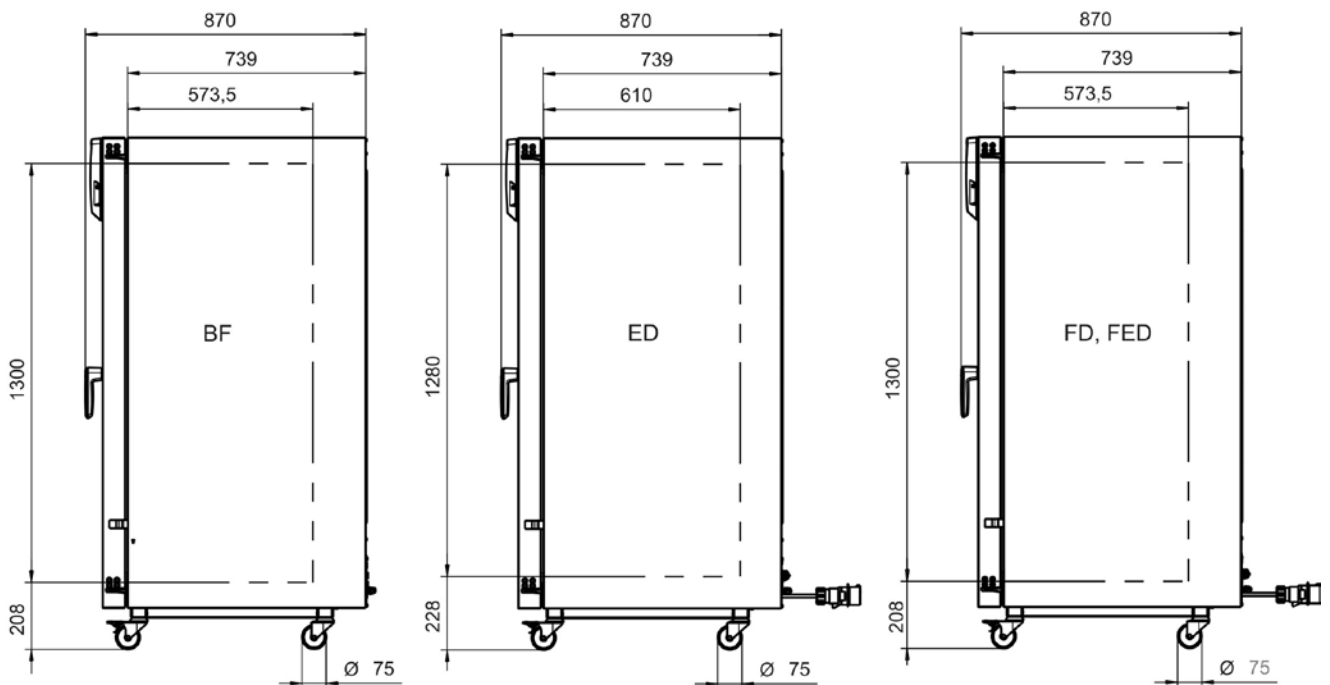
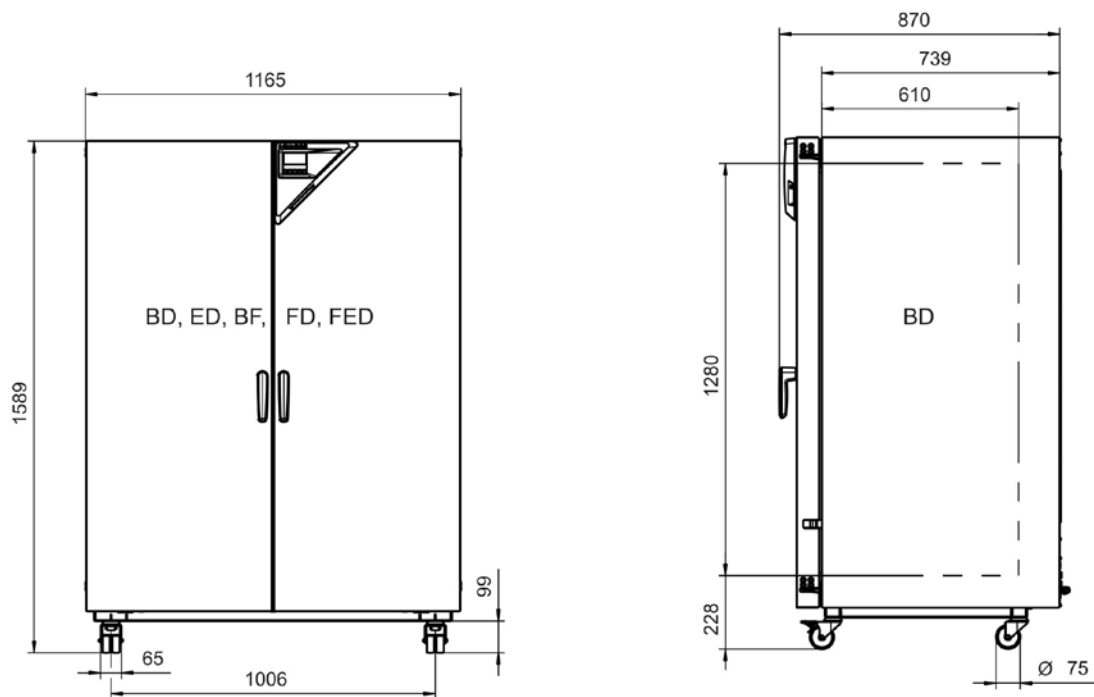

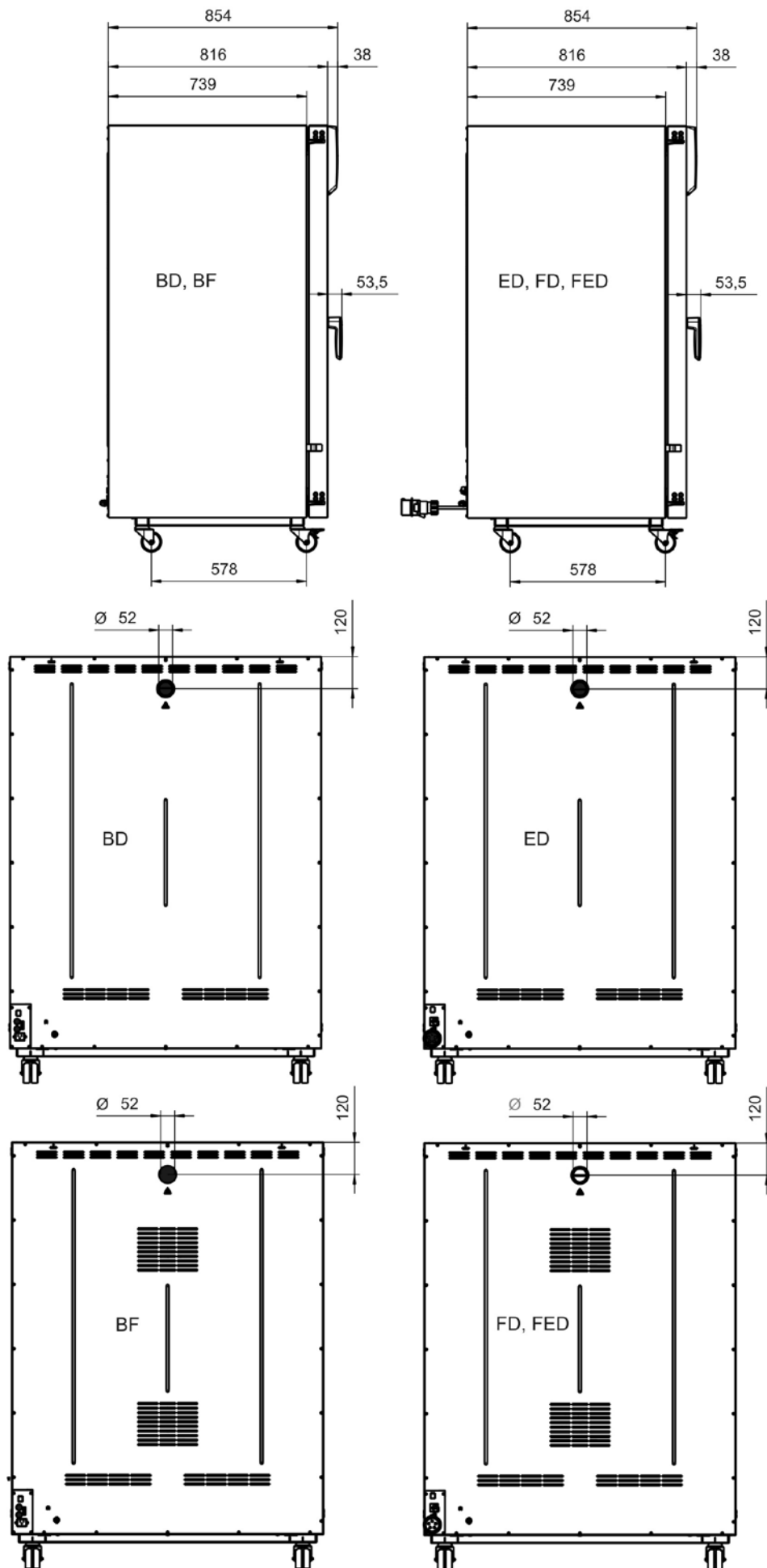

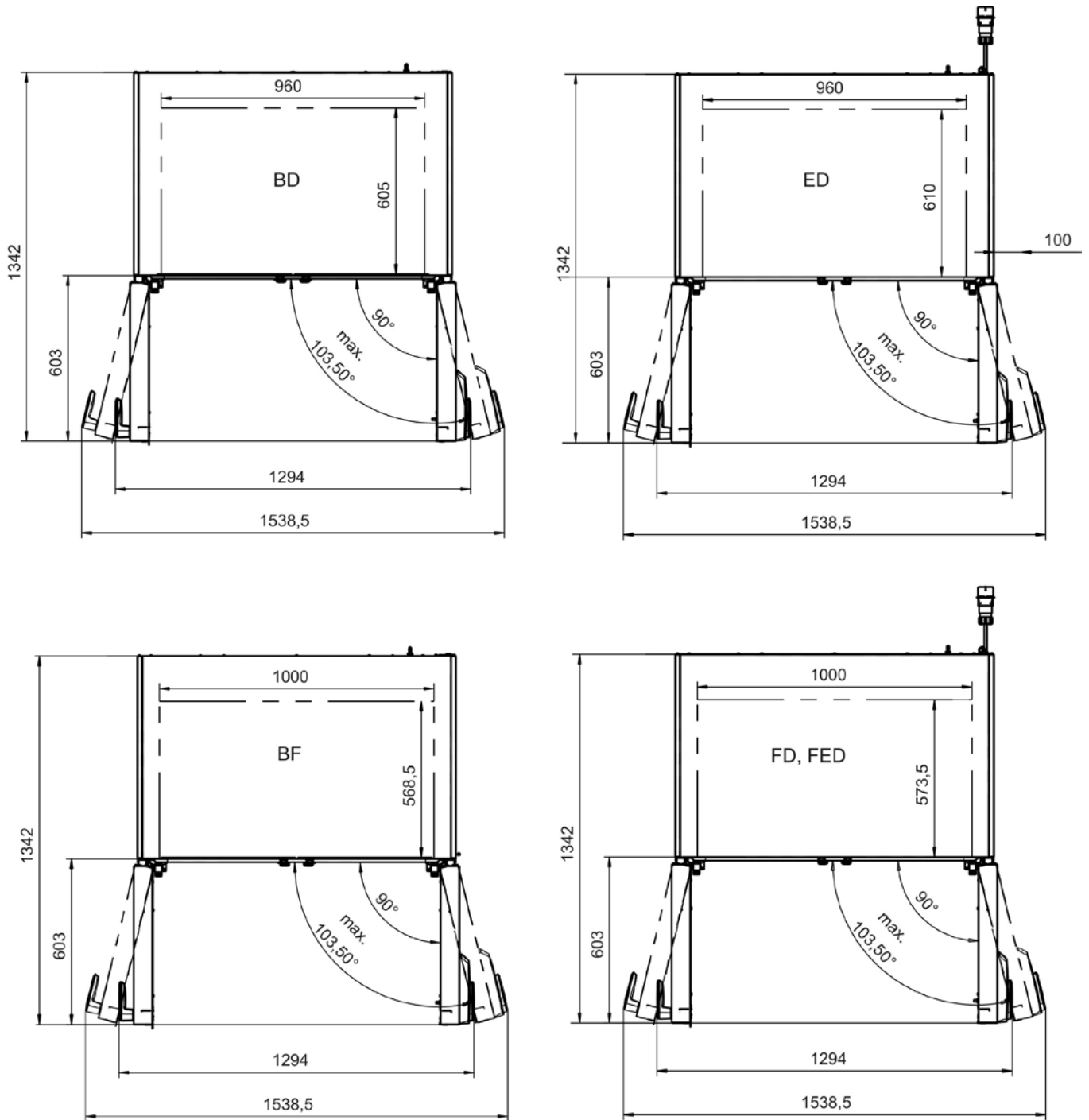



## 17. Certificates and declarations of conformity

### 17.1 EU Declaration of Conformity for BD



Best conditions for your success

	<b>EU-Konformitätserklärung / EU Declaration of Conformity / Déclaration de conformité UE / Declaración de conformidad UE / Dichiarazione di conformità UE / Декларация соответствия EU</b>
Hersteller / Manufacturer / Fabricant / Fabricante / Fabbicante / Производитель	BINDER GmbH
Anschrift / Address / Adresse / Dirección / Indirizzo / Адрес	Im Mittleren Ösch 5, 78532 Tuttlingen, Germany
Produkt / Product / Produit / Producto / Prodotto / Продукт	Inkubatoren mit freier Konvektion Incubators with natural convection Incubateurs à convection naturelle Incubadoras de convección natural Incubatori a convezione naturale Инкубаторы с естественной конвекцией
Typenbezeichnung / Type / Type / Tipo / Tipo / Тип	BD 56, BD 115, BD 260, BD 720

Das oben beschriebene Produkt ist konform mit folgenden EU-Richtlinien:  
 The product described above is in conformity with the following EU Directives:  
 Le produit décrit ci-dessus est conforme aux directives UE suivantes:  
 El producto descrito arriba cumple con las siguientes directivas de la UE:  
 Il prodotto sopra descritto è conforme alle seguenti direttive UE:  
 Продукты, указанные выше, полностью соответствуют следующим EU руководствам:

- **2014/35/EU**  
 Niederspannungsrichtlinie 2014/35/EU / Low voltage directive 2014/35/EU / Directive basse tension 2014/35/UE / Directiva sobre baja tensión 2014/35/UE / Direttiva Bassa tensione 2014/35/UE / Директива по низкому напряжению 2014/35/EU
- **2014/30/EU**  
 EMV-Richtlinie 2014/30/EU / EMC Directive 2014/30/EU / Directive CEM 2014/30/UE / Directiva CEM 2014/30/UE / Direttiva EMC 2014/30/UE / Директива ЭМС 2014/30/EU
- **2011/65/EU**  
 RoHS-Richtlinie 2011/65/EU / RoHS Directive 2011/65/EU / Directive RoHS 2011/65/UE / Directiva RoHS 2011/65/UE / Direttiva RoHS 2011/65/UE / Директива RoHS 2011/65/EU

Die oben beschriebenen Produkte tragen entsprechend die Kennzeichnung CE.  
 The products described above, corresponding to this, bear the CE-mark.  
 Les produits décrits ci-dessus, en correspondance, portent l'indication CE.  
 Los productos descritos arriba, en conformidad, llevan la indicación CE.  
 I prodotti sopra descritti, conformi a quanto sopra, portano il marchio CE.  
 Данные продукты в соответствии с изложенным выше маркированы знаком CE.

1 / 2

BINDER GmbH Postfach 102 D-78502 Tuttlingen **Anschrift:** BINDER GmbH Im Mittleren Ösch 5 D-78532 Tuttlingen  
**Kontakt:** Telefon: +49 (0) 74 62 / 20 05 – 0 | Telefax: +49 (0) 74 62 / 20 05 – 100 | info@binder-world.com | www.binder-world.com  
**Geschäftsführung:** Dipl.-Ing. Peter M. Binder | Amtsgericht Stuttgart, HRB 727150 | Sitz der Gesellschaft: Tuttlingen  
**Bankverbindung:** Kreissparkasse Tuttlingen Konto-Nr.: 2266 BLZ: 643 500 70 | IBAN-Code: DE05643 500700 000002266 | SWIFT-Code: SOLA DE S1TUT  
**\$ Account** 2202 611 55 | IBAN-Code: DE7464350070 0220 261155 | SWIFT-Code: SOLA DE S1TUT  
**Deutsche Bank Tuttlingen** Konto-Nr.: 2 138 709 BLZ: 653 700 75 | IBAN-Code: DE56653 70075 0213870900 | SWIFT-Code: DEUT DE SS663  
 Altgeräte-Entsorgung gemäß WEEE-Reg.-Nr. DE 37004963

Die oben beschriebenen Produkte sind konform mit folgenden harmonisierten Normen:  
The products described above are in conformity with the following harmonized standards:  
Les produits décrits ci-dessus sont conformes aux normes harmonisées suivantes:  
Los productos descritos arriba cumplen con las siguientes normas:  
I prodotti sopra descritti sono conformi alle seguenti normative armonizzate:  
Продукты, указанные выше, полностью соответствуют следующим стандартам:

Sicherheit / Safety / Sécurité / Seguridad / Sicurezza / Нормативы по безопасности
<ul style="list-style-type: none"><li>• EN 61010-1:2010</li><li>• EN 61010-2-010:2014</li></ul>
EMV / EMC / CEM / CEM / EMC / ЭМС
<ul style="list-style-type: none"><li>• EN 61326-1:2013</li></ul>
RoHS
<ul style="list-style-type: none"><li>• EN 50581:2012</li></ul>

78532 Tuttlingen, 23.10.2017  
BINDER GmbH



P. M. Binder  
Geschäftsführender Gesellschafter  
Managing Director  
Directeur général  
Director general  
Direttore Generale  
Генеральный Директор



J. Bollaender  
Leiter F & E  
Director R & D  
Chef de service R&D  
Responsable I & D  
Direttore R & D  
Глава департамента R&D

2 / 2

BINDER GmbH Postfach 102 D-78502 Tuttlingen **Anschrift:** BINDER GmbH Im Mittleren Ösch 5 D-78532 Tuttlingen  
**Kontakt:** Telefon: +49 (0) 74 62 / 20 05 - 0 | Telefax: +49 (0) 74 62 / 20 05 - 100 | info@binder-world.com | www.binder-world.com  
**Geschäftsführung:** Dipl.-Ing. Peter M. Binder | Amtsgericht Stuttgart, HRB 727150 | Sitz der Gesellschaft: Tuttlingen  
**Bankverbindung:** Kreissparkasse Tuttlingen Konto-Nr.: 2266 BLZ: 643 500 70 | IBAN-Code: DE05643 500700 000002266 | SWIFT-Code: SOLA DE 51TUT  
\$-Account 2202 611 55 | IBAN-Code: DE7464350070 0220 261155 | SWIFT-Code: SOLA DE 51TUT  
Deutsche Bank Tuttlingen Konto-Nr.: 2 138 709 BLZ: 653 700 75 | IBAN-Code: DE56653 70075 0213870900 | SWIFT-Code: DEUT DE 55603  
Altgeräte-Entsorgung gemäß WEEE-Reg.-Nr. DE 37004983



## 17.2 EU Declaration of Conformity for BF



**CE** EU-Konformitätserklärung / EU Declaration of Conformity / Déclaration de conformité UE / Declaración de conformidad UE / Dichiarazione di conformità UE / Декларация соответствия EU

Hersteller / Manufacturer / Fabricant / Fabricante / Fabbicante / Производитель	BINDER GmbH
Anschrift / Address / Adresse / Dirección / Indirizzo / Адрес	Im Mittleren Ösch 5, 78532 Tuttlingen, Germany
Produkt / Product / Produit / Producto / Prodotto / Продукт	Inkubatoren mit Umluft Incubators with forced convection Incubateurs à convection forcée Incubadoras de convección forzada Incubatori a convezione forzata Инкубаторы с принудительной циркуляцией воздуха
Typenbezeichnung / Type / Type / Tipo / Tipo / Тип	BF 56, BF 115, BF 260, BF 720

Das oben beschriebene Produkt ist konform mit folgenden EU-Richtlinien:

The product described above is in conformity with the following EU Directives:

Le produit décrit ci-dessus est conforme aux directives UE suivantes:

El producto descrito arriba cumple con las siguientes directivas de la UE:

Il prodotto sopra descritto è conforme alle seguenti direttive UE:

Продукты, указанные выше, полностью соответствуют следующим EU руководствам:

- 2014/35/EU**  
 Niederspannungsrichtlinie 2014/35/EU / Low voltage directive 2014/35/EU / Directive basse tension 2014/35/UE / Directiva sobre baja tensión 2014/35/UE / Direttiva Bassa tensione 2014/35/UE / Директива по низкому напряжению 2014/35/EU
- 2014/30/EU**  
 EMV-Richtlinie 2014/30/EU / EMC Directive 2014/30/EU / Directive CEM 2014/30/UE / Directiva CEM 2014/30/UE / Direttiva EMC 2014/30/UE / Директива ЭМС 2014/30/EU
- 2011/65/EU**  
 RoHS-Richtlinie 2011/65/EU / RoHS Directive 2011/65/EU / Directive RoHS 2011/65/UE / Directiva RoHS 2011/65/UE / Direttiva RoHS 2011/65/UE / Директива RoHS 2011/65/EU

Die oben beschriebenen Produkte tragen entsprechend die Kennzeichnung CE.

The products described above, corresponding to this, bear the CE-mark.

Les produits décrits ci-dessus, en correspondance, portent l'indication CE.

Los productos descritos arriba, en conformidad, llevan la indicación CE.

I prodotti sopra descritti, conformi a quanto sopra, portano il marchio CE.

Данные продукты в соответствии с изложенным выше маркированы знаком CE.

1 / 2

BINDER GmbH Postfach 102 D-78502 Tuttlingen **Anschrift:** BINDER GmbH Im Mittleren Ösch 5 D-78532 Tuttlingen  
**Kontakt:** Telefon: +49 (0) 74 62 / 20 05 - 0 | Telefax: +49 (0) 74 62 / 20 05 - 100 | info@binder-world.com | www.binder-world.com  
**Geschäftsführung:** Dipl.-Ing. Peter M. Binder | Amtsgericht Stuttgart, HRB 727150 | Sitz der Gesellschaft: Tuttlingen  
**Bankverbindung:** Kreissparkasse Tuttlingen Konto-Nr.: 2266 BLZ: 643 500 70 | IBAN-Code: DE05643 500700 000002266 | SWIFT-Code: SOLA DE 31TUT  
 \$-Account 2202 611 55 | IBAN-Code: DE7464350070 0220 261155 | SWIFT-Code: SOLA DE 31TUT  
 Deutsche Bank Tuttlingen Konto-Nr.: 2 138 709 BLZ: 653 700 75 | IBAN-Code: DE56653 70075 0213870900 | SWIFT-Code: DEUT DE 55603  
 Altgeräte-Entsorgung gemäß WEEE-Reg.-Nr. DE 37004983

Die oben beschriebenen Produkte sind konform mit folgenden harmonisierten Normen:  
 The products described above are in conformity with the following harmonized standards:  
 Les produits décrits ci-dessus sont conformes aux normes harmonisées suivantes:  
 Los productos descritos arriba cumplen con las siguientes normas:  
 I prodotti sopra descritti sono conformi alle seguenti normative armonizzate:  
 Продукты, указанные выше, полностью соответствуют следующим стандартам:

Sicherheit / Safety / Sécurité / Seguridad / Sicurezza / Нормативы по безопасности
<ul style="list-style-type: none"> <li>• EN 61010-1:2010</li> <li>• EN 61010-2-010:2014</li> </ul>
EMV / EMC / CEM / CEM / EMC / ЭМС
<ul style="list-style-type: none"> <li>• EN 61326-1:2013</li> </ul>
RoHS
<ul style="list-style-type: none"> <li>• EN 50581:2012</li> </ul>

78532 Tuttlingen, 23.10.2017  
 BINDER GmbH



P. M. Binder  
 Geschäftsführender Gesellschafter  
 Managing Director  
 Directeur général  
 Director general  
 Direttore Generale  
 Генеральный Директор



J. Bollaender  
 Leiter F & E  
 Director R & D  
 Chef de service R&D  
 Responsable I & D  
 Direttore R & D  
 Глава департамента R&D

2 / 2

BINDER GmbH Postfach 102 D-78502 Tuttlingen **Anschrift:** BINDER GmbH Im Mittleren Ösch 5 D-78532 Tuttlingen  
**Kontakt:** Telefon: +49 (0) 74 62 / 20 05 – 0 | Telefax: +49 (0) 74 62 / 20 05 – 100 | info@binder-world.com | www.binder-world.com  
**Geschäftsführung:** Dipl.-Ing. Peter M. Binder | Amtsgericht Stuttgart, HRB 727150 | Sitz der Gesellschaft: Tuttlingen  
**Bankverbindung:** Kreissparkasse Tuttlingen Konto-Nr.: 2266 BLZ: 643 500 70 | IBAN-Code: DE05643 500700 000002266 | SWIFT-Code: SOLA DE S1TUT  
**\$-Account** 2202 611 55 | IBAN-Code: DE7464350070 0220 261155 | SWIFT-Code: SOLA DE S1TUT  
**Deutsche Bank Tuttlingen** Konto-Nr.: 2 138 709 BLZ: 653 700 75 | IBAN-Code: DE56653 70075 0213870900 | SWIFT-Code: DEUT DE SS603  
 Altgeräte-Entsorgung gemäß WEEE-Reg.-Nr. DE 37004983



## 17.3 EU Declaration of Conformity for ED



Best conditions for your success

	<b>EU-Konformitätserklärung / EU Declaration of Conformity / Déclaration de conformité UE / Declaración de conformidad UE / Dichiarazione di conformità UE / Декларация соответствия EU</b>
Hersteller / Manufacturer / Fabricant / Fabricante / Fabbricante / Производитель	BINDER GmbH
Anschrift / Address / Adresse / Dirección / Indirizzo / Адрес	Im Mittleren Ösch 5, 78532 Tuttlingen, Germany
Produkt / Product / Produit / Producto / Prodotto / Продукт	Trocken- und Wärmeschränke mit freier Konvektion Drying and heating ovens with natural convection Etuves de chauffage et de séchage à convection naturelle Estufas de secado y calentamiento de convección natural Stufe per essiccazione e riscaldamento a convezione naturale Сушильные и сухожаровые шкафы с естественной конвекцией
Typenbezeichnung / Type / Type / Tipo / Tipo / Тип	ED 56, ED 115, ED 260, ED 720

Das oben beschriebene Produkt ist konform mit folgenden EU-Richtlinien:  
 The product described above is in conformity with the following EU Directives:  
 Le produit décrit ci-dessus est conforme aux directives UE suivantes:  
 El producto descrito arriba cumple con las siguientes directivas de la UE:  
 Il prodotto sopra descritto è conforme alle seguenti direttive UE:  
 Продукты, указанные выше, полностью соответствуют следующим EU руководствам:

<ul style="list-style-type: none"> <li>• <b>2014/35/EU</b>            Niederspannungsrichtlinie 2014/35/EU / Low voltage directive 2014/35/EU / Directive basse tension 2014/35/UE / Directiva sobre baja tensión 2014/35/UE / Direttiva Bassa tensione 2014/35/UE / Директива по низкому напряжению 2014/35/EU</li> <li>• <b>2014/30/EU</b>            EMV-Richtlinie 2014/30/EU / EMC Directive 2014/30/EU / Directive CEM 2014/30/UE / Directiva CEM 2014/30/UE / Direttiva EMC 2014/30/UE / Директива ЭМС 2014/30/EU</li> <li>• <b>2011/65/EU</b>            RoHS-Richtlinie 2011/65/EU / RoHS Directive 2011/65/EU / Directive RoHS 2011/65/UE / Directiva RoHS 2011/65/UE / Direttiva RoHS 2011/65/UE / Директива RoHS 2011/65/EU</li> </ul>
--

Die oben beschriebenen Produkte tragen entsprechend die Kennzeichnung CE.  
 The products described above, corresponding to this, bear the CE-mark.  
 Les produits décrits ci-dessus, en correspondance, portent l'indication CE.  
 Los productos descritos arriba, en conformidad, llevan la indicación CE.  
 I prodotti sopra descritti, conformi a quanto sopra, portano il marchio CE.  
 Данные продукты в соответствии с изложенным выше маркированы знаком CE.

1 / 2

BINDER GmbH Postfach 102 D-78502 Tuttlingen    Anschrift: BINDER GmbH Im Mittleren Ösch 5 D-78532 Tuttlingen  
 Kontakt: Telefon: +49 (0) 74 62 / 20 05 – 0 | Telefax: +49 (0) 74 62 / 20 05 – 100 | info@binder-world.com | www.binder-world.com  
 Geschäftsführung: Dipl.-Ing. Peter M. Binder | Amtsgericht Stuttgart, HRB 727150 | Sitz der Gesellschaft: Tuttlingen  
 Bankverbindung: Kreissparkasse Tuttlingen Konto-Nr.: 2266 BLZ: 643 500 70 | IBAN-Code: DE05643 500700 000002266 | SWIFT-Code: SOLA DE S1TUT  
 \$-Account 2202 611 55 | IBAN-Code: DE7464350070 0220 261155 | SWIFT-Code: SOLA DE S1TUT  
 Deutsche Bank Tuttlingen Konto-Nr.: 2 138 709 BLZ: 653 700 75 | IBAN-Code: DE56653 70075 0213870900 | SWIFT-Code: DEUT DE SS603  
 Altgeräte-Entsorgung gemäß WEEE-Reg.-Nr. DE 37004983

Die oben beschriebenen Produkte sind konform mit folgenden harmonisierten Normen:  
 The products described above are in conformity with the following harmonized standards:  
 Les produits décrits ci-dessus sont conformes aux normes harmonisées suivantes:  
 Los productos descritos arriba cumplen con las siguientes normas:  
 I prodotti sopra descritti sono conformi alle seguenti normative armonizzate:  
 Продукты, указанные выше, полностью соответствуют следующим стандартам:

Sicherheit / Safety / Sécurité / Seguridad / Sicurezza / Нормативы по безопасности
<ul style="list-style-type: none"> <li>• EN 61010-1:2010</li> <li>• EN 61010-2-010:2014</li> </ul>
EMV / EMC / CEM / CEM / EMC / ЭМС
<ul style="list-style-type: none"> <li>• EN 61326-1:2013</li> </ul>
RoHS
<ul style="list-style-type: none"> <li>• EN 50581:2012</li> </ul>

78532 Tuttlingen, 23.10.2017  
 BINDER GmbH

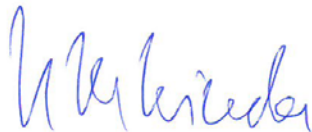

P. M. Binder  
 Geschäftsführender Gesellschafter  
 Managing Director  
 Directeur général  
 Director general  
 Direttore Generale  
 Генеральный Директор





J. Bollaender  
 Leiter F & E  
 Director R & D  
 Chef de service R&D  
 Responsable I & D  
 Direttore R & D  
 Глава департамента R&D

2 / 2

BINDER GmbH Postfach 102 D-78502 Tuttlingen **Anschrift:** BINDER GmbH Im Mittleren Ösch 5 D-78532 Tuttlingen  
**Kontakt:** Telefon: +49 (0) 74 62 / 20 05 - 0 | Telefax: +49 (0) 74 62 / 20 05 - 100 | info@binder-world.com | www.binder-world.com  
**Geschäftsführung:** Dipl.-Ing. Peter M. Binder | Amtsgericht Stuttgart, HRB 727150 | Sitz der Gesellschaft: Tuttlingen  
**Bankverbindung:** Kreissparkasse Tuttlingen Konto-Nr.: 2266 BLZ: 643 500 70 | IBAN-Code: DE05643 500700 000002266 | SWIFT-Code: SOLA DE S1TUT  
 \$-Account 2202 611 55 | IBAN-Code: DE7464350070 0220 261155 | SWIFT-Code: SOLA DE S1TUT  
 Deutsche Bank Tuttlingen Konto-Nr.: 2 136 709 BLZ: 653 700 75 | IBAN-Code: DE36653 70075 0213870900 | SWIFT-Code: DEUT DE 33603  
 Altgeräte-Entsorgung gemäß WEEE-Reg.-Nr. DE 37004983

## 17.4 EU Declaration of Conformity for FD

  
 Best conditions for your success

	<b>EU-Konformitätserklärung / EU Declaration of Conformity / Déclaration de conformité UE / Declaración de conformidad UE / Dichiarazione di conformità UE / Декларация соответствия EU</b>
Hersteller / Manufacturer / Fabricant / Fabricante / Fabbricante / Производитель	BINDER GmbH
Anschrift / Address / Adresse / Dirección / Indirizzo / Адрес	Im Mittleren Ösch 5, 78532 Tuttlingen, Germany
Produkt / Product / Produit / Producto / Prodotto / Продукт	Trocken- und Wärmeschränke mit Umluft Drying and heating ovens with forced convection Etuves de chauffage et de séchage à convection forcée Estufas de secado y calentamiento de convección forzada Stufe per essiccazione e riscaldamento a convezione forzata Сушильные и сухожаровые шкафы с принудительной конвекцией
Typenbezeichnung / Type / Type / Tipo / Tipo / Тип	FD 56, FD 115, FD 260, FD 720

Das oben beschriebene Produkt ist konform mit folgenden EU-Richtlinien:  
 The product described above is in conformity with the following EU Directives:  
 Le produit décrit ci-dessus est conforme aux directives UE suivantes:  
 El producto descrito arriba cumple con las siguientes directivas de la UE:  
 Il prodotto sopra descritto è conforme alle seguenti direttive UE:  
 Продукты, указанные выше, полностью соответствуют следующим EU руководствам:

- **2014/35/EU**  
 Niederspannungsrichtlinie 2014/35/EU / Low voltage directive 2014/35/EU / Directive basse tension 2014/35/UE / Directiva sobre baja tensión 2014/35/UE / Direttiva Bassa tensione 2014/35/UE / Директива по низкому напряжению 2014/35/UE
- **2014/30/EU**  
 EMV-Richtlinie 2014/30/EU / EMC Directive 2014/30/EU / Directive CEM 2014/30/UE / Directiva CEM 2014/30/UE / Direttiva EMC 2014/30/UE / Директива ЭМС 2014/30/UE
- **2011/65/EU**  
 RoHS-Richtlinie 2011/65/EU / RoHS Directive 2011/65/EU / Directive RoHS 2011/65/UE / Directiva RoHS 2011/65/UE / Direttiva RoHS 2011/65/UE / Директива RoHS 2011/65/UE

Die oben beschriebenen Produkte tragen entsprechend die Kennzeichnung CE.  
 The products described above, corresponding to this, bear the CE-mark.  
 Les produits décrits ci-dessus, en correspondance, portent l'indication CE.  
 Los productos descritos arriba, en conformidad, llevan la indicación CE.  
 I prodotti sopra descritti, conformi a quanto sopra, portano il marchio CE.  
 Данные продукты в соответствии с изложенным выше маркированы знаком CE.

1 / 2

BINDER GmbH Postfach 102 D-78502 Tuttlingen    Anschrift: BINDER GmbH Im Mittleren Ösch 5 D-78532 Tuttlingen  
 Kontakt: Telefon: +49 (0) 74 62 / 20 05 - 0 | Telefax: +49 (0) 74 62 / 20 05 - 100 | info@binder-world.com | www.binder-world.com  
 Geschäftsführung: Dipl.-Ing. Peter M. Binder | Amtsgericht Stuttgart, HRB 727150 | Sitz der Gesellschaft: Tuttlingen  
 Bankverbindung: Kreissparkasse Tuttlingen Konto-Nr.: 2266 BLZ: 643 500 70 | IBAN-Code: DE05643 500700 000002266 | SWIFT-Code: SOLA DE S1TUT  
 \$-Account 2202 611 55 | IBAN-Code: DE7464350070 0220 261155 | SWIFT-Code: SOLA DE S1TUT  
 Deutsche Bank Tuttlingen Konto-Nr.: 2 136 709 BLZ: 653 700 75 | IBAN-Code: DE56653 70075 0213670900 | SWIFT-Code: DEUT DE SS603  
 Altgeräte-Entsorgung gemäß WEEE-Reg.-Nr. DE 97004983



Die oben beschriebenen Produkte sind konform mit folgenden harmonisierten Normen:  
The products described above are in conformity with the following harmonized standards:  
Les produits décrits ci-dessus sont conformes aux normes harmonisées suivantes:  
Los productos descritos arriba cumplen con las siguientes normas:  
I prodotti sopra descritti sono conformi alle seguenti normative armonizzate:  
Продукты, указанные выше, полностью соответствуют следующим стандартам:

Sicherheit / Safety / Sécurité / Seguridad / Sicurezza / Нормативы по безопасности
<ul style="list-style-type: none"><li>• EN 61010-1:2010</li><li>• EN 61010-2-010:2014</li></ul>
EMV / EMC / CEM / CEM / EMC / ЭМС
<ul style="list-style-type: none"><li>• EN 61326-1:2013</li></ul>
RoHS
<ul style="list-style-type: none"><li>• EN 50581:2012</li></ul>

78532 Tuttlingen, 23.10.2017  
BINDER GmbH



P. M. Binder  
Geschäftsführender Gesellschafter  
Managing Director  
Directeur général  
Director general  
Direttore Generale  
Генеральный Директор





J. Bollaender  
Leiter F & E  
Director R & D  
Chef de service R&D  
Responsable I & D  
Direttore R & D  
Глава департамента R&D

2 / 2

BINDER GmbH Postfach 102 D-78502 Tuttlingen **Anschrift:** BINDER GmbH Im Mittieren Ösch 5 D-78532 Tuttlingen  
**Kontakt:** Telefon: +49 (0) 74 62 / 20 05 - 0 | Telefax: +49 (0) 74 62 / 20 05 - 100 | info@binder-world.com | www.binder-world.com  
**Geschäftsführung:** Dipl.-Ing. Peter M. Binder | Amtsgericht Stuttgart, HRB 727150 | Sitz der Gesellschaft: Tuttlingen  
**Bankverbindung:** Kreissparkasse Tuttlingen Konto-Nr.: 2266 BLZ: 643 500 70 | IBAN-Code: DE05643 500700 000002266 | SWIFT-Code: SOLA DE S1TUT  
\$-Account 2202 611 55 | IBAN-Code: DE7464350070 0220 261155 | SWIFT-Code: SOLA DE S1TUT  
Deutsche Bank Tuttlingen Konto-Nr.: 2 138 709 BLZ: 653 700 75 | IBAN-Code: DE56653 70075 0213870900 | SWIFT-Code: DEUT DE SS603  
Altgeräte-Entsorgung gemäß WEEE-Reg.-Nr. DE 37004983

## 17.5 EU Declaration of Conformity for FED

  
 Best conditions for your success

	<b>EU-Konformitätserklärung / EU Declaration of Conformity / Déclaration de conformité UE / Declaración de conformidad UE / Dichiarazione di conformità UE / Декларация соответствия EU</b>
Hersteller / Manufacturer / Fabricant / Fabricante / Fabbricante / Производитель	BINDER GmbH
Anschrift / Address / Adresse / Dirección / Indirizzo / Адрес	Im Mittleren Ösch 5, 78532 Tuttlingen, Germany
Produkt / Product / Produit / Producto / Prodotto / Продукт	Trocken- und Wärmeschränke mit Umluft Drying and heating ovens with forced convection Etuves de chauffage et de séchage à convection forcée Estufas de secado y calentamiento de convección forzada Stufe per essiccazione e riscaldamento a convezione forzata Сушильные и сухожаровые шкафы с принудительной конвекцией
Typenbezeichnung / Type / Type / Tipo / Tipo / Тип	FED 56, FED 115, FED 260, FED 720

Das oben beschriebene Produkt ist konform mit folgenden EU-Richtlinien:  
 The product described above is in conformity with the following EU Directives:  
 Le produit décrit ci-dessus est conforme aux directives UE suivantes:  
 El producto descrito arriba cumple con las siguientes directivas de la UE:  
 Il prodotto sopra descritto è conforme alle seguenti direttive UE:  
 Продукты, указанные выше, полностью соответствуют следующим EU руководствам:

- **2014/35/EU**  
 Niederspannungsrichtlinie 2014/35/EU / Low voltage directive 2014/35/EU / Directive basse tension 2014/35/UE / Directiva sobre baja tensión 2014/35/UE / Direttiva Bassa tensione 2014/35/UE / Директива по низкому напряжению 2014/35/EU
- **2014/30/EU**  
 EMV-Richtlinie 2014/30/EU / EMC Directive 2014/30/EU / Directive CEM 2014/30/UE / Directiva CEM 2014/30/UE / Direttiva EMC 2014/30/UE / Директива ЭМС 2014/30/EU
- **2011/65/EU**  
 RoHS-Richtlinie 2011/65/EU / RoHS Directive 2011/65/EU / Directive RoHS 2011/65/UE / Directiva RoHS 2011/65/UE / Direttiva RoHS 2011/65/UE / Директива RoHS 2011/65/EU

Die oben beschriebenen Produkte tragen entsprechend die Kennzeichnung CE.  
 The products described above, corresponding to this, bear the CE-mark.  
 Les produits décrits ci-dessus, en correspondance, portent l'indication CE.  
 Los productos descritos arriba, en conformidad, llevan la indicación CE.  
 I prodotti sopra descritti, conformi a quanto sopra, portano il marchio CE.  
 Данные продукты в соответствии с изложенным выше маркированы знаком CE.

1 / 2

BINDER GmbH Postfach 102 D-78502 Tuttlingen    Anschrift: BINDER GmbH Im Mittleren Ösch 5 D-78532 Tuttlingen  
 Kontakt: Telefon: +49 (0) 74 62 / 20 05 – 0 | Telefax: +49 (0) 74 62 / 20 05 – 100 | info@binder-world.com | www.binder-world.com  
 Geschäftsführung: Dipl.-Ing. Peter M. Binder | Amtsgericht Stuttgart, HRB 727150 | Sitz der Gesellschaft: Tuttlingen  
 Bankverbindung: Kreissparkasse Tuttlingen Konto-Nr.: 2266 BLZ: 643 500 70 | IBAN-Code: DE05643 500700 000002266 | SWIFT-Code: SOLA DE S1TUT  
 \$-Account 2202 611 55 | IBAN-Code: DE7464350070 0220 261155 | SWIFT-Code: SOLA DE S1TUT  
 Deutsche Bank Tuttlingen Konto-Nr.: 2 138 709 BLZ: 653 700 75 | IBAN-Code: DE56653 70075 0213870900 | SWIFT-Code: DEUT DE SS603  
 Altgeräte-Entsorgung gemäß WEEE-Reg.-Nr. DE 37004983

Die oben beschriebenen Produkte sind konform mit folgenden harmonisierten Normen:  
The products described above are in conformity with the following harmonized standards:  
Les produits décrits ci-dessus sont conformes aux normes harmonisées suivantes:  
Los productos descritos arriba cumplen con las siguientes normas:  
I prodotti sopra descritti sono conformi alle seguenti normative armonizzate:  
Продукты, указанные выше, полностью соответствуют следующим стандартам:

Sicherheit / Safety / Sécurité / Seguridad / Sicurezza / Нормативы по безопасности
<ul style="list-style-type: none"><li>• EN 61010-1:2010</li><li>• EN 61010-2-010:2014</li></ul>
EMV / EMC / CEM / CEM / EMC / ЭМС
<ul style="list-style-type: none"><li>• EN 61326-1:2013</li></ul>
RoHS
<ul style="list-style-type: none"><li>• EN 50581:2012</li></ul>

78532 Tuttlingen, 23.10.2017  
BINDER GmbH



P. M. Binder  
Geschäftsführender Gesellschafter  
Managing Director  
Directeur général  
Director general  
Direttore Generale  
Генеральный Директор



J. Bollaender  
Leiter F & E  
Director R & D  
Chef de service R&D  
Responsable I & D  
Direttore R & D  
Глава департамента R&D

2 / 2

BINDER GmbH Postfach 102 D-78502 Tuttlingen **Anschrift:** BINDER GmbH Im Mittleren Ösch 5 D-78532 Tuttlingen  
**Kontakt:** Telefon: +49 (0) 74 62 / 20 05 - 0 | Telefax: +49 (0) 74 62 / 20 05 - 100 | info@binder-world.com | www.binder-world.com  
**Geschäftsführung:** Dipl.-Ing. Peter M. Binder | Amtsgericht Stuttgart, HRB 727150 | Sitz der Gesellschaft: Tuttlingen  
**Bankverbindung:** Kreissparkasse Tuttlingen Konto-Nr.: 2266 BLZ: 643 500 70 | IBAN-Code: DE05643 500700 000002266 | SWIFT-Code: SOLA DE S1TUT  
**S-Account** 2202 611 55 | IBAN-Code: DE7464350070 0220 261155 | SWIFT-Code: SOLA DE S1TUT  
**Deutsche Bank Tuttlingen** Konto-Nr.: 2 138 709 BLZ: 653 700 75 | IBAN-Code: DE56653 70075 0213870900 | SWIFT-Code: DEUT DE SS603  
Altgeräte-Entsorgung gemäß WEEE-Reg.-Nr. DE 37004983

## 18. Product registration

# Online Product Registration

Register your BINDER now!

[www.binder-world.com/register](http://www.binder-world.com/register)

The registration is free and takes just a few seconds

Advantages:

- ▶ Short response times if service is needed
- ▶ Fair prices when relocating or installing equipment
- ▶ Calibration as required at no charge in case of recalls
- ▶ Free information on news, product upgrades and accessories

Easy registered in 3 steps:



1. List serial number here:   -

2. Go online: [www.binder-world.com/register](http://www.binder-world.com/register)

3. Register serial number



## 19. Contamination clearance certificate

### 19.1 For chambers located outside the USA and Canada

#### Declaration with regard to safety and health

Erklärung zur Sicherheit und gesundheitlichen Unbedenklichkeit

The German Ordinance on Hazardous Substances (GefStofV), and the regulations regarding safety at the workplace, require that this form be filled out for all products that are returned to us, so that the safety and health of our employees can be warranted.

Die Sicherheit und Gesundheit unserer Mitarbeiter, die Gefahrstoffverordnung GefStofV und die Vorschriften zur Sicherheit am Arbeitsplatz machen es erforderlich, dass dieses Formblatt für alle Produkte, die an uns zurückgeschickt wird.



In the absence of a completely filled out form, a repair is not possible.  
Ohne Vorliegen des vollständig ausgefüllten Formblattes ist eine Reparatur nicht möglich.

- A completely filled out form should be transmitted by Fax (+49 (0) 7462 2005 93555) or by letter in advance to us, so that this information is available before the equipment/component part arrives. A second copy of this form should accompany the equipment/component part. Eventually the carrier should be informed.

Eine vollständig ausgefüllte Kopie dieses Formblattes soll per Telefax (Nr. +49 (0) 7462 2005 93555) oder Brief vorab an uns gesandt werden, so dass die Information vorliegt, bevor das Gerät/Bauteil eintrifft. Eine weitere Kopie soll dem Gerät/Bauteil beigelegt sein. Ggf. ist auch die Spedition zu informieren.

- Incomplete information or non-conformity with this procedure will inevitably lead to substantial delays in processing. We hope you will have understanding for this measure, which lies outside of our area of influence, and that you will help us to speed up this procedure.

Unvollständige Angaben oder Nichteinhalten dieses Ablaufs führen zwangsläufig zu beträchtlichen Verzögerungen in der Abwicklung. Bitte haben Sie Verständnis für Maßnahmen, die außerhalb unserer Einflussmöglichkeiten liegen und helfen Sie mit, den Ablauf beschleunigen.

- **Please fill out this form completely.**

**Bitte unbedingt vollständig ausfüllen!**

<b>1.</b>	<b>Chamber/ component part / type: / Gerät / Bauteil / Typ:</b>
<b>2.</b>	<b>Serial No./ Serien-Nr.:</b>
<b>3.</b>	<b>Details about utilized substances / biological substances / Einzelheiten über die eingesetzten Substanzen/biologische Materialien:</b>
<b>3.1</b>	<b>Designations / Bezeichnungen:</b>
a)	_____
b)	_____
c)	_____
<b>3.2</b>	<b>Safety measures required for handling these substances / Vorsichtsmaßnahmen beim Umgang mit diesen Stoffen:</b>
a)	_____
b)	_____
c)	_____



<b>3.3</b>	<b>Measures to be taken in case of skin contact or release into the atmosphere / Maßnahmen bei Personenkontakt oder Freisetzung:</b>
a)	_____
b)	_____
c)	_____
d)	_____
<b>3.4</b>	<b>Other important information that must be taken into account / Weitere zu beachtende und wichtige Informationen:</b>
a)	_____
b)	_____
c)	_____
<b>4.</b>	<b>Declaration on the risk of these substances (please checkmark the applicable items) / Erklärung zur Gefährlichkeit der Stoffe (bitte Zutreffendes ankreuzen) :</b>
<input type="checkbox"/>	<b>4.1 For non toxic, non radioactive, biologically harmless materials / für nicht giftige, nicht radioaktive, biologisch ungefährliche Stoffe:</b>
<b>We herewith guarantee that the above-mentioned chamber / component part... / Wir versichern, dass o.g. Gerät/Bauteil...</b>	
<input type="checkbox"/>	Has not been exposed to or contains any toxic or otherwise hazardous substances / weder giftige noch sonstige gefährliche Stoffe enthält oder solche anhaften.
<input type="checkbox"/>	That eventually generated reaction products are non-toxic and also do not represent a hazard / auch evtl. entstandene Reaktionsprodukte weder giftig sind noch sonst eine Gefährdung darstellen.
<input type="checkbox"/>	Eventual residues of hazardous substances have been removed / evtl. Rückstände von Gefahrstoffen entfernt wurden.
<input type="checkbox"/>	<b>4.2 For toxic, radioactive, biologically harmful or hazardous substances, or any other hazardous materials / für giftige, radioaktive, biologisch bedenkliche bzw. gefährliche Stoffe oder anderweitig gefährliche Stoffe.</b>
<b>We herewith guarantee that ... / Wir versichern, dass ...</b>	
<input type="checkbox"/>	The hazardous substances, which have come into contact with the above-mentioned equipment/component part, have been completely listed under item 3.1 and that all information in this regard is complete / die gefährlichen Stoffe, die mit dem o.g. Gerät/Bauteil in Kontakt kamen, in 3.1 aufgelistet sind und alle Angaben vollständig sind.
<input type="checkbox"/>	That the chamber /component part has not been in contact with radioactivity / das Gerät/Bauteil nicht mit Radioaktivität in Berührung kam
<b>5.</b>	<b>Kind of transport / transporter / Transportweg/Spediteur:</b>
Transport by (means and name of transport company, etc.) Versendung durch (Name Spediteur o.ä.)	
_____	
Date of dispatch to BINDER GmbH / Tag der Absendung an BINDER GmbH:	
_____	

**We herewith declare that the following measures have been taken / Wir erklären, dass folgende Maßnahmen getroffen wurden:**

- Hazardous substances were removed from the chamber / component part, so that no hazard exists for corresponding persons in the handling or repair of these items / das Gerät/Bauteil wurde von Gefahrstoffen befreit, so dass bei Handhabung/Reparaturen für die betreffenden Person keinerlei Gefährdung besteht
- The chamber was securely packaged and properly identified / das Gerät wurde sicher verpackt und vollständig gekennzeichnet.
- Information about the hazardousness of the shipment (if required) has been provided to the transporter / der Spediteur wurde (falls vorgeschrieben) über die Gefährlichkeit der Sendung informiert.

We herewith commit ourselves and guarantee that we will indemnify BINDER GmbH for all damages that are a consequence of incomplete or incorrect information provided by us, and that we will exempt BINDER GmbH from eventual damage claims by third parties./ Wir versichern, dass wir gegenüber BINDER für jeden Schaden, der durch unvollständige und unrichtige Angaben entsteht, haften und BINDER gegen eventuell entstehende Schadenansprüche Dritter freistellen.

We are aware that, in accordance with Article 823 of the German Civil Code (BGB), we are directly liable with regard to third parties, in this instance especially the employees of BINDER GmbH, who have been entrusted with the handling / repair of the chamber / component. / Es ist uns bekannt, dass wir gegenüber Dritten – hier insbesondere mit der Handhabung/Reparatur des Geräts/des Bauteils betraute Mitarbeiter der Firma BINDER - gemäß §823 BGB direkt haften

Name: \_\_\_\_\_

Position: \_\_\_\_\_

Date / Datum: \_\_\_\_\_

Signature / Unterschrift: \_\_\_\_\_

Company stamp / Firmenstempel:



Equipment that is returned to the factory for repair must be accompanied by a completely filled out contamination clearance certificate. For service and maintenance works on site, such a contamination clearance certificate must be submitted to the service technician before the start of the works. No repair or maintenance of the equipment is possible, without a properly filled out contamination clearance certificate.

## 19.2 For chambers located in the USA and Canada

### Product Return Authorization Request

Please complete this form and the Customer Decontamination Declaration (next 2 pages) and attach the required pictures. E-mail to: IDL\_SalesOrderProcessing\_USA@binder-world.com

After we have received and reviewed the complete information we will decide on the issue of a RMA number. Please be aware that size specifications, voltage specifications as well as performance specifications are available on the internet at [www.binder-world.us](http://www.binder-world.us) at any time.

Take notice of shipping laws and regulations.

	Please fill:	
Reason for return request	<input type="radio"/> Duplicate order	
	<input type="radio"/> Duplicate shipment	
	<input type="radio"/> Demo	<i>Page one completed by sales</i>
	<input type="radio"/> Power Plug / Voltage	115V / 230 V / 208 V / 240V
	<input type="radio"/> Size does not fit space	
	<input type="radio"/> Transport Damage	Shock watch tripped? ( <i>pictures</i> )
	<input type="radio"/> Other (specify below)	
	_____	
Is there a replacement PO?	<input type="radio"/> Yes <input type="radio"/> No	
<i>If yes -&gt; PO #</i>		
<i>If yes -&gt; Date PO placed</i>		
Purchase order number		
BINDER model number		
BINDER serial number		
Date chamber was received		
Was the chamber unboxed?	<input type="radio"/> Yes <input type="radio"/> No	
Was the chamber plugged in?	<input type="radio"/> Yes <input type="radio"/> No	
Was the chamber in operation?	<input type="radio"/> Yes <input type="radio"/> No	
<i>Pictures of chamber attached?</i> <i>Pictures of Packaging attached?</i>	<input type="radio"/> Yes <input type="radio"/> No <input type="radio"/> Yes <input type="radio"/> No	Pictures have to be attached!

	Customer Contact Information	Distributor Contact Information
Name		
Company		
Address		
Phone		
E-mail		

## Customer (End User) Decontamination Declaration

### Health and Hazard Safety declaration

To protect the health of our employees and the safety at the workplace, we require that this form is completed by the user for all products and parts that are returned to us. (Distributors or Service Organizations cannot sign this form)

	<p>NO RMA number will be issued without a completed form. Products or parts returned to our NY warehouse without a RMA number will be refused at the dock.</p>
---	--

A second copy of the completed form must be attached to the outside of the shipping box.

<p><b>1. Chamber/ component part / type:</b></p>
<p><b>2. Serial No.</b></p>
<p><b>3. List any exposure to hazardous liquids, gasses or substances and radioactive material</b></p>
<p><b>3.1 List with MSDS sheets attached where available or needed (if there is not enough space available below, please attach a page):</b></p> <p>a) _____</p> <p>b) _____</p> <p>c) _____</p>
<p><b>3.2 Safety measures required for handling the list under 3.1</b></p> <p>a) _____</p> <p>b) _____</p> <p>c) _____</p>
<p><b>3.3 Measures to be taken in case of skin contact or release into the atmosphere:</b></p> <p>a) _____</p> <p>b) _____</p> <p>c) _____</p> <p>d) _____</p>
<p><b>3.4 Other important information that must be considered:</b></p> <p>a) _____</p> <p>b) _____</p> <p>c) _____</p>

**4. Declaration of Decontamination**

**For toxic, radioactive, biologically and chemically harmful or hazardous substances, or any other hazardous materials.**

**We hereby guarantee that**

- 4.1 Any hazardous substances, which have come into contact with the above-mentioned equipment / component part, have been completely listed under item 3.1 and that all information in this regard is complete.
- 4.2 That the chamber /component part has not been in contact with radioactivity
- 4.3 Any Hazardous substances were removed from the chamber / component part, so that no hazard exists for a persons in the shipping, handling or repair of these returned chamber
- 4.4 The chamber was securely packaged in the original undamaged packaging and properly identified on the outside of the packaging material with the chamber designation, the RMA number and a copy of this declaration.
- 4.5 Shipping laws and regulations have not been violated.

**I hereby commit and guarantee that we will indemnify BINDER Inc. for all damages that are a consequence of incomplete or incorrect information provided by us, and that we will indemnify and hold harmless BINDER Inc. from eventual damage claims by third parties.**

Name: \_\_\_\_\_

Position: \_\_\_\_\_

Company: \_\_\_\_\_

Address: \_\_\_\_\_

Phone #: \_\_\_\_\_

Email: \_\_\_\_\_

Date: \_\_\_\_\_

Signature: \_\_\_\_\_



Equipment returned to the NY warehouse for repair must be accompanied by a completed customer decontamination declaration. For service and maintenance works on site, such a customer decontamination declaration must be submitted to the service technician before the start of work. No repair or maintenance of the equipment is possible without a completed form.